

---

**TABLE OF CONTENTS**

---

Specifications .....	16-2
Quick Spec Guide .....	16-6
Handing Codes .....	16-10
Elevations: 1/4" Scale .....	16-11
300 Series Sliding Patio Door .....	16-13
300 Series Transom Alignment Guide .....	16-18
300 Series Sliding Patio Door Transom .....	16-19
400 Series Sliding Patio Door .....	16-21
400 Series Transom Alignment Guide .....	16-26
400 Series Sliding Patio Door Transom .....	16-27
Panel Glazing Options: 3" Scale .....	16-29
Trim Options: 3" Scale .....	16-30
Lite Cut Information .....	16-31
Clear Opening and Daylight Specifications .....	16-34
Unit Sizing, Rough Openings & Masonry Opening .....	16-37
Section Details: 6" Scale (300 Series Sliding Door) .....	16-38
Section Details: 3" Scale (300 Series Sliding Door) .....	16-46
Section Details: 6" Scale (400 Series Sliding Door) .....	16-51
Section Details: 3" Scale (400 Series Sliding Door) .....	16-58

**PRODUCT SPECIFICATIONS: 300 SLIDING PATIO DOOR****EXTERIOR FINISH**

All exterior surfaces are covered with a factory-applied latex primer.

**AURALAST® WOOD**

AuraLast® wood is fundamentally different from wood resulting from traditional millwork preservation processes in that it uses a proprietary vacuum/pressure process to provide protection throughout the wood parts used to make windows and doors. AuraLast® wood is distinguished from wood using the current preservation methods by its unique ability to achieve greater penetration of the active ingredients into the wood parts, with a penetration of the treatment being a minimum of 92%.

**INTERIOR FINISH**

All interior surfaces are unfinished clear pine ready for on site finishing. Primed and pre-finished interiors are available in paint: Pure White, Extra White, Natural Choice, Moderate White; in stain: Wheat, Cherry, Cordovan; and Clear Lacquer.

**FRAME**

Frame is assembled from select kiln dried pine using AuraLast® wood on all exterior parts. Corner joints are sealed with silicone and secured with metal fasteners. Frames are finger jointed with an option for clear on most sizes. Frame thickness is 1-7/32" (31 mm) at head and side jamb and 11/16" (17.5mm) at sill. Basic jamb width is 4-9/16" (116mm) and may be extended for different wall depths. Sill is constructed of a dark bronze one-piece pulltruded fiberglass and a bronze anodized aluminum track. An integral wrapped foam sill weather-strip provides continuous seal against water and air infiltration. Two panel and four panel (quad) doors have continuous head and sill. Three panel units have separate sidelight field muller to two-panel unit. Doors are shipped KD but factory assembly may be specified on most sizes as an option.

**PANEL**

Panel is 1-23/32" (43.7mm) thick select kiln-dried pine using AuraLast® wood and engineered wood substrate, which is water repellent preservative treated. Selected panel members have Timberstrand core for added strength and dimensional stability. Wood stiles and rails are 3-3/16" (81mm) in face width, machine clamped for square assembly, and joined with slot and tenon corners secured with metal fasteners. Operating door panel slides on inside track. Quad doors have two stationary and two operating panels with a center astragal applied to the secondary active panel. The primary active panel is the left center panel on quad doors (viewed from the building exterior) unless otherwise specified.

**GLAZING**

3/4" (19mm) thick sealed insulating glass is constructed from two panes of tempered glass, utilizing a continuous roll formed stainless steel spacer with dual seal sealant. A computer-controlled application of clear silicone is used to bed the exterior of the insulating glass into the panel. An acrylic sealant is used to bed the interior. All insulating glass units comply with the performance requirements of IGCC in accordance with either ASTM E774 or E2190.

**GLAZING OPTIONS**

3/4" insulating glass available in Low-E with Argon, Low-E, Low-E 366, Clear, Neat Glass, reflective, tinted, or obscure, tempered or other specialty glass as specified. Preserve® film is a 0.003" thick polyethylene film with a low tack acrylic adhesive applied to the glass for protection during shipping and installation. 4,000 foot elevations and higher require a capillary tube to equalize environmental stress (otherwise known as High Altitude glazing). High Altitude glazing does not allow the use of Argon as listed under glazing options.

**WEATHER-STRIPPING**

Engineered system combines a rigid vinyl parting stop weather-strip with flexible leaves at the head and side jambs. A rigid vinyl interlock is applied to the meeting stiles of both the operating and stationary panels and sealed with a thermoplastic weather-strip. The sill track incorporates a wrapped foam weather-strip which contact the bottom edge of the operating panel as well as the dense pile dust plug at the bottom of the meeting stiles. The stationary panel setting block incorporates dual durometer vinyl weather-strips. The operating panel is guided by a rigid vinyl track at the head jamb. All weather-strips except sill are Ivory colored.

**HARDWARE**

Operating panel rides on two sets of adjustable, tandem, steel ball bearing rollers. Standard handle incorporates a positive locking mechanism with adjustable throw latch and oak interior hand pull. Quad door includes dummy handle. Doors come with a brown finished wood interior handle with black exterior hand pull. Handle set is also available in Bright Brass, Antique Brass, Polished Chrome, Brushed Chrome, Powder Coat White, or Oil Rubbed Bronze finish. Optional lock cylinders are keyed Weiser and may be re-keyed locally to match other doors. Optional multi-point lock is available with solid brass handle in Bright Brass, Antique Brass, or Brushed Chrome finish. Lock cylinder for multi-point lock is standard with Schlage "C" keyway.

**EXTERIOR INSECT SCREENS**

Charcoal fiberglass screen cloth (18x16 mesh) with .040" (1mm) extruded aluminum frame. Door screen rides on a set of two adjustable steel rollers at both top and bottom of the screen and operates on outside track. Quad doors have two screens with field-applied astragal. Insect screens are intended to allow air and light in and to keep insects out. They are not intended to keep anyone or anything from falling through an open door. For safety screens or other security devices contact your local building supply retailer.

**GRILLES**

**SDL** (Simulated Divided Lites) - wood muntins permanently applied to the exterior of the insulating glass unit (not available on textured glass) in 7/8" (22mm), 1-1/8" (28.5mm), or 1-3/8" (34.9mm) widths. SDL is standard with a light bronze internal shadow bar to give a true divided lite appearance. As an option, SDL may be ordered with a silver shadow bar. Clear wood interior muntin bars match the exterior muntin width and are permanently bonded to the interior of the glass. Also available is a 2-5/16" (59mm) SDL bar, which simulates a double-hung checkrail.

**Full Surround Wood Grilles** - Rectangular unfinished clear pine wood grilles in 7/8" (22mm) are available in patterns selected by the owner.

**GBG** (Grilles between the Glass) - 5/8" (15.9mm) flat and 23/32" or 1" contour mounted between the glass panes suspended within the air cavity.

*Continued on next page*

---

**PRODUCT SPECIFICATIONS: 300 SLIDING PATIO DOOR**

---

**EXTERIOR TRIM**

1-3/32" (27.8mm) x 2" (50.8mm) brickmould. Flat casing is available as 1-3/32" (27.8mm) x 2" (50.8mm), 1-3/32" (27.8mm) x 3-1/2" (89mm), 1-3/32" (27.8mm) x 4-1/2" (114.3mm), and 1-3/32" (27.8mm) x 5-1/2" (139.7mm). The following profiled casings are available: Williamsburg 1-3/16" x 3-1/4". Cellular foam PVC (composite) is available in standard brickmould profile or 3-1/2" flat.

**EXTENSION JAMBS**

Extension jambs are shipped loose on KD doors. Extensions are applied to the interior of head and sides of the frame and are 21/32" (16.7mm) thick pine to accommodate wall depths up to 9-5/16" with one piece, and up to 12" with two pieces.

**HANDING**

Operation should be specified as left or right as viewed from building exterior.

**SILL PANS**

Molded ABS plastic sill pan system is recommended for use in all patio door installations. The JELD-WEN Premium Wood 300 Series sill pan must be specified when ordering and is field-installed prior to patio door placement.

**INSTALLATION**

Installation per JELD-WEN Installation Method for Wood Patio Doors JII007 or JII008. See [www.jeld-wen.com/resources](http://www.jeld-wen.com/resources) for instructions.

**PERFORMANCE**

**NFRC Certified** - (Rated and labeled in accordance with NFRC)

WDMA Hallmark Certified -

In accordance with **AAMA/NWWD/101/1.S.2-97**

**PRODUCT SPECIFICATIONS: 400 SLIDING PATIO DOOR****EXTERIOR FINISH**

All exterior surfaces are covered with a factory-applied latex primer.

**AURALAST® WOOD**

AuraLast® wood is fundamentally different from wood resulting from traditional millwork preservation processes in that it uses a proprietary vacuum/pressure process to provide protection throughout the wood parts used to make windows and doors. AuraLast® wood is distinguished from wood using the current preservation methods by its unique ability to achieve greater penetration of the active ingredients into the wood parts, with a penetration of the treatment being a minimum of 92%.

**INTERIOR FINISH**

All interior surfaces are unfinished clear pine ready for on site finishing. Primed and pre-finished interiors are available in paint: Pure White, Extra White, Natural Choice, Moderate White; in stain: Wheat, Cherry, Cordovan; and Clear Lacquer.

**FRAME**

Frame is assembled from select kiln dried pine using AuraLast® wood on all exterior parts. Corner joints are sealed with silicone and secured with metal fasteners. Frames are finger jointed with an option for clear on most sizes. Frame thickness is 1-7/32" (31 mm) at head and side jamb and 11/16" (17.5mm) at sill. Basic jamb width is 4-9/16" (116mm) and may be extended for different wall depths. Sill is constructed of a dark bronze one-piece pultruded fiberglass and a bronze anodized aluminum track. An integral wrapped foam sill weather-strip provides continuous seal against water and air infiltration. Two panel and four panel (quad) doors have continuous head and sill. Three panel units have separate sidelight field mullered to two-panel unit. Doors are shipped KD but factory assembly may be specified on most sizes as an option.

**PANEL**

Panel is 1-23/32" (43.7mm) thick select kiln-dried pine using AuraLast® wood and engineered wood substrate, which is water repellent preservative treated. Selected panel members have Timberstrand core for added strength and dimensional stability. Wood stiles and top rail are 4-9/16" (116mm) in face width and bottom rail is 5-5/16" (135mm) in face width on 6'8" height and 8-5/16" (211mm) on 6'11" and 8'0" heights. Panels are machine clamped to insure accurate squaring of the panel and joined with coped corners secured with multiple hardwood dowel pins. Operating door panel slides on inside track. Quad doors have two stationary and two operating panels with a center astragal applied to the secondary active panel. The primary active panel is the left center panel on quad doors (viewed from the building exterior) unless otherwise specified.

**GLAZING**

3/4" (19mm) thick sealed insulating glass is constructed from two panes of tempered glass, utilizing a continuous roll formed stainless steel spacer with dual seal sealant. A computer-controlled application of clear silicone is used to bed the exterior of the insulating glass into the panel. An acrylic sealant is used to bed the interior. All insulating glass units comply with the performance requirements of IGCC in accordance with either ASTM E774 or E2190.

**GLAZING OPTIONS**

3/4" insulating glass available in Low-E with Argon, Low-E, Low-E 366, Clear, Neat Glass, reflective, tinted, or obscure, tempered or other specialty glass as specified. Preserve® film is a 0.003" thick polyethylene film with a low tack acrylic adhesive applied to the glass for protection during shipping and installation. 4,000 foot elevations and higher require a capillary tube to equalize environmental stress (otherwise known as High Altitude glazing). High Altitude glazing does not allow the use of Argon as listed under glazing options.

**WEATHER-STRIPPING**

Engineered system combines a rigid vinyl parting stop weather-strip with flexible leaves at the head and side jambs. A rigid vinyl interlock is applied to the meeting stiles of both the operating and stationary panels and sealed with a thermoplastic weather-strip. The sill track incorporates a wrapped foam weather-strip which contact the bottom edge of the operating panel as well as the dense pile dust plug at the bottom of the meeting stiles. The stationary panel setting block incorporates dual durometer vinyl weather-strips. The operating panel is guided by a rigid vinyl track at the head jamb. All weather-strips except sill are Ivory colored.

**HARDWARE**

Operating panel rides on two sets of adjustable, tandem, steel ball bearing rollers. Standard handle incorporates a positive locking mechanism with adjustable throw latch and oak interior hand pull. Quad door includes dummy handle. Doors come with a brown finished wood interior handle with black exterior hand pull. Handle set is also available in Bright Brass, Antique Brass, Polished Chrome, Brushed Chrome, Powder Coat White, or Oil Rubbed Bronze finish. Optional lock cylinders are keyed Weiser and may be re-keyed locally to match other doors. Optional multi-point lock is available with solid brass handle in Bright Brass, Antique Brass, or Brushed Chrome finish. Lock cylinder for multi-point lock is standard with Schlage "C" keyway.

**EXTERIOR INSECT SCREENS**

Charcoal fiberglass screen cloth (18x16 mesh) with .040" (1mm) extruded aluminum frame. Door screen rides on a set of two adjustable steel rollers at both top and bottom of the screen and operates on outside track. Quad doors have two screens with field-applied astragal. Insect screens are intended to allow air and light in and to keep insects out. They are not intended to keep anyone or anything from falling through an open door. For safety screens or other security devices contact your local building supply retailer.

**GRILLES**

**SDL** (Simulated Divided Lites) - wood muntins permanently applied to the exterior of the insulating glass unit (not available on textured glass) in 7/8" (22mm), 1-1/8" (28.5mm), or 1-3/8" (34.9mm) widths. SDL is standard with a light bronze internal shadow bar to give a true divided lite appearance. As an option, SDL may be ordered with a silver shadow bar. Clear wood interior muntin bars match the exterior muntin width and are permanently bonded to the interior of the glass. Also available is a 2-5/16" (59mm) SDL bar, which simulates a double-hung checkrail.

**Full Surround Wood Grilles** - Rectangular unfinished clear pine wood grilles in 7/8" (22mm) are available in patterns selected by the owner.

**GBG** (Grilles between the Glass) - 5/8" (15.9mm) flat and 23/32" or 1" contour mounted between the glass panes suspended within the air cavity.

*Continued on next page*

---

**PRODUCT SPECIFICATIONS: 400 SLIDING PATIO DOOR**

---

**EXTERIOR TRIM**

1-3/32" (27.8mm) x 2" (50.8mm) brickmould. Flat casing is available as 1-3/32" (27.8mm) x 2" (50.8mm), 1-3/32" (27.8mm) x 3-1/2" (89mm), 1-3/32" (27.8mm) x 4-1/2" (114.3mm), and 1-3/32" (27.8mm) x 5-1/2" (139.7mm). The following profiled casings are available: 3-1/2" (89mm) and Williamsburg 1-3/16" x 3-1/4". Cellular foam PVC (composite) is available in standard brickmould profile or 3-1/2" flat.

**EXTENSION JAMBS**

Extension jambs are shipped loose on KD doors. Extensions are applied to the interior of head and sides of the frame and are 21/32" (16.7mm) thick pine to accommodate wall depths up to 9-5/16" with one piece, and up to 12" with two pieces.

**HANDING**

Operation should be specified as left or right as viewed from building exterior. 400 Series patio doors are not field reversible.

**SILL PANS**

Molded ABS plastic sill pan system is recommended for use in all patio door installations. The JELD-WEN Premium Wood 400 Series sill pan must be specified when ordering and is field-installed prior to patio door placement.

**INSTALLATION**

Installation per JELD-WEN Installation Method for Wood Patio Doors JII007 or JII008. See [www.jeld-wen.com/resources](http://www.jeld-wen.com/resources) for instructions.

**PERFORMANCE**

**NFRC Certified** - (Rated and labeled in accordance with NFRC)

WDMA Hallmark Certified -

In accordance with **AAMA/NWWDA/1011/I.S.2-97**

**QUICK SPEC GUIDE: 300 SLIDING PATIO DOOR**

SPECIFICATION	STANDARD FEATURES	OPTIONAL FEATURES <i>Some options may require additional lead times. Consult your JELD-WEN Sales Representative.</i>
<b>FRAME</b>	<ul style="list-style-type: none"> <li>Fingerjoint Wood</li> </ul>	<ul style="list-style-type: none"> <li>Clear available on most sizes</li> </ul>
<b>EXTERIOR FINISH</b>	<ul style="list-style-type: none"> <li>Primed</li> </ul>	<ul style="list-style-type: none"> <li>Natural</li> </ul>
<b>EXTERIOR TRIM</b>	<ul style="list-style-type: none"> <li>1-3/32" Brickmould</li> <li>Drip Cap</li> </ul>	<ul style="list-style-type: none"> <li>Flat Casing: 1-3/32" x 2", 3-1/2", 4-1/2", and 5-1/2"</li> <li>Williamsburg Casing: 1-3/16" x 3-1/4"</li> <li>No Brickmould Option</li> </ul>
<b>INTERIOR FINISH</b>	<ul style="list-style-type: none"> <li>Natural</li> </ul>	<ul style="list-style-type: none"> <li>Priming Available</li> </ul> <p>Pre-finished Interior Options are:</p> <ul style="list-style-type: none"> <li>Paint - Pure White, Extra White, Natural Choice, Moderate White</li> <li>Stain - Wheat, Fruitwood, Cherry, Cordovan</li> <li>Clear Lacquer</li> </ul>
<b>SIZE</b>	<ul style="list-style-type: none"> <li>Width:                             <ul style="list-style-type: none"> <li>Two Panel: 5-0, 6-0, 8-0</li> <li>Four Panel: 10-0, 12-0, 16-0</li> <li>Sidelight Width: 2-6, 3-0, 4-0</li> </ul> </li> <li>Height:                             <ul style="list-style-type: none"> <li>6-8, 6-11, 8-0</li> </ul> </li> </ul>	<ul style="list-style-type: none"> <li>Minimum Width: 5-0      Maximum Width: 8-0</li> <li>Minimum Width: 9-10      Maximum Width: 16-0</li> <li>Minimum Width: 1-5      Maximum Width: 4-0</li> <li>Minimum Height: 2-0      Maximum Height: 8-0</li> </ul>
<b>GLAZING</b>	<ul style="list-style-type: none"> <li>Tempered Low-E Insulating Glass</li> <li>Preserve® Protective Film</li> </ul>	<ul style="list-style-type: none"> <li>Clear</li> <li>Obscure</li> <li>Bronze</li> <li>Low-E 366</li> <li>Neat Glass</li> <li>Reflective</li> <li>Tempered</li> </ul>
<b>GRILLES</b>		<ul style="list-style-type: none"> <li>High Altitude</li> <li>5/8" Flat, 23/32" or 1" Contour GBG</li> <li>7/8" Full Surround Wood Grilles</li> </ul> <p>SDL Bead Profile:</p> <ul style="list-style-type: none"> <li>7/8", 1-1/8", 1-3/8", 2-5/16" with Light Bronze Shadow Bar</li> <li>7/8", 1-1/8", 1-3/8", 2-5/16" with Silver Shadow Bar</li> </ul>
<b>HARDWARE</b>	<ul style="list-style-type: none"> <li>Single Point Lock</li> </ul>	<ul style="list-style-type: none"> <li>Multi Point Available</li> </ul>

*Continued on next page*

**QUICK SPEC GUIDE: 300 SLIDING PATIO DOOR**

SPECIFICATION	STANDARD FEATURES	OPTIONAL FEATURES <i>Some options may require additional lead times. Consult your JELD-WEN Sales Representative.</i>
<b>HANDLESET</b>	<ul style="list-style-type: none"> <li>Doors come with a single point brown finished wood interior handle with black exterior hand pull.</li> </ul>	<ul style="list-style-type: none"> <li>Optional lock cylinders keyed Schlage &amp; may be re-keyed.</li> <li>Single Point Legacy Handle set is also available in Polished Brass, Antique Brass, Polished Chrome, Brushed Chrome, Powder Coat White or Oil Rubbed Bronze finish.</li> <li>Optional foot-activated security lock.</li> <li>Optional multi-point lock is available with solid brass handle in Polished Brass, Antique Brass, Brushed Chrome or Oil Rubbed Bronze finish.</li> </ul>
<b>SILL</b>	<ul style="list-style-type: none"> <li>Dark bronze one-piece pultruded fiberglass and oak threshold</li> </ul>	<ul style="list-style-type: none"> <li>Sill Pan Available</li> </ul>
<b>HANDING</b>	<ul style="list-style-type: none"> <li>Viewed from the outside</li> <li>Door Ships KD on 2-Panel and Quad doors</li> <li>3-Panel doors and sidelights will ship Factory Setup</li> </ul>	<ul style="list-style-type: none"> <li>Door Factory Assembly Available on 2-Panel doors</li> </ul>
<b>JAMB</b>	<ul style="list-style-type: none"> <li>4-9/16"</li> </ul>	<ul style="list-style-type: none"> <li>Minimum: 4-9/16"</li> <li>Maximum: 9-5/16" (one piece) Loose</li> <li>Maximum: 12" (two piece) Loose</li> </ul>
<b>SCREENS</b>	<ul style="list-style-type: none"> <li>Fiberglass</li> <li>Extruded Aluminum Frame</li> </ul>	
<b>SCREEN FRAME COLOR</b>	<ul style="list-style-type: none"> <li>Brilliant White</li> <li>Chestnut Bronze</li> <li>Desert Sand</li> <li>French Vanilla</li> <li>Mesa Red</li> <li>Hartford Green</li> <li>Black</li> <li>Arctic Silver</li> <li>Dark Chocolate</li> </ul>	

**QUICK SPEC GUIDE: 400 SLIDING PATIO DOOR**

SPECIFICATION	STANDARD FEATURES	OPTIONAL FEATURES <i>Some options may require additional lead times. Consult your JELD-WEN Sales Representative.</i>
<b>FRAME</b>	<ul style="list-style-type: none"> <li>Fingerjoint Wood</li> </ul>	<ul style="list-style-type: none"> <li>Clear available on most sizes</li> </ul>
<b>EXTERIOR FINISH</b>	<ul style="list-style-type: none"> <li>Primed</li> </ul>	<ul style="list-style-type: none"> <li>Natural</li> </ul>
<b>EXTERIOR TRIM</b>	<ul style="list-style-type: none"> <li>1-3/32" Brickmould</li> <li>Drip Cap</li> </ul>	<ul style="list-style-type: none"> <li>Flat Casing: 1-3/32" x 2", 3-1/2", 4-1/2", and 5-1/2"</li> <li>Williamsburg Casing: 1-3/16" x 3-1/4"</li> <li>No Brickmould Option</li> </ul>
<b>INTERIOR FINISH</b>	<ul style="list-style-type: none"> <li>Natural</li> </ul>	<ul style="list-style-type: none"> <li>Priming Available</li> </ul> <p>Pre-finished Interior Options are:</p> <ul style="list-style-type: none"> <li>Paint - Pure White, Extra White, Natural Choice, Moderate White</li> <li>Stain - Wheat, Fruitwood, Cherry, Cordovan</li> <li>Clear Lacquer</li> </ul>
<b>SIZE</b>	<ul style="list-style-type: none"> <li>Width: Two Panel: 5-0, 6-0, 8-0 (Std) Four Panel: 10-0, 12-0, 16-0 Sidelight Width: 2-6, 3-0, 4-0</li> <li>Height: 6-8, 6-11, 8-0</li> </ul>	<ul style="list-style-type: none"> <li>Minimum Width: 5-0      Maximum Width: 8-0</li> <li>Minimum Width: 9-0      Maximum Width: 16-0</li> <li>Minimum Width: 1-5      Maximum Width: 4-0</li> <li>Minimum Height: 2-0      Maximum Height: 8-0</li> </ul>
<b>GLAZING</b>	<ul style="list-style-type: none"> <li>Tempered Low-E Insulating Glass</li> <li>Preserve® Protective Film</li> </ul>	<ul style="list-style-type: none"> <li>Clear</li> <li>Obscure</li> <li>Bronze</li> <li>Low-E 366</li> </ul>
		<ul style="list-style-type: none"> <li>Neat Glass</li> <li>Reflective</li> <li>Tempered</li> </ul>
<b>GRILLES</b>		<ul style="list-style-type: none"> <li>5/8" Flat, 23/32" or 1" Contour GBG</li> <li>7/8" Full Surround Wood Grilles</li> </ul> <p>SDL Bead Profile:</p> <ul style="list-style-type: none"> <li>7/8", 1-1/8", 1-3/8", 2-5/16" with Light Bronze Shadow Bar</li> <li>7/8", 1-1/8", 1-3/8", 2-5/16" with Silver Shadow Bar</li> </ul>
<b>HARDWARE</b>	<ul style="list-style-type: none"> <li>Single Point Lock</li> </ul>	<ul style="list-style-type: none"> <li>Multi Point Available</li> </ul>

*Continued on next page*



**QUICK SPEC GUIDE: 400 SLIDING PATIO DOOR**

SPECIFICATION	STANDARD FEATURES	OPTIONAL FEATURES <i>Some options may require additional lead times. Consult your JELD-WEN Sales Representative.</i>
<b>HANDLESET</b>	<ul style="list-style-type: none"> <li>Doors come with a single point brown finished wood interior handle with black exterior hand pull.</li> </ul>	<ul style="list-style-type: none"> <li>Optional lock cylinders keyed Schlage &amp; may be re-keyed.</li> <li>Single Point Legacy Handle set is also available in Polished Brass, Antique Brass, Polished Chrome, Brushed Chrome, Powder Coat White or Oil Rubbed Bronze finish.</li> <li>Optional foot-activated security lock.</li> <li>Optional multi-point lock is available with solid brass handle in Polished Brass, Antique Brass, Brushed Chrome or Oil Rubbed Bronze finish.</li> </ul>
<b>SILL</b>	<ul style="list-style-type: none"> <li>Dark bronze one-piece pultruded fiberglass and oak threshold</li> </ul>	<ul style="list-style-type: none"> <li>Sill Pan Available</li> </ul>
<b>HANDING</b>	<ul style="list-style-type: none"> <li>Viewed from the outside</li> <li>Door Ships KD on 2-Panel and Quad doors</li> <li>3-Panel doors and sidelights will ship Factory Setup</li> </ul>	<ul style="list-style-type: none"> <li>Door Factory Assembly Available on 2-Panel doors</li> </ul>
<b>JAMB</b>	<ul style="list-style-type: none"> <li>4-9/16"</li> </ul>	<ul style="list-style-type: none"> <li>Minimum: 4-9/16"</li> <li>Maximum: 9-5/16" (one piece) Loose</li> <li>Maximum: 12" (two piece) Loose</li> </ul>
<b>SCREENS</b>	<ul style="list-style-type: none"> <li>Fiberglass</li> <li>Extruded Aluminum Frame</li> </ul>	
<b>SCREEN FRAME COLOR</b>	<ul style="list-style-type: none"> <li>Brilliant White</li> <li>Chestnut Bronze</li> <li>Desert Sand</li> <li>French Vanilla</li> <li>Mesa Red</li> <li>Hartford Green</li> <li>Black</li> <li>Arctic Silver</li> <li>Dark Chocolate</li> </ul>	

**HANDING CODES**

**300 AND 400 SERIES**

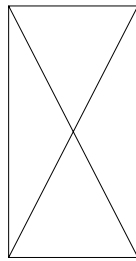

**STAT ONLY**

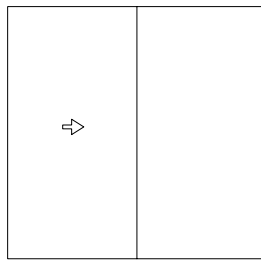

**ACTIVE STAT**  
**SL-1**

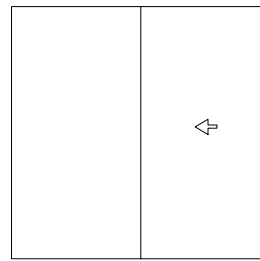

**STAT ACTIVE**  
**SL-2**

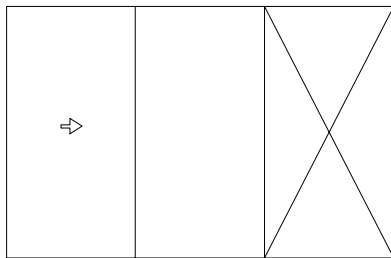

**ACTIVE STAT SIDE**  
**SL-3**

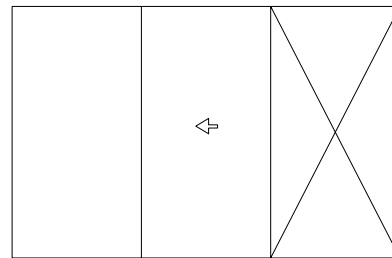

**STAT ACTIVE SIDE**  
**SL-4**

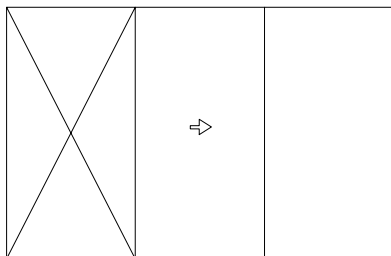

**SIDE ACTIVE STAT**  
**SL-5**

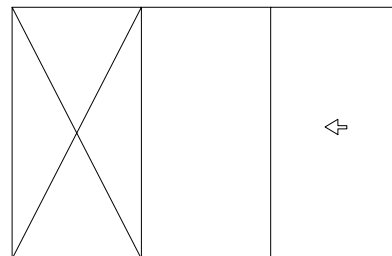

**SIDE STAT ACTIVE**  
**SL-6**

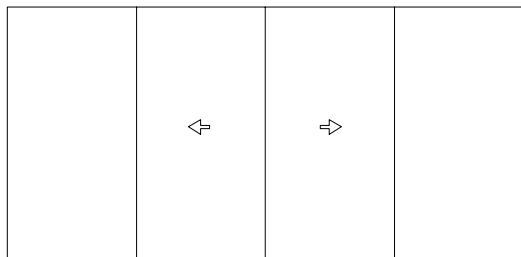

**STAT PRIMARY SECND STAT**  
**SL-7**

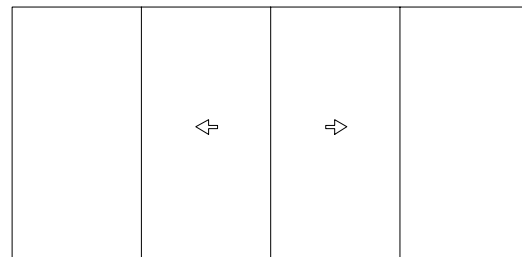

**STAT SECND PRIMARY STAT**  
**SL-8**

**Note:** Doors pictured as viewed from the exterior.

**GENERAL INFORMATION**

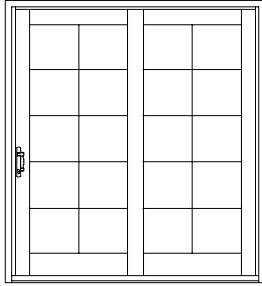

RIGHT STATIONARY

**DIMENSIONAL DOORS**

Wood Sliding patio doors may be specified as "dimensional", by adjusting the desired rough opening width or height in 1/4" increments from standard.

Wood Sliding patio doors are available in single, twin, triple and quad panel doors.

**OPERATION**

Wood Sliding patio doors are available in a full range of operating and stationary styles. Single panel doors are only available as stationary (non-venting) styles. Two-panel doors are available with left or right operation. Three-panel doors are available with left and right operation and with center or end operators. Four-panel doors are available with two panels operating from the center. Configuration and handing is based on viewing the door from the exterior.

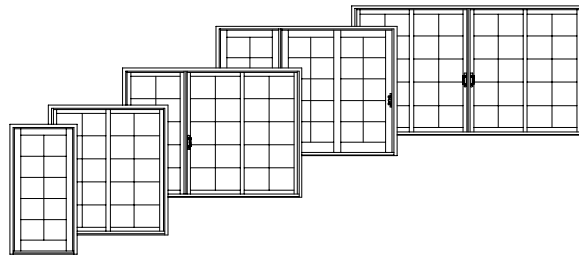

**MULTIPLE ASSEMBLIES**

Wood Sliding patio doors are available in a wide variety of multiple panel configurations from the factory, all of which are assembled with continuous sills. Mulling of Wood Sliding patio doors to like products in the field is not recommended. Instead, individual factory assembled units should be installed in contiguous rough openings, in order to provide adequate framing support to assure the best performance of the door systems.

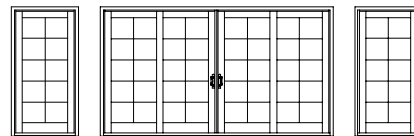
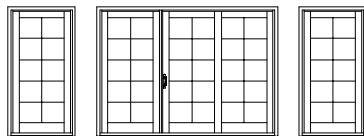
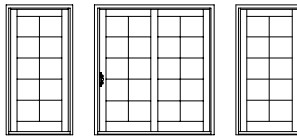

**ELEVATION NOTES**

ELEVATION DRAWINGS UTILIZE A LIMITED NUMBER OF PROJECTED LINES TO PRODUCE A RUDIMENTARY DRAWING INTENDED TO BE USED IN A SMALL GRAPHICAL SCALE. ELEVATIONS ARE VIEWED PERPENDICULAR FROM THE EXTERIOR OF THE STRUCTURE. IF MORE DIMENSIONS ARE NEEDED, USE SECTION DRAWINGS FOR MORE COMPLETE DEPICTIONS.

UNIT	2'-11"
RSO	2'-9 1/2"
FRAME	2'-8 3/4"
GLASS	24 5/8"

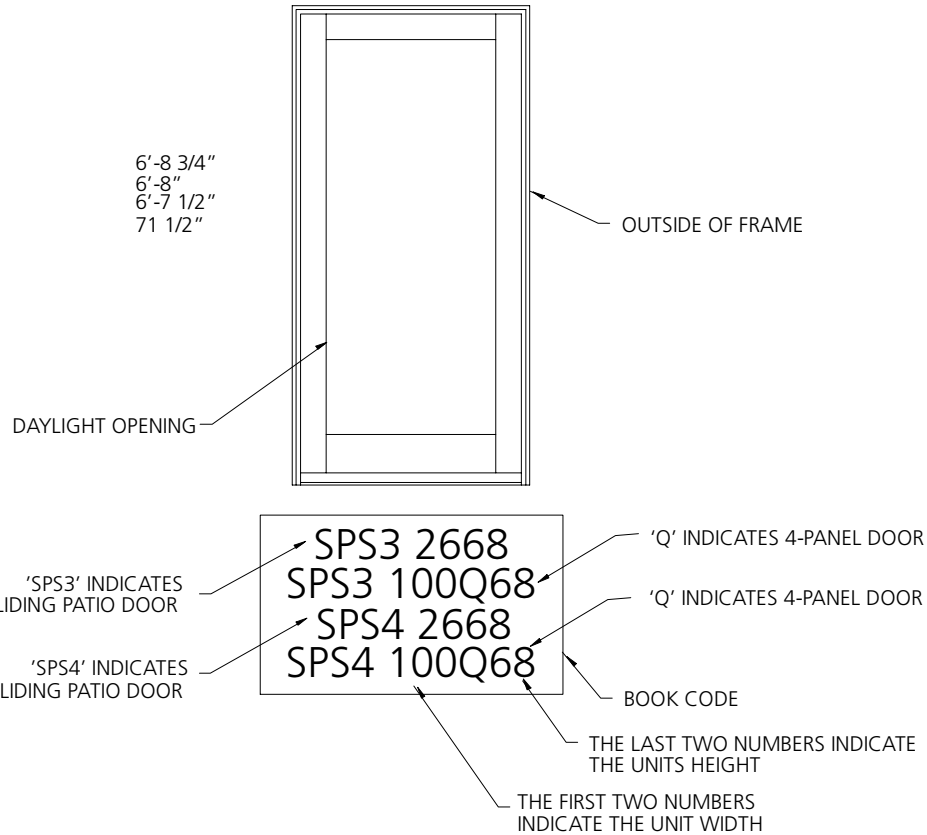

**GENERAL GLIDING DOOR NOTES**

1. WOOD SLIDING PATIO DOOR UNITS ARE AVAILABLE AS OPERATING OR FIXED UNITS.
2. UNIT ELEVATIONS ARE SHOWN WITH BRICKMOULD.
3. OPERATING UNITS ARE AVAILABLE AS LEFT OR RIGHT HAND OPERATION.
4. INTERMEDIATE LOCK RAILS, RAISED PANELS AND 10 1/4" BOTTOM RAILS ARE AVAILABLE ON ALL WIDE STYLE UNITS.

**300 SERIES SLIDING PATIO DOORS**

**UNIT**  
**RSO**  
**FRAME**  
**GLASS**

2'-11"  
2'-9 1/2"  
2'-8 3/4"  
24 5/8"

5'-2 1/4"  
5'-0 3/4"  
5'-0"  
24 5/8"

7'-11"  
7'-9 1/2"  
7'-8 3/4"  
24 5/8"

6'-8 3/4"  
6'-8"  
6'-7 1/2"  
71 1/2"

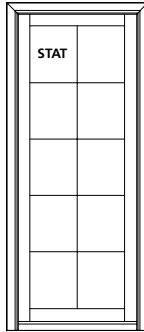

SPS3 2668

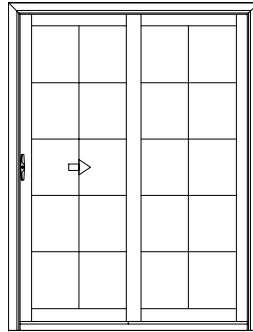

SPS3 5068

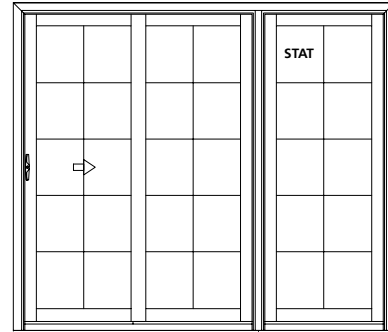

SPS3 7668

6'-11 3/4"  
6'-11"  
6'-10 1/2"  
74 1/2"

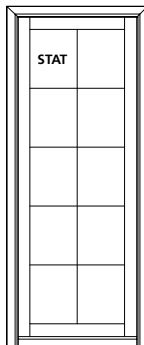

SPS3 26611

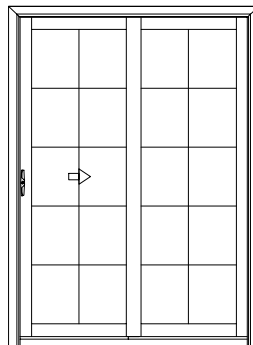

SPS3 50611

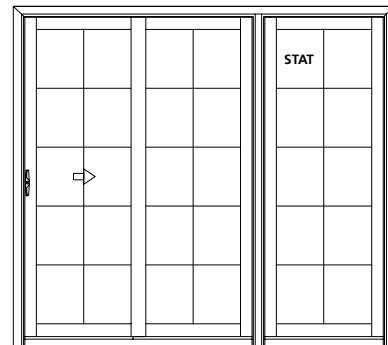

SPS3 76611

8'-0 3/4"  
8'-0"  
7'-11 1/2"  
87 1/2"

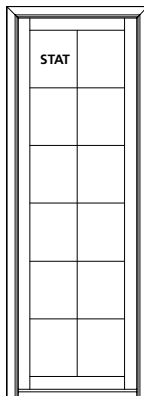

SPS3 2680

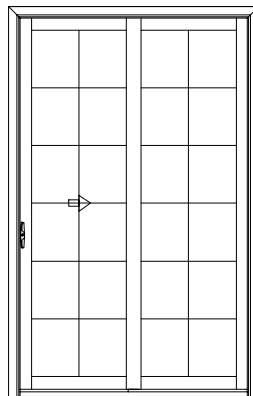

SPS3 5080

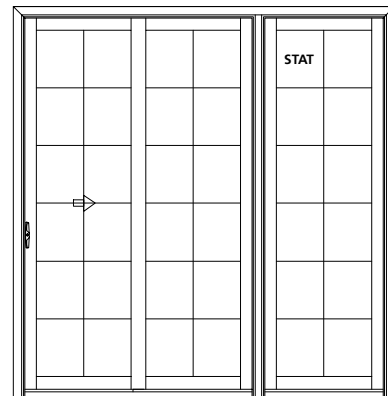

SPS3 7680

**Note:** See page NO TAG to specify handing.  
6-8 and 6-11 300 Series doors are field reversible when shipped KD.

SCALE 1/4" = 1'

**300 SERIES SLIDING PATIO DOORS**

**UNIT**  
**RSO**  
**FRAME**  
**GLASS**

3'-5"  
3'-3 1/2"  
3'-2 3/4"  
30 5/8"

6'-2 1/4"  
6'-0 3/4"  
6'-0"  
30 5/8"

9'-5"  
9'-3 1/2"  
9'-2 3/4"  
30 5/8"

6'-8 3/4"  
6'-8"  
6'-7 1/2"  
71 1/2"

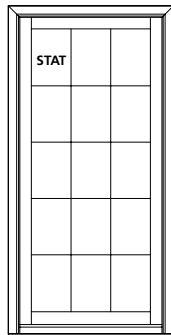

SPS3 3068

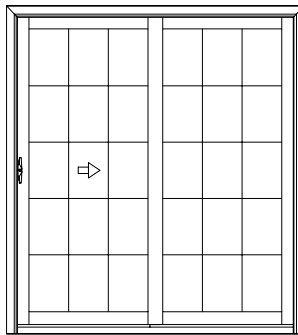

SPS3 6068

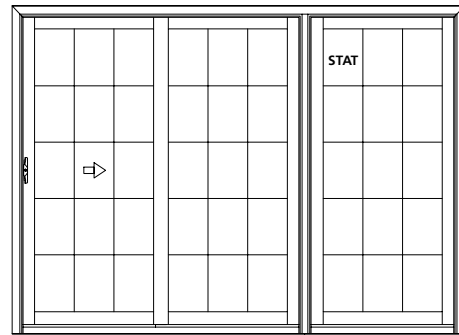

SPS3 9068

6'-11 3/4"  
6'-11"  
6'-10 1/2"  
74 1/2"

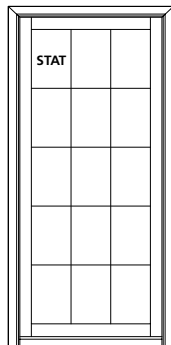

SPS3 30611

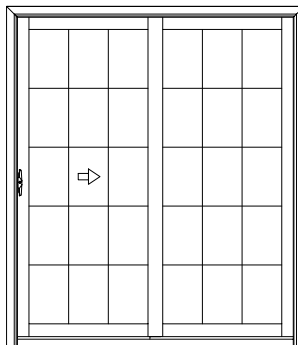

SPS3 60611

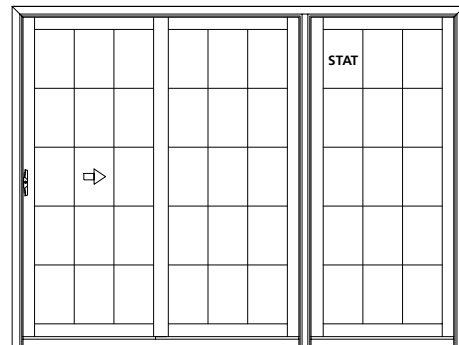

SPS3 90611

8'-0 3/4"  
8'-0"  
7'-11 1/2"  
87 1/2"

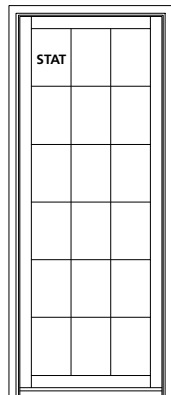

SPS3 3080

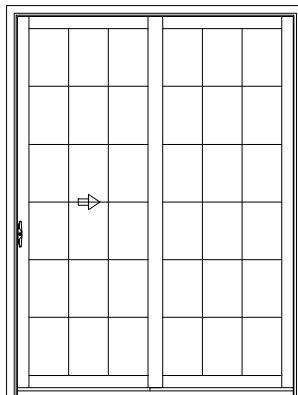

SPS3 6080

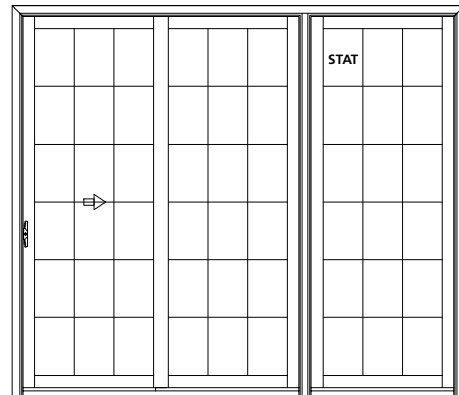

SPS3 9080

**Note:** See page NO TAG to specify handing.  
6-8 and 6-11 300 Series doors are field reversible when shipped KD.

SCALE 1/4" = 1'

**300 SERIES SLIDING PATIO DOORS**

UNIT  
RSO  
FRAME  
GLASS

4'-5"  
4'-3 1/2"  
4'-2 3/4"  
42 5/8"

8'-2 1/4"  
8'-0 3/4"  
8'-0"  
42 5/8"

12'-5"  
12'-3 1/2"  
12'-2 3/4"  
42 5/8"

6'-8 3/4"  
6'-8"  
6'-7 1/2"  
74 1/2"

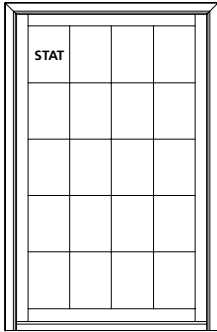

SPS3 4068

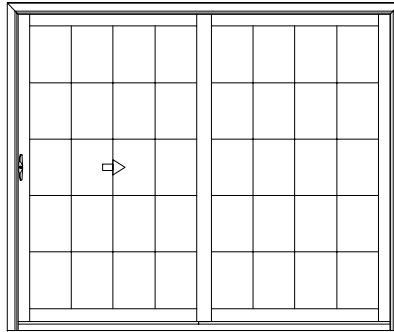

SPS3 8068

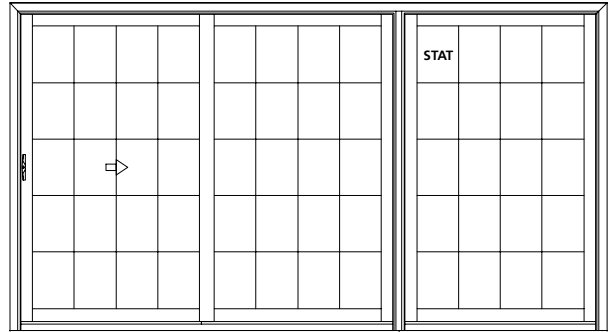

SPS3 12068

6'-11 3/4"  
6'-11"  
6'-10 1/2"  
74 1/2"

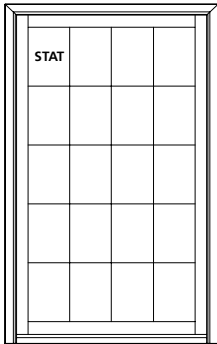

SPS3 40611

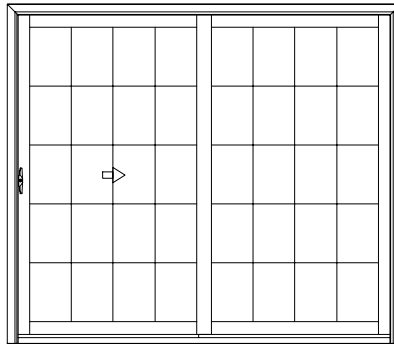

SPS3 80611

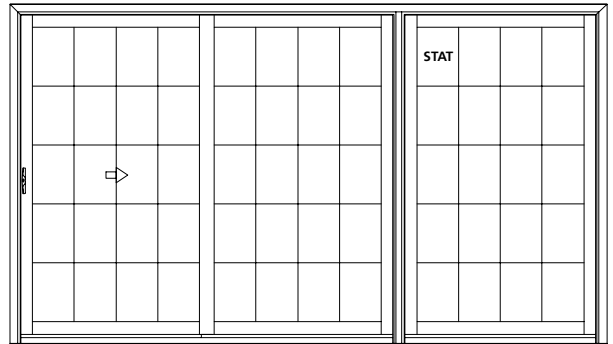

SPS3 120611

8'-0 3/4"  
8'-0"  
7'-11 1/2"  
87 1/2"

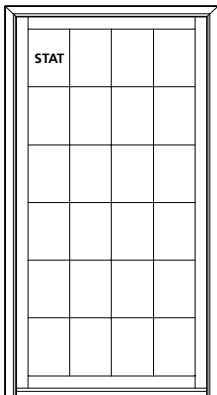

SPS3 4080

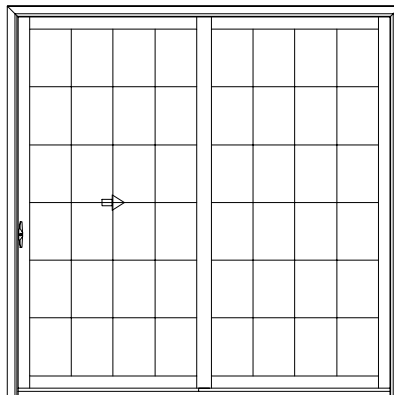

SPS3 8080

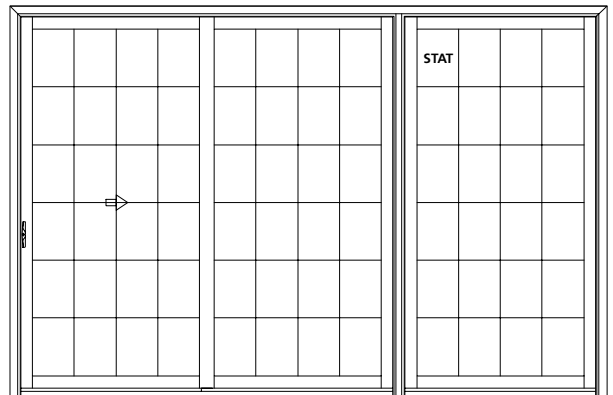

SPS3 12080

**Note:** See page NO TAG to specify handing.  
6-8 and 6-11 300 Series doors are field reversible when shipped KD.

SCALE 1/4" = 1'

**300 SERIES 4-PANEL SLIDING PATIO DOORS**

**UNIT**  
**RSO**  
**FRAME**  
**GLASS**

10'-0 1/4"  
9'-10 3/4"  
9'-10"  
24 5/8"

12'-0 1/4"  
11'-10 3/4"  
11'-10"  
30 5/8"

6'-8 3/4"  
6'-8"  
6'-7 1/2"  
71 1/2"

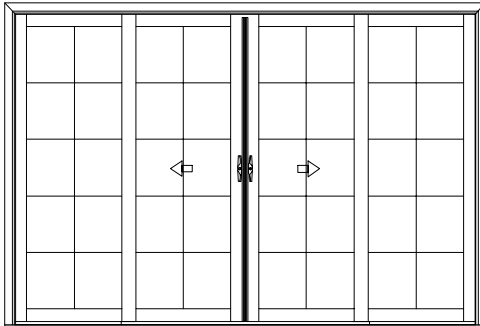

SPS3 100Q68

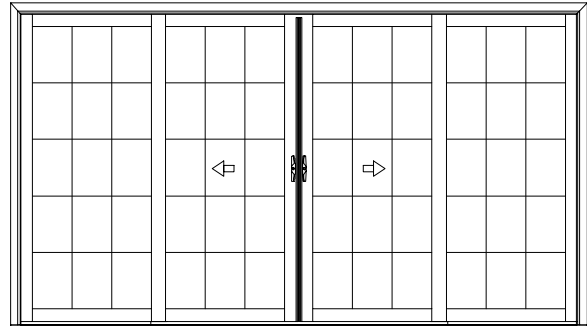

SPS3 120Q68

6'-11 3/4"  
6'-11"  
6'-10 1/2"  
74 1/2"

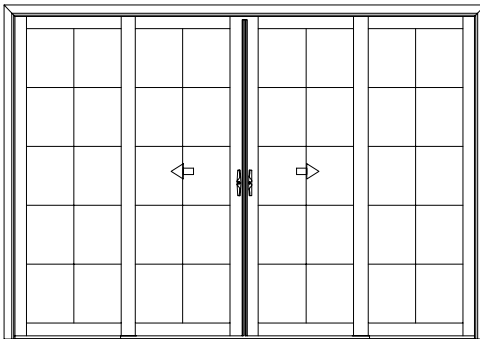

SPS3 100Q611

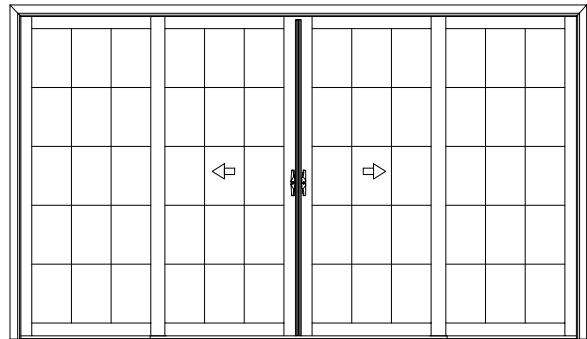

SPS3 120Q611

8'-0 3/4"  
8'-0"  
7'-11 1/2"  
87 1/2"

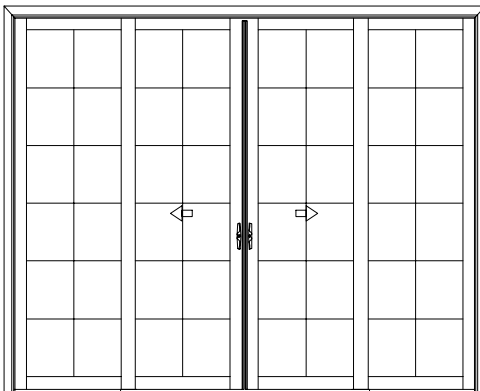

SPS3 100Q80

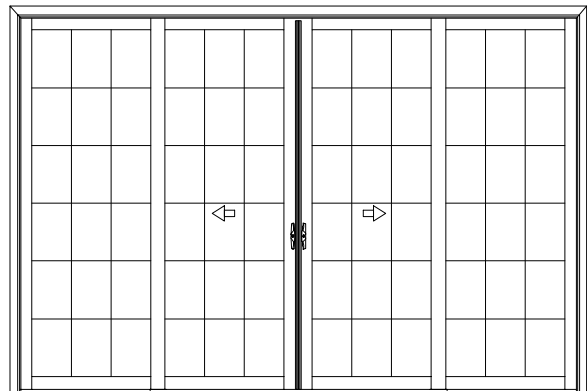

SPS3 120Q80

**Note:** See page NO TAG to specify handing.  
4-Panel doors are not field reversible.

SCALE 1/4" = 1'



**300 SERIES 4-PANEL SLIDING PATIO DOORS**

UNIT  
RSO  
FRAME  
GLASS

16'-0 1/4"  
15'-10 3/4"  
15'-10"  
42 5/8"

6'-8 3/4"  
6'-8"  
6'-7 1/2"  
71 1/2"

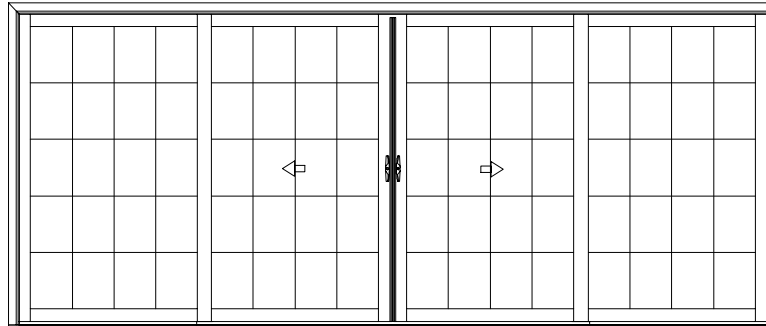

SPS3 160Q68

6'-11 3/4"  
6'-11"  
6'-10 1/2"  
74 1/2"

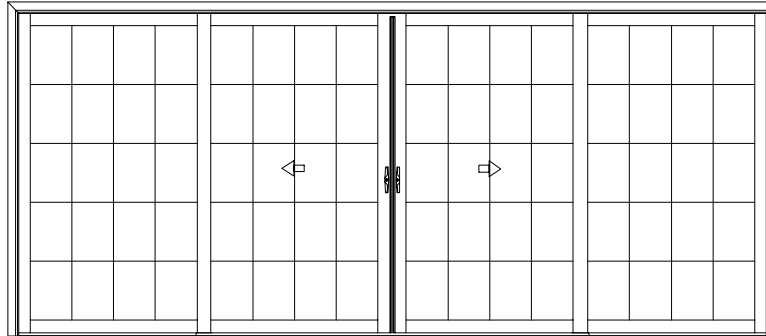

SPS3 160Q611

8'-0 3/4"  
8'-0"  
7'-11 1/2"  
87 1/2"

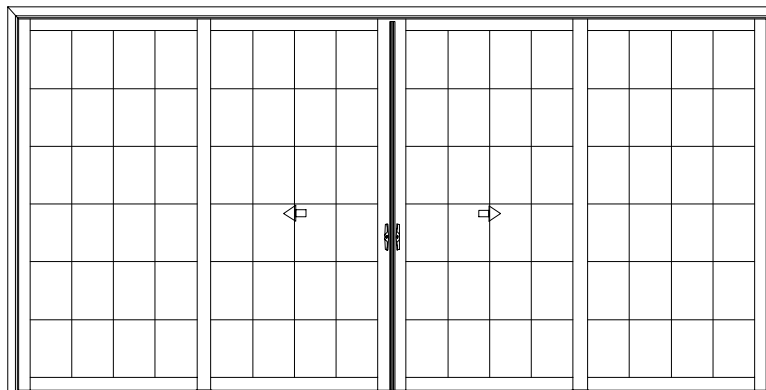

SPS3 160Q80

**Note:** See page NO TAG to specify handing.  
4-Panel doors are not field reversible.

SCALE 1/4" = 1'

**300 SERIES TRANSOM ALIGNMENT GUIDE**

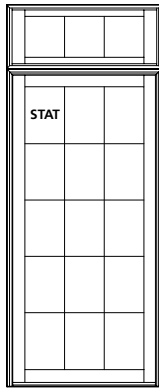

ONE PANEL TRANSOM

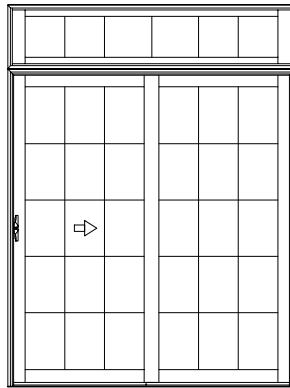

ONE PANEL TRANSOM

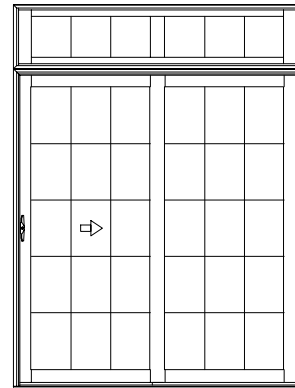

ONE PANEL (2-LITE) TRANSOM

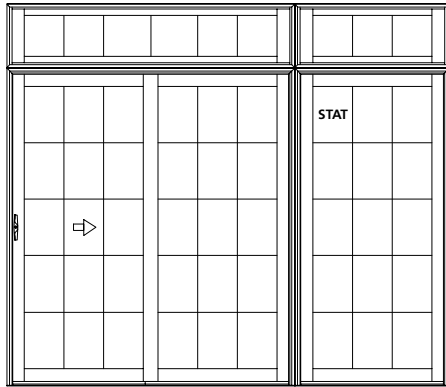

ONE PANEL TRANSOM

ONE PANEL TRANSOM

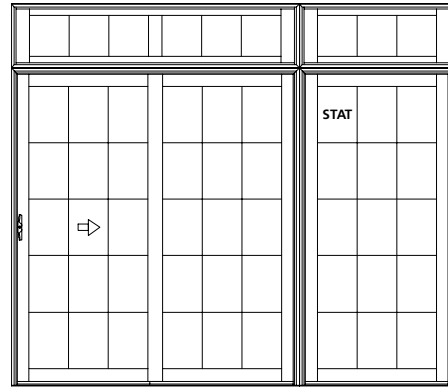

ONE PANEL (2-LITE) TRANSOM

ONE PANEL TRANSOM

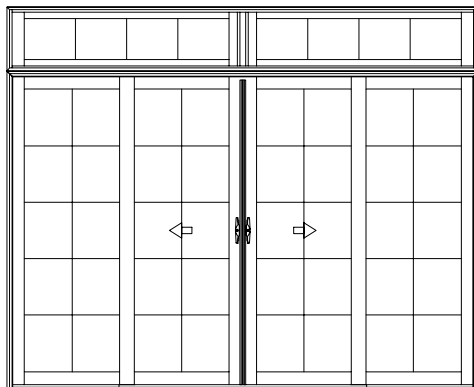



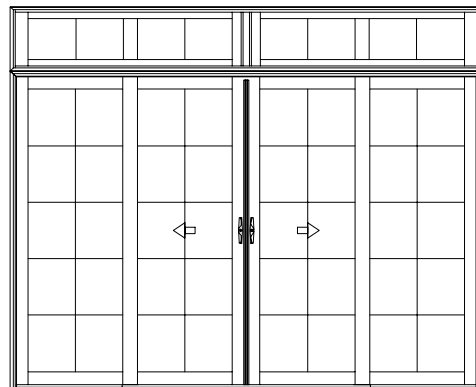









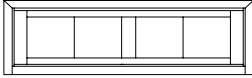

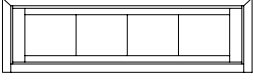
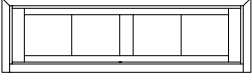
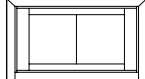
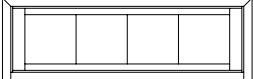
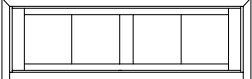
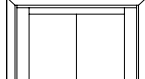
QUAD 2-PANEL TRANSOM  
AVAILABLE ON 10-0 & 12-0 WIDTHS ONLY

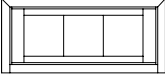
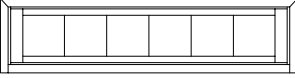
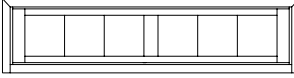
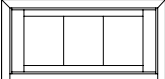
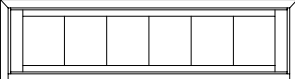
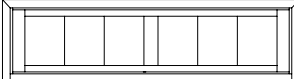

QUAD 2-PANEL (4-LITE) TRANSOM  
(WILL ALIGN WITH INTERLOCKS ON QUAD DOOR)  
AVAILABLE ON 10-0 & 12-0 WIDTHS ONLY

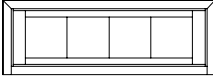
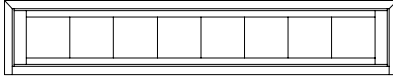
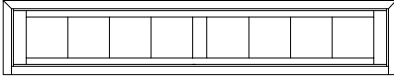
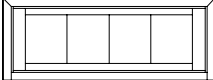
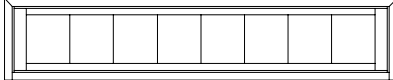
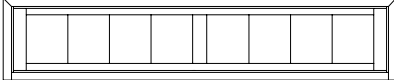
SCALE 1/4" = 1'

**300 SERIES SLIDING DOOR TRANSOMS**

			
<b>ONE PANEL TRANSOM</b>			
<b>UNIT</b>	2'-11"	5'-2 1/4"	5'-2 1/4"
<b>RSO</b>	2'-9 1/2"	5'-0 3/4"	5'-0 3/4"
<b>FRAME</b>	2'-8 3/4"	5'-0"	5'-0"
<b>GLASS</b>	24 5/8"	52 1/16"	24 5/8"
1'-6 1/16" 1'-4 1/2" 1'-4" 11 1/16"			
	SPS3 2614-1	SPS3 5014-1	SPS3 5014-2
1'-8 1/16" 1'-6 1/2" 1'-6" 13 1/16"			
	SPS3 2616-1	SPS3 5016-1	SPS3 5016-2
2'-2 1/16" 2'-0 1/2" 2'-0" 19 1/16"			
	SPS3 2620-1	SPS3 5020-1	SPS3 5020-2
<b>UNIT</b>	3'-5"	6'-2 1/4"	6'-2 1/4"
<b>RSO</b>	3'-3 1/2"	6'-0 3/4"	6'-0 3/4"
<b>FRAME</b>	3'-2 3/4"	6'-0"	6'-0"
<b>GLASS</b>	30 5/8"	64 1/16"	30 5/8"
1'-6 1/16" 1'-4 1/2" 1'-4" 11 1/16"			
	SPS3 3014-1	SPS3 6014-1	SPS3 6014-2
1'-8 1/16" 1'-6 1/2" 1'-6" 13 1/16"			
	SPS3 3016-1	SPS3 6016-1	SPS3 6016-2
2'-2 1/16" 2'-0 1/2" 2'-0" 19 1/16"			
	SPS3 3020-1	SPS3 6020-1	SPS3 6020-2
<b>UNIT</b>	4'-5"	8'-2 1/4"	8'-2 1/4"
<b>RSO</b>	4'-3 1/2"	8'-0 3/4"	8'-0 3/4"
<b>FRAME</b>	4'-2 3/4"	8'-0"	8'-0"
<b>GLASS</b>	42 5/8"	88 1/16"	42 5/8"
1'-6 1/16" 1'-4 1/2" 1'-4" 11 1/16"			
	SPS3 4014-1	SPS3 8014-1	SPS3 8014-2
1'-8 1/16" 1'-6 1/2" 1'-6" 13 1/16"			
	SPS3 4016-1	SPS3 8016-1	SPS3 8016-2
2'-2 1/16" 2'-0 1/2" 2'-0" 19 1/16"			
	SPS3 4020-1	SPS3 8020-1	SPS3 8020-2

\*Note: See Horizontal Section on page 16-50 for post detail.

SCALE 1/4" = 1'

**300 SERIES 4-PANEL SLIDING DOOR TRANSOMS**

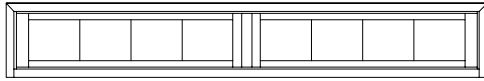

**ONE PANEL (2-LITE) TRANSOM**

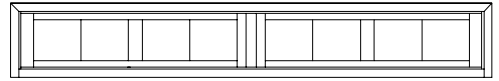

**2 PANEL (4-LITE) TRANSOM\***  
(WILL LINE UP WITH INTERLOCKS ON QUAD DOOR)

**UNIT** 10'-0 1/4"  
**RSO** 9'-10 3/4"  
**FRAME** 9'-10"  
**GLASS** 52 1/16"

10'-0 1/4"  
9'-10 3/4"  
9'-10"  
24 5/8"

1'-6 1/16"  
1'-4 1/2"  
1'-4"  
11 1/16"

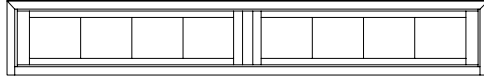

SPS3 10014-2

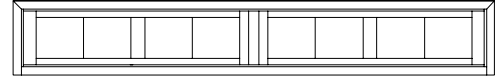

SPS3 10014-4

1'-8 1/16"  
1'-6 1/2"  
1'-6"  
13 1/16"

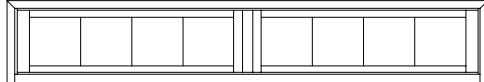

SPS3 10016-2

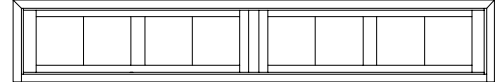

SPS3 10016-4

2'-2 1/16"  
2'-0 1/2"  
2'-0"  
19 1/16"

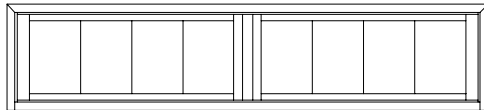

SPS3 10020-2

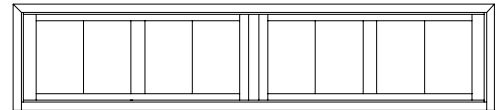

SPS3 10020-4

**UNIT** 12'-0 1/4"  
**RSO** 11'-10 3/4"  
**FRAME** 11'-10"  
**GLASS** 64 1/16"

12'-0 1/4"  
11'-10 3/4"  
11'-10"  
30 5/8"

1'-6 1/16"  
1'-4 1/2"  
1'-4"  
11 1/16"

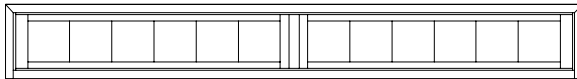

SPS3 12014-2

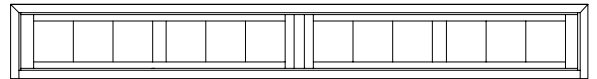

SPS3 12014-4

1'-8 1/16"  
1'-6 1/2"  
1'-6"  
13 1/16"

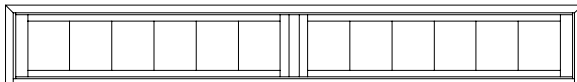

SPS3 12016-2

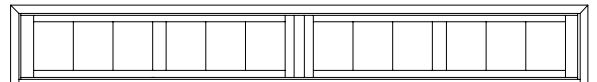

SPS3 12016-4

2'-2 1/16"  
2'-0 1/2"  
2'-0"  
19 1/16"

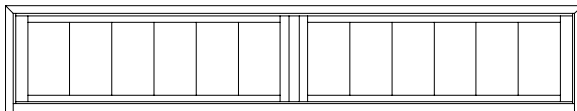

SPS3 12020-2

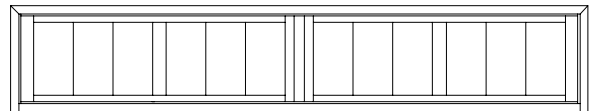

SPS3 12020-4

\*Note: See Horizontal Section on page 16-50 for post detail.

SCALE 1/4" = 1'

**400 SERIES SLIDING PATIO DOORS**

**UNIT** 2'-11 11/16"  
**RSO** 2'-10 3/16"  
**FRAME** 2'-9 7/16"  
**GLASS** 22 9/16"

5'-2 1/4"  
5'-0 3/4"  
5'-0"  
22 9/16"

7'-11 11/16"  
7'-10 3/16"  
7'-9 7/16"  
22 9/16"

6'-8 3/4"  
6'-8"  
6'-7 1/2"  
68"

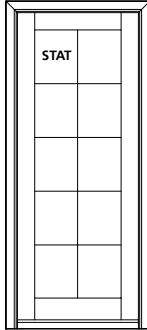

SPS4 2668

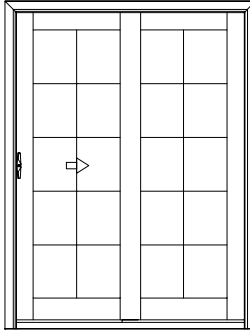

SPS4 5068

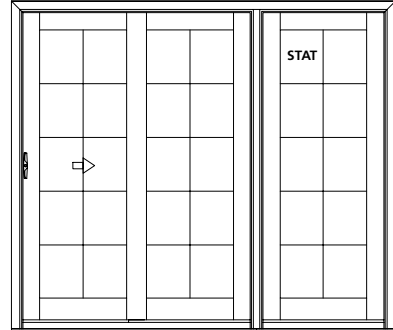

SPS4 7668

6'-11 3/4"  
6'-11"  
6'-10 1/2"  
68"

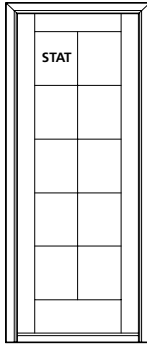

SPS4 26611

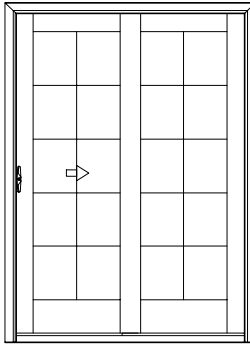

SPS4 50611

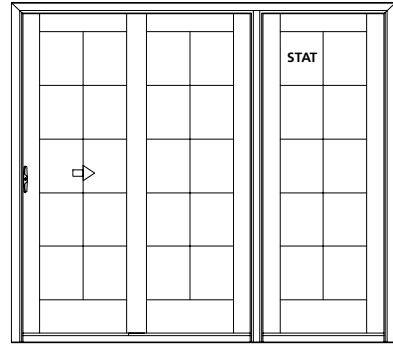

SPS4 76611

8'-0 3/4"  
8'-0"  
7'-11 1/2"  
81"

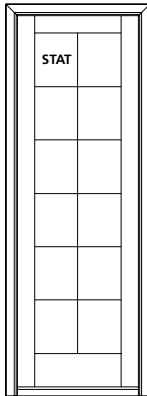

SPS4 2680

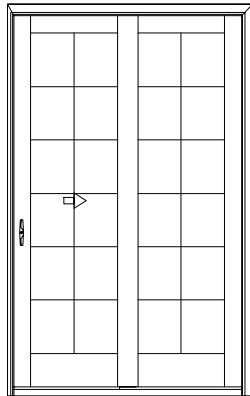

SPS4 5080

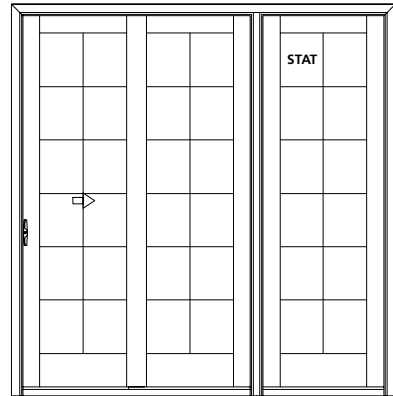

SPS4 7680

**Note:** See page NO TAG to specify handing.  
400 series doors are not field reversible.

SCALE 1/4" = 1'

**400 SERIES SLIDING PATIO DOORS**

**UNIT**  
**RSO**  
**FRAME**  
**GLASS**

3'-5 11/16"  
3'-4 3/16"  
3'-3 7/16"  
28 9/16"

6'-2 1/4"  
6'-0 3/4"  
6'-0"  
28 9/16"

9'-5 11/16"  
9'-4 3/16"  
9'-3 7/16"  
28 9/16"

6'-8 3/4"  
6'-8"  
6'-7 1/2"  
68"

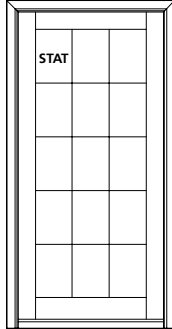

SPS4 3068

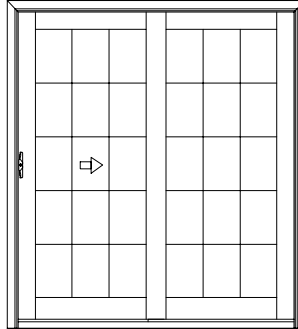

SPS4 6068

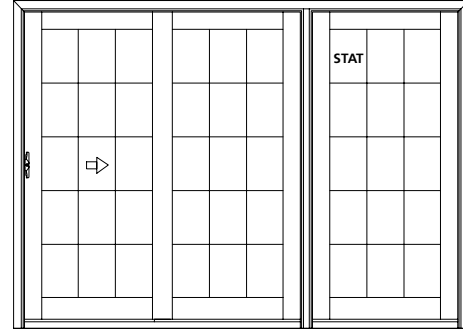

SPS4 9068

6'-11 3/4"  
6'-11"  
6'-10 1/2"  
68"

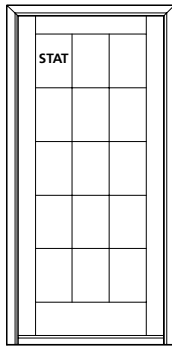

SPS4 30611

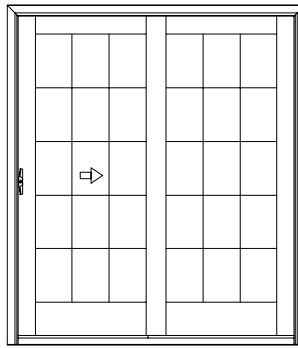

SPS4 60611

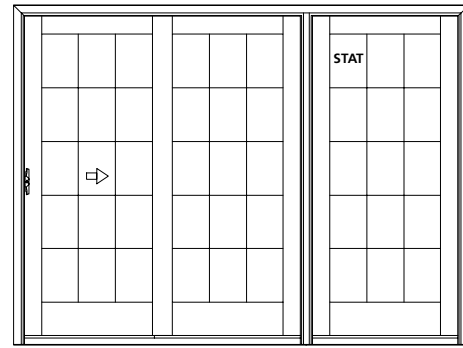

SPS4 90611

8'-0 3/4"  
8'-0"  
7'-11 1/2"  
81"

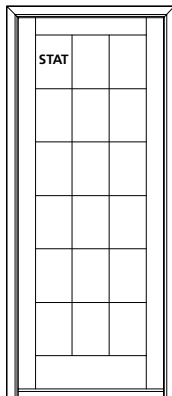

SPS4 3080

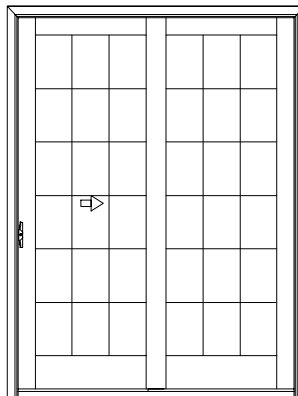

SPS4 6080

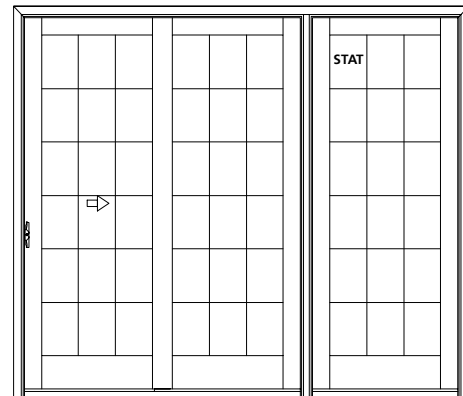

SPS4 9080

**Note:** See page NO TAG to specify handing.  
400 series doors are not field reversible.

SCALE 1/4" = 1'

**400 SERIES SLIDING PATIO DOORS**

<b>UNIT</b>	4'-5 11/16"	8'-2 1/4"	12'-5 11/16"
<b>RSO</b>	4'-4 3/16"	8'-0 3/4"	12'-4 3/16"
<b>FRAME</b>	4'-3 7/16"	8'-0"	12'-3 7/16"
<b>GLASS</b>	40 9/16"	40 9/16"	40 9/16"

6'-8 3/4"  
6'-8"  
6'-7 1/2"  
68"

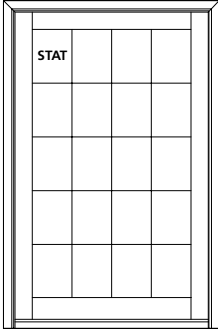

SPS4 4068

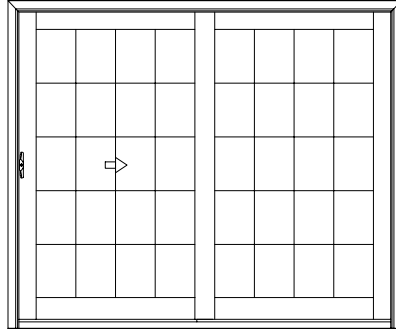

SPS4 8068

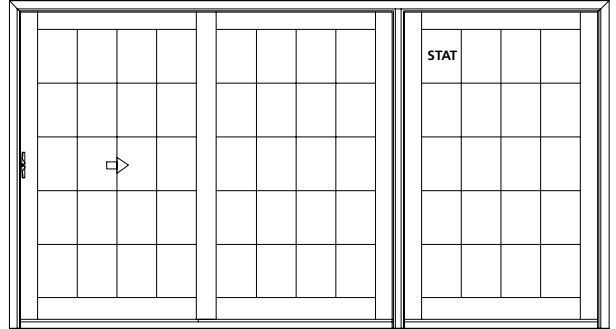

SPS4 12068

6'-11 3/4"  
6'-11"  
6'-10 1/2"  
68"

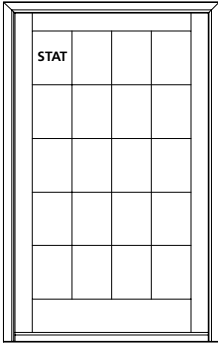

SPS4 40611

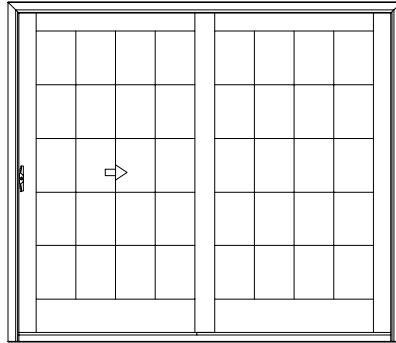

SPS4 80611

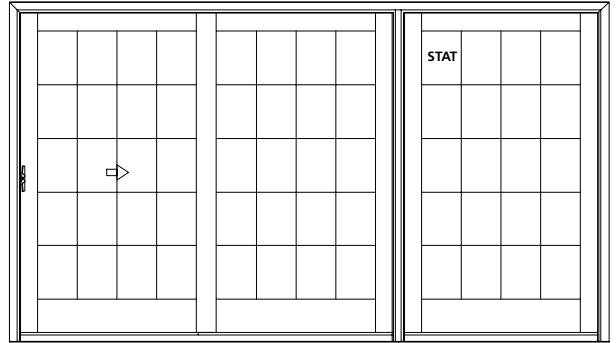

SPS4 120611

8'-0 3/4"  
8'-0"  
7'-11 1/2"  
81"

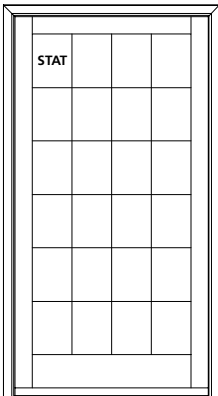

SPS4 4080

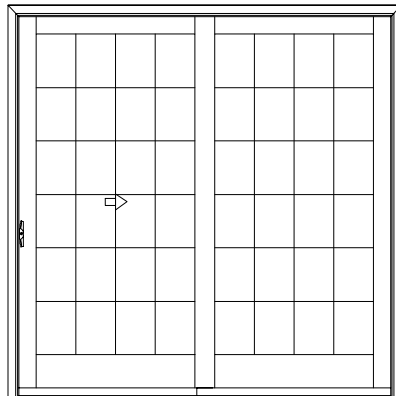

SPS4 8080

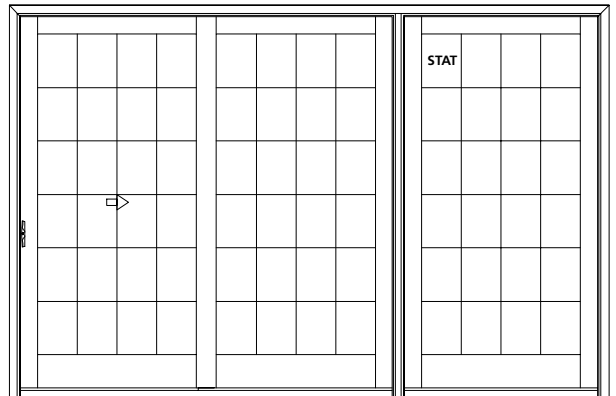

SPS4 12080

**Note:** See page NO TAG to specify handing.  
400 series doors are not field reversible.

SCALE 1/4" = 1'

**400 SERIES 4-PANEL SLIDING PATIO DOORS**

**UNIT**  
**R50**  
**FRAME**  
**GLASS**

10'-0 1/4"  
9'-10 3/4"  
9'-10"  
22 9/16"

12'-0 1/4"  
11'-10 3/4"  
11'-10"  
28 9/16"

6'-8 3/4"  
6'-8"  
6'-7 1/2"  
68"

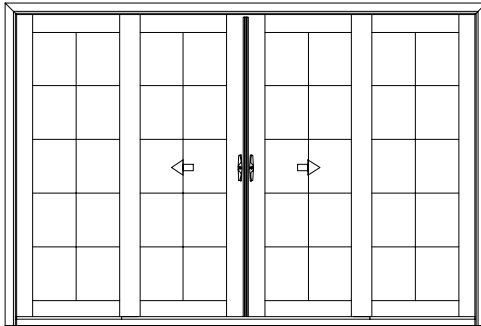

SPS4 100Q68

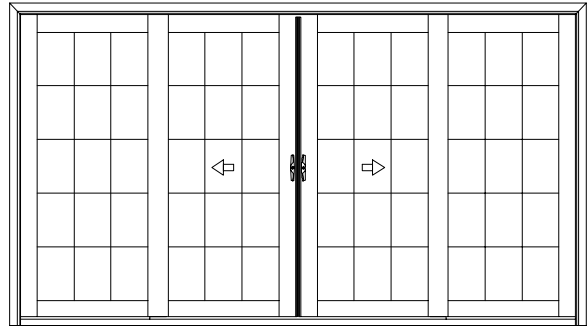

SPS4 120Q68

6'-11 3/4"  
6'-11"  
6'-10 1/2"  
68"

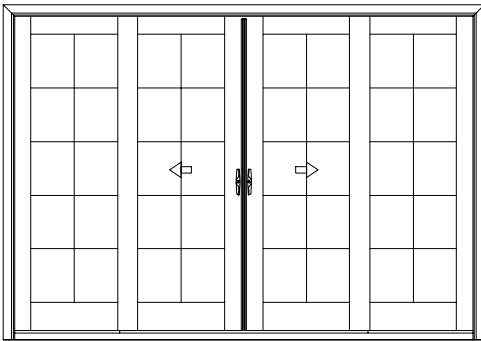

SPS4 100Q611

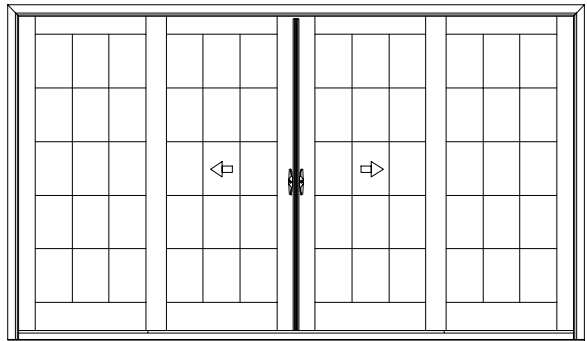

SPS4 120Q611

8'-0 3/4"  
8'-0"  
7'-11 1/2"  
81"

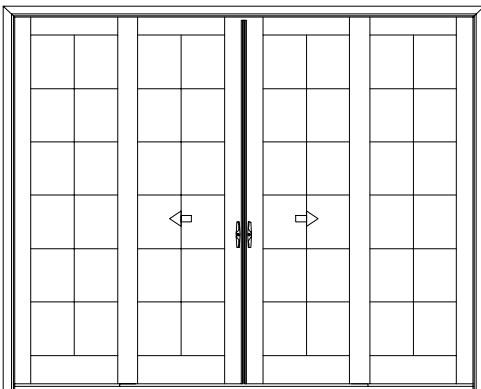

SPS4 100Q80

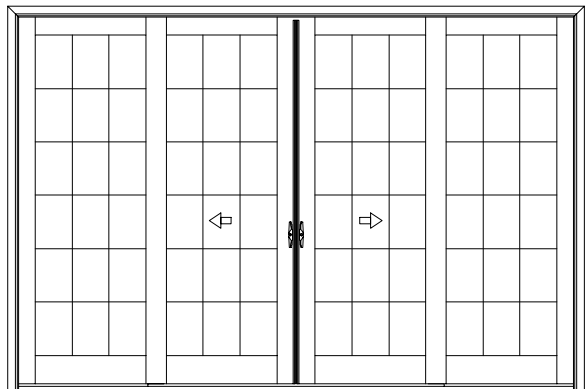

SPS4 120Q80

**Note:** See page NO TAG to specify handing.  
4-Panel doors are not field reversible.

SCALE 1/4" = 1'



**400 SERIES 4-PANEL SLIDING PATIO DOORS**

**UNIT**  
**RSO**  
**FRAME**  
**GLASS**

16'-0 1/4"  
15'-10 3/4"  
15'-10"  
40 9/16"

6'-8 3/4"  
6'-8"  
6'-7 1/2"  
68"

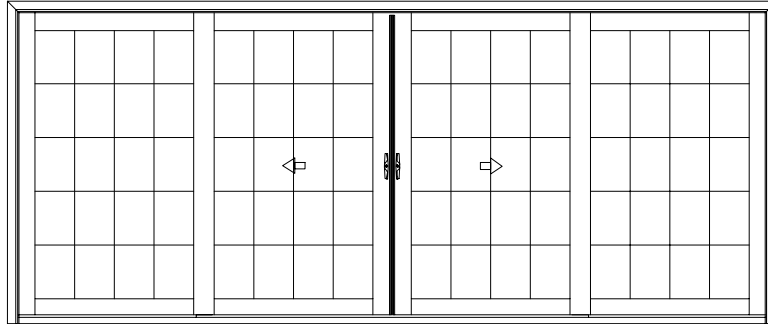

SPS4 160Q68

6'-11 3/4"  
6'-11"  
6'-10 1/2"  
68"

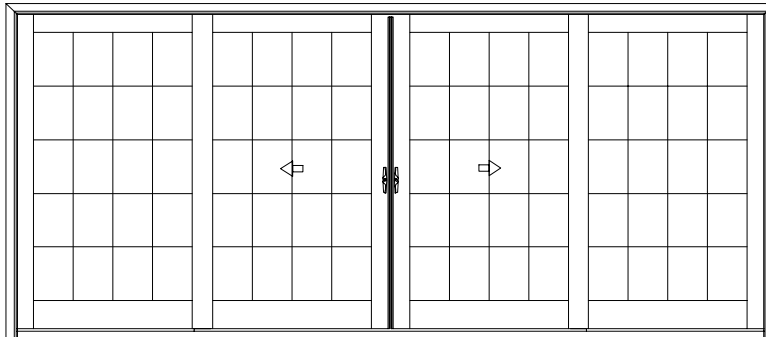

SPS4 160Q611

8'-0 3/4"  
8'-0"  
7'-11 1/2"  
81"

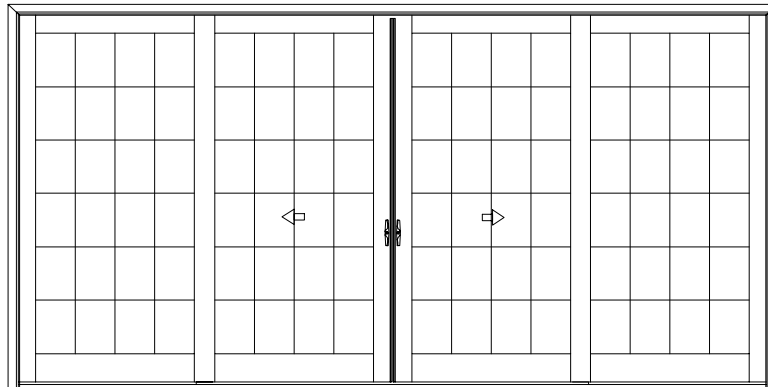

SPS4 160Q80

**Note:** See page NO TAG to specify handing.  
4-Panel doors are not field reversible.

SCALE 1/4" = 1'

**400 SERIES TRANSOM ALIGNMENT GUIDE**

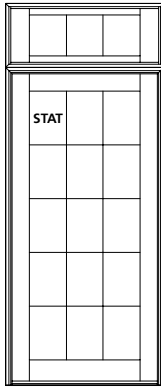

ONE PANEL TRANSOM

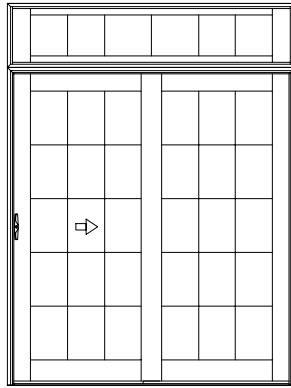

ONE PANEL TRANSOM

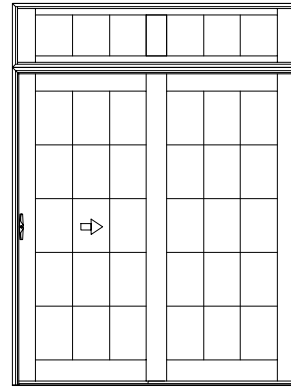

ONE PANEL (2-LITE) TRANSOM

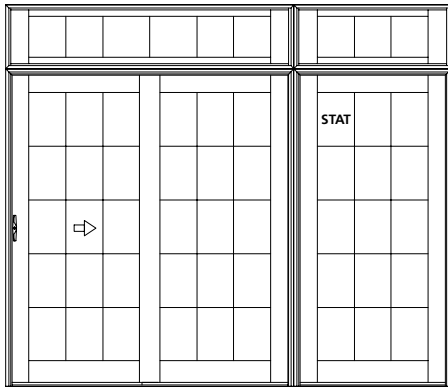

ONE PANEL TRANSOM

ONE PANEL TRANSOM

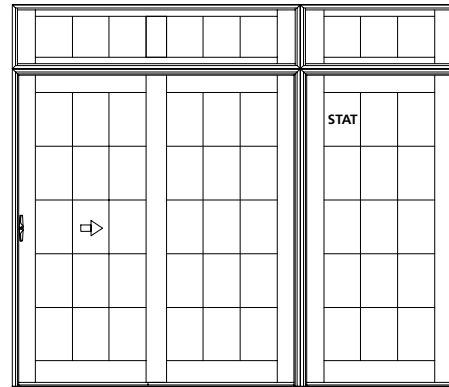

ONE PANEL (2-LITE) TRANSOM

ONE PANEL TRANSOM

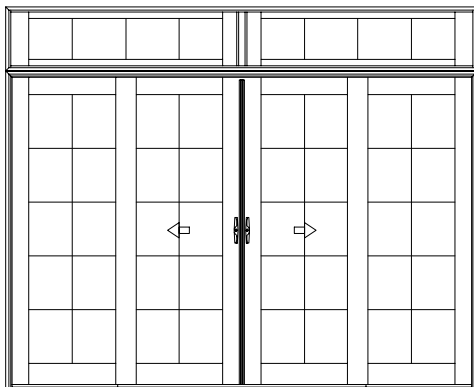

QUAD 2-PANEL TRANSOM  
AVAILABLE ON 10-0 & 12-0 WIDTHS ONLY

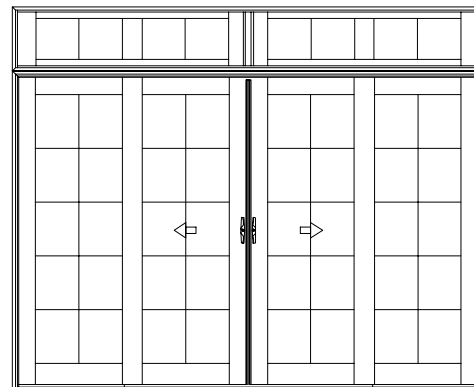

QUAD 2-PANEL (4-LITE) TRANSOM  
(WILL ALIGN WITH INTERLOCKS ON QUAD DOOR)  
AVAILABLE ON 10-0 & 12-0 WIDTHS ONLY

SCALE 1/4" = 1'

**400 SERIES SLIDING DOOR TRANSOMS**

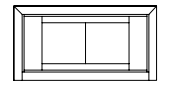

**ONE PANEL TRANSOM**

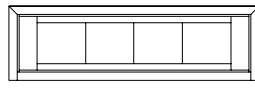

**ONE PANEL TRANSOM**

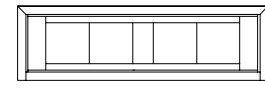

**ONE PANEL (2-LITE) TRANSOM\***

**UNIT** 2'-11 11/16"  
**RSO** 2'-10 3/16"  
**FRAME** 2'-9 7/16"  
**GLASS** 22 9/16"

5'-2 1/4"  
5'-0 3/4"  
5'-0"  
49 5/16"

5'-2 1/4"  
5'-0 3/4"  
5'-0"  
22 9/16"

1'-6 1/16"  
1'-4 1/2"  
1'-4"  
11 1/16"

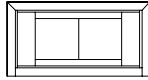

SPS4 2614-1



SPS4 5014-1

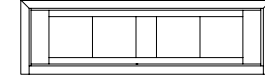

SPS4 5014-2

1'-8 1/16"  
1'-6 1/2"  
1'-6"  
13 1/16"

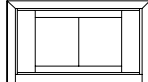

SPS4 2616-1

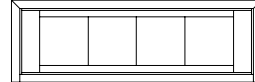

SPS4 5016-1

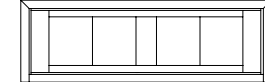

SPS4 5016-2

2'-2 1/16"  
2'-0 1/2"  
2'-0"  
19 1/16"

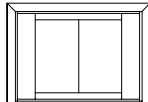

SPS4 2620-1



SPS4 5020-1

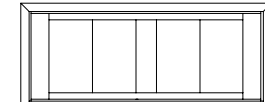

SPS4 5020-2

**UNIT** 3'-5 11/16"  
**RSO** 3'-4 3/16"  
**FRAME** 3'-3 7/16"  
**GLASS** 28 9/16"

6'-2 1/4"  
6'-0 3/4"  
6'-0"  
61 5/16"

6'-2 1/4"  
6'-0 3/4"  
6'-0"  
28 9/16"

1'-6 1/16"  
1'-4 1/2"  
1'-4"  
11 1/16"

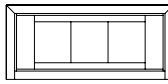

SPS4 3014-1

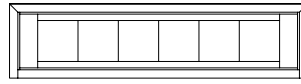

SPS4 6014-1

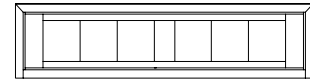

SPS4 6014-2

1'-8 1/16"  
1'-6 1/2"  
1'-6"  
13 1/16"

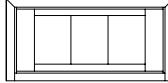

SPS4 3016-1

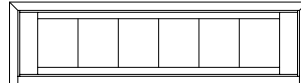

SPS4 6016-1

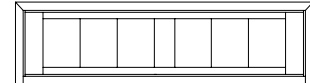

SPS4 6016-2

2'-2 1/16"  
2'-0 1/2"  
2'-0"  
19 1/16"

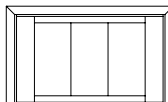

SPS4 3020-1

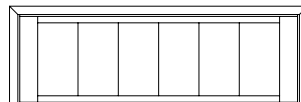

SPS4 6020-1



SPS4 6020-2

**UNIT** 4'-5 11/16"  
**RSO** 4'-4 3/16"  
**FRAME** 4'-3 7/16"  
**GLASS** 40 9/16"

8'-2 1/4"  
8'-0 3/4"  
8'-0"  
85 5/16"

8'-2 1/4"  
8'-0 3/4"  
8'-0"  
40 9/16"

1'-6 1/16"  
1'-4 1/2"  
1'-4"  
11 1/16"



SPS4 4016-1



SPS4 8014-1



SPS4 8014-2

1'-8 1/16"  
1'-6 1/2"  
1'-6"  
13 1/16"

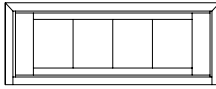

SPS4 4016-1

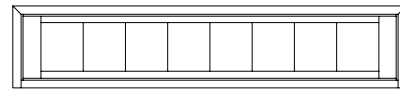

SPS4 8016-1

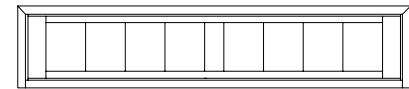

SPS4 8016-2

2'-2 1/16"  
2'-0 1/2"  
2'-0"  
19 1/16"

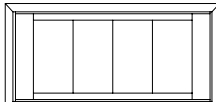

SPS4 4020-1

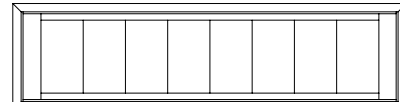

SPS4 8020-1

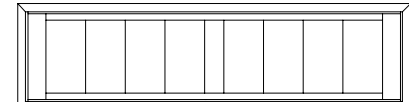

SPS4 8020-2

\*Note: See Horizontal Section on page 16-62 for post detail.

SCALE 1/4" = 1'

**400 SERIES 4-PANEL SLIDING DOOR TRANSOMS**

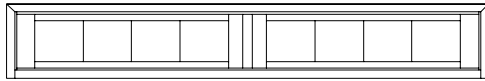

**ONE PANEL (2-LITE) TRANSOM**

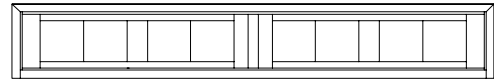

**2 PANEL (4-LITE) TRANSOM\***  
(WILL LINE UP WITH INTERLOCKS ON QUAD DOOR)

**UNIT** 10'-0 1/4"  
**RSO** 9'-10 3/4"  
**FRAME** 9'-10"  
**GLASS** 49 5/16"

10'-0 1/4"  
9'-10 3/4"  
9'-10"  
22 9/16"

1'-6 1/16"  
1'-4 1/2"  
1'-4"  
11 1/16"

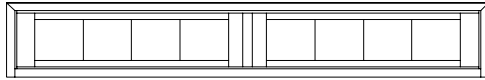

SPS4 10014-2

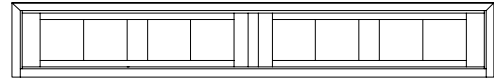

SPS4 10014-4

1'-8 1/16"  
1'-6 1/2"  
1'-6"  
13 1/16"

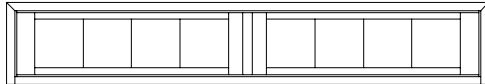

SPS4 10016-2

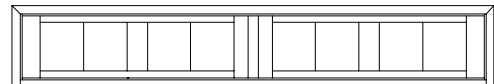

SPS4 10016-4

2'-2 1/16"  
2'-0 1/2"  
2'-0"  
19 1/16"

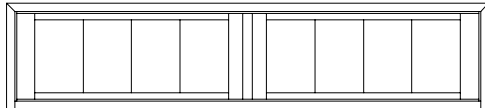

SPS4 10020-2

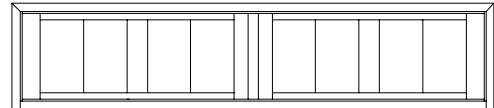

SPS4 10020-4

**UNIT** 12'-0 1/4"  
**RSO** 11'-10 3/4"  
**FRAME** 11'-10"  
**GLASS** 61 5/16"

12'-0 1/4"  
11'-10 3/4"  
11'-10"  
28 9/16"

1'-6 1/16"  
1'-4 1/2"  
1'-4"  
11 1/16"

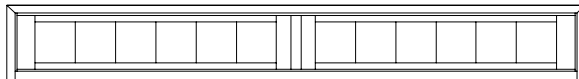

SPS4 12014-2

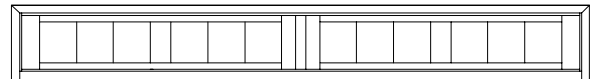

SPS4 12014-4

1'-8 1/16"  
1'-6 1/2"  
1'-6"  
13 1/16"

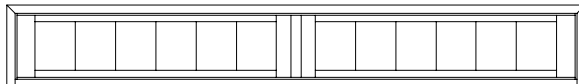

SPS4 12016-2

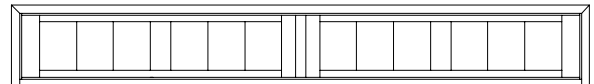

SPS4 12016-4

2'-2 1/16"  
2'-0 1/2"  
2'-0"  
19 1/16"

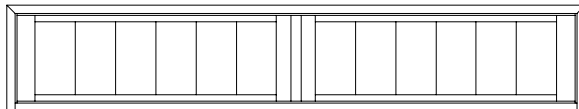

SPS4 12020-2

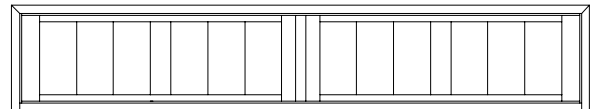

SPS4 12020-4

\*Note: See Horizontal Section on page 16-62 for post detail.

SCALE 1/4" = 1'

**PANEL GLAZING OPTIONS**

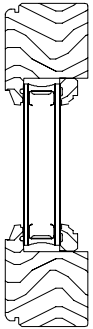

**3/4" INSULATED**

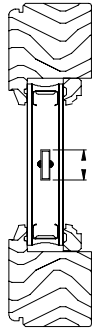

**3/4" INSULATED  
WITH 5/8"  
AIRSPACE GRILLE**

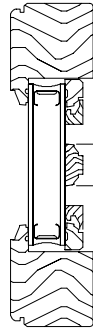

**3/4" INSULATED  
WITH 7/8"  
FULL SURROUND  
WOOD GRILLE**

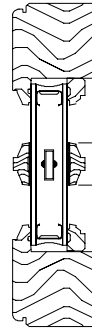

**3/4" INSULATED  
WITH 7/8" SDL  
WITH SHADOW BAR**

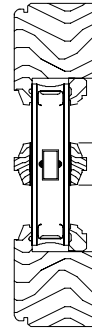

**3/4" INSULATED  
WITH 7/8" SDL  
WITH SILVER SPACER**

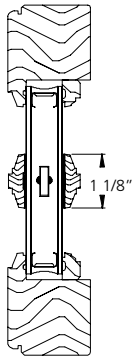

**3/4" INSULATED  
WITH 1 1/8" SDL  
WITH SHADOW BAR**

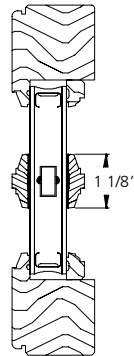

**3/4" INSULATED  
WITH 1 1/8" SDL  
WITH SILVER SPACER**

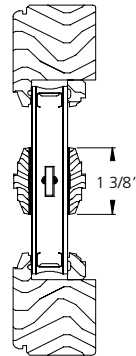

**3/4" INSULATED  
WITH 1 3/8" SDL  
WITH SHADOW BAR**

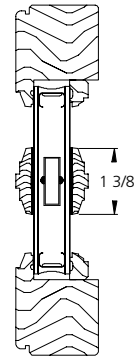

**3/4" INSULATED  
WITH 1 3/8" SDL  
WITH SILVER SPACER**

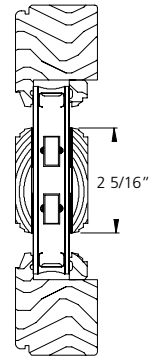

**3/4" INSULATED  
WITH 2 5/16"  
SIMULATED  
CHECK RAIL WITH  
SILVER SPACER BARS  
(SHADOW BARS  
ALSO AVAILABLE)**

**NOTE:** SDL not available on textured glass.

SCALE 3" = 1'

**TRIM OPTIONS**

**EXTERIOR TRIM**

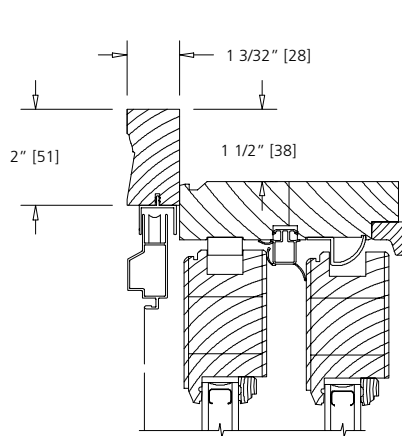

**BRICKMOULD**

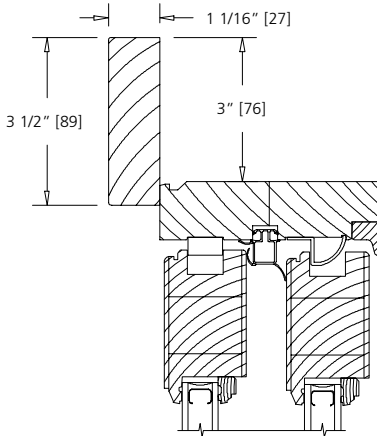

**FLAT CASING**

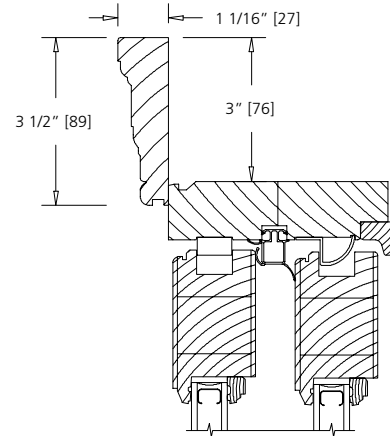

**ADAMS CASING**

**WOOD SUBSILL OPTIONS**

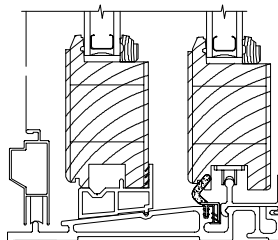

**STANDARD**

**LITE CUT INFORMATION**

Wood Sliding patio doors are available in 7/8", 1-1/8" and 1-3/8" widths for SDL (Simulated Divided Lites), 5/8", 23/32" and 1" GBG (Grilles between the Glass) and 7/8" removable grilles. Standard lite cuts are rectangular.

**LITE CUT OPTIONS**

Special lite cut patterns can include a wide variety of straight line and radius patterns. The illustrations shown here represent just a few of the possibilities. Rectangular, horizontal, vertical and Prairie lite patterns are available in all standard size Wood Sliding patio doors. Uneven, diamond, radius and Gothic lite cuts are available, subject to approval. Approvals are based on the ability to fulfill the design requirement while maintaining the construction integrity of the finished product.

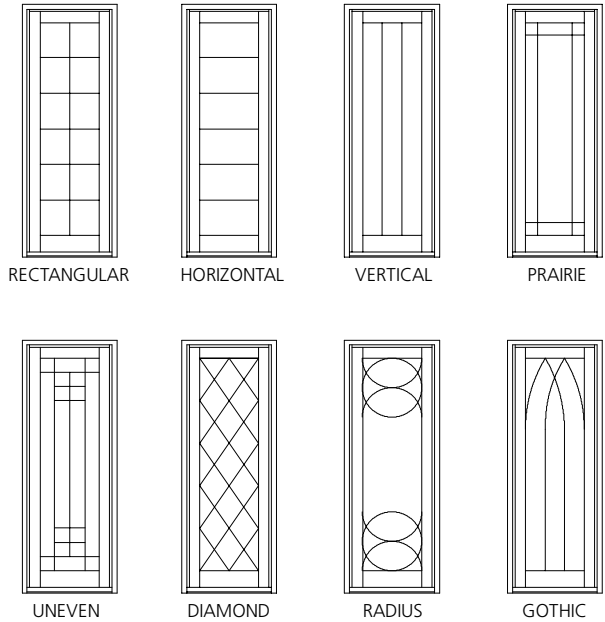

**BAR ALIGNMENT**

Alignment of divided lite muntin bars from one product to the next is often required by fine architectural design. Wood grilles, GBG's, and Simulated Divided Lites may be specified with muntin bars aligned.

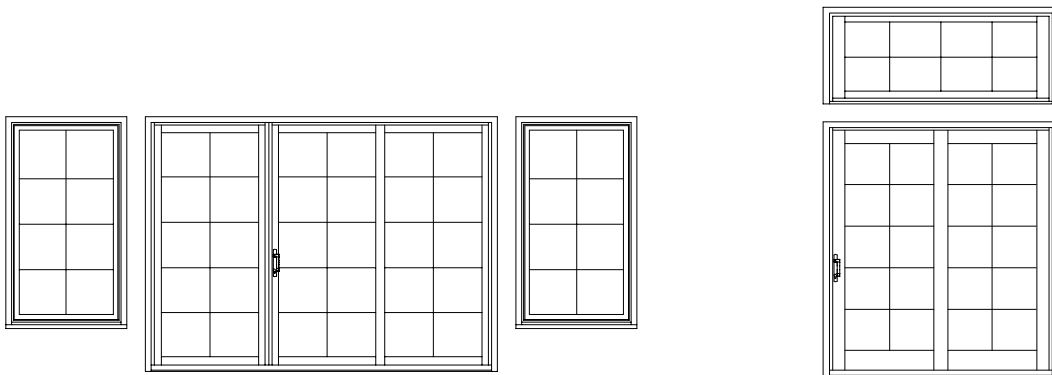

**GRILLES & SDL LITE PATTERNS**

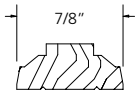

**7/8" WOOD GRILLE  
FOR FULL SURROUND**

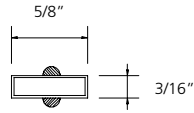

**5/8" AIRSPACE GRILLE**

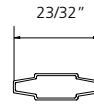

**CONTOUR AIRSPACE GRILLE**

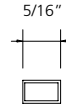

**5/16" AIRSPACE GRILLE <sup>1</sup>  
(BRASS ONLY)**

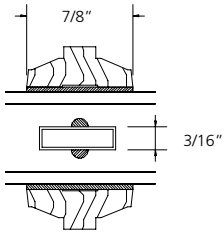

**7/8" SDL  
WITH SHADOW BAR**

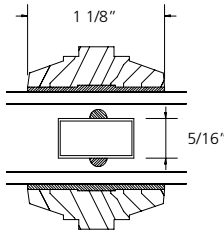

**1 1/8" SDL  
WITH SILVER SPACER**

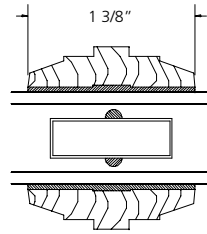

**1 3/8" SDL  
WITH SILVER SPACER**

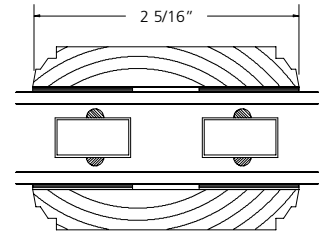

**2 5/16" SIMULATED CHECK RAIL <sup>1</sup>  
WITH SILVER SPACER BARS**

**EXAMPLES OF POSSIBLE LITE PATTERNS <sup>2</sup>**

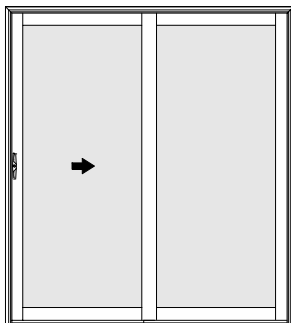

**ONE-LITE  
(NO GRILLE OR SDL)**

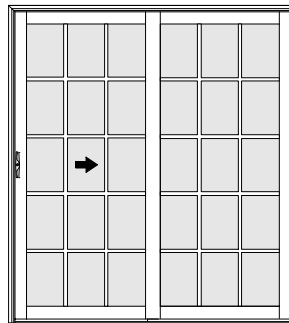

**15-LITE  
3W5H STANDARD CUT <sup>3</sup>**

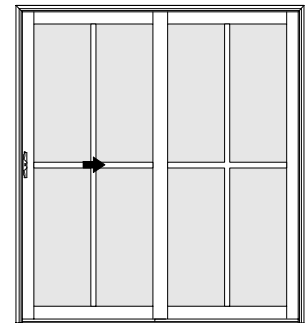

**4-LITE  
2W2H CUSTOM CUT**

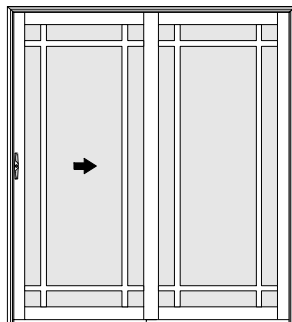

**9-LITE  
3W3H MARGINAL (PRAIRIE)  
LITE CUT  
1 3/8" SDL W/4"  
DAYLIGHT CORNERS**

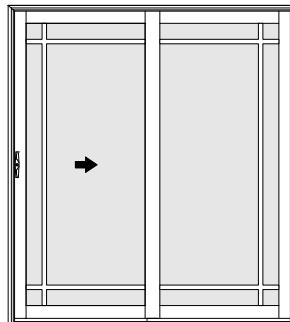

**6-LITE  
2W3H CUSTOM CUT  
LITE CUT  
1 1/8" SDL W/4"  
DAYLIGHT CORNERS**

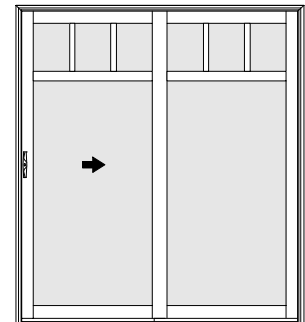

**4-LITE  
2 5/16" HORIZONTAL SDL  
WITH 3W1H  
1 3/8" SDL  
IN TOP OF PANEL**

<sup>1</sup> Not available in Radius Lite Patterns.

<sup>2</sup> Other Lite Patterns Available.

<sup>3</sup> See Door Elevations for Standard Lite Patterns.

EXAMPLES NOT TO SCALE



**GRILLES & SDL LITE PATTERNS**

**PRIMED SLIDING PATIO DOORS - Standard Lite Patterns**

Applies to all Wood Grilles, Airspace Grilles, and SDL (Simulated Divided Lite)

**300 SERIES**

6-8 HEIGHT		6-11 HEIGHT		8-0 HEIGHT	
UNIT SIZE	STANDARD LITE PATTERN	UNIT SIZE	STANDARD LITE PATTERN	UNIT SIZE	STANDARD LITE PATTERN
SPS3 2-6	2W x 5H	SPS3 2-6	2W x 5H	SPS3 2-6	2W x 6H
SPS3 5-0	2W x 5H	SPS3 5-0	2W x 5H	SPS3 5-0	2W x 6H
SPS3 7-6	2W x 5H	SPS3 7-6	2W x 5H	SPS3 7-6	2W x 6H
SPS3 3-0	3W x 5H	SPS3 3-0	3W x 5H	SPS3 3-0	3W x 6H
SPS3 6-0	3W x 5H	SPS3 6-0	3W x 5H	SPS3 6-0	3W x 6H
SPS3 9-0	3W x 5H	SPS3 9-0	3W x 5H	SPS3 9-0	3W x 6H
SPS3 4-0	4W x 5H	SPS3 4-0	4W x 5H	SPS3 4-0	4W x 6H
SPS3 8-0	4W x 5H	SPS3 8-0	4W x 5H	SPS3 8-0	4W x 6H
SPS3 12-0	4W x 5H	SPS3 12-0	4W x 5H	SPS3 12-0	4W x 6H
SPS3 10-0Q	2W x 5H	SPS3 10-0Q	2W x 5H	SPS3 10-0Q	2W x 6H
SPS3 12-0Q	3W x 5H	SPS3 12-0Q	3W x 5H	SPS3 12-0Q	3W x 6H
SPS3 16-0Q	4W x 5H	SPS3 16-0Q	4W x 5H	SPS3 16-0Q	4W x 6H

CUSTOM LITE PATTERNS ARE AVAILABLE

**400 SERIES**

6-8 HEIGHT		6-11 HEIGHT		8-0 HEIGHT	
UNIT SIZE	STANDARD LITE PATTERN	UNIT SIZE	STANDARD LITE PATTERN	UNIT SIZE	STANDARD LITE PATTERN
SPS4 2-6	2W x 5H	SPS4 2-6	2W x 5H	SPS4 2-6	2W x 6H
SPS4 5-0	2W x 5H	SPS4 5-0	2W x 5H	SPS4 5-0	2W x 6H
SPS4 7-6	2W x 5H	SPS4 7-6	2W x 5H	SPS4 7-6	2W x 6H
SPS4 3-0	3W x 5H	SPS4 3-0	3W x 5H	SPS4 3-0	3W x 6H
SPS4 6-0	3W x 5H	SPS4 6-0	3W x 5H	SPS4 6-0	3W x 6H
SPS4 9-0	3W x 5H	SPS4 9-0	3W x 5H	SPS4 9-0	3W x 6H
SPS4 4-0	4W x 5H	SPS4 4-0	4W x 5H	SPS4 4-0	4W x 6H
SPS4 8-0	4W x 5H	SPS4 8-0	4W x 5H	SPS4 8-0	4W x 6H
SPS4 12-0	4W x 5H	SPS4 12-0	4W x 5H	SPS4 12-0	4W x 6H
SPS4 10-0Q	2W x 5H	SPS4 10-0Q	2W x 5H	SPS4 10-0Q	2W x 6H
SPS4 12-0Q	3W x 5H	SPS4 12-0Q	3W x 5H	SPS4 12-0Q	3W x 6H
SPS4 16-0Q	4W x 5H	SPS4 16-0Q	4W x 5H	SPS4 16-0Q	4W x 6H

CUSTOM LITE PATTERNS ARE AVAILABLE

**NOTE:** LISTED LITE PATTERNS ARE PER DOOR PANEL

**CLEAR OPENING LAYOUT**  
**NARROW STYLE**

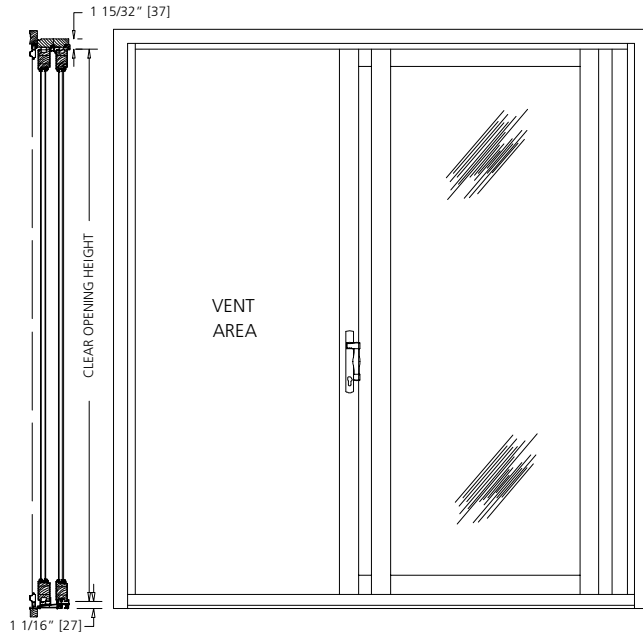

**HORIZONTAL**  
Two Panel Assembly

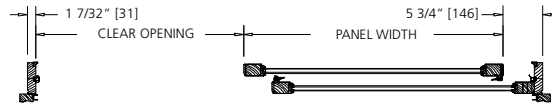

**CLEAR OPENING FORMULA:**

**VERTICAL**  
Frame - 4 1/16" = Clear Opening

**HORIZONTAL**  
Frame - (Panel Width + 7 1/2") = Clear Opening

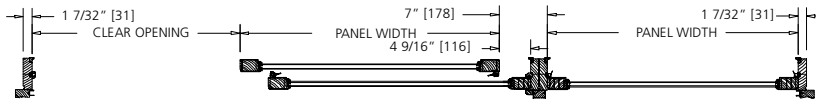

**HORIZONTAL**  
Three Panel End Operator

**CLEAR OPENING FORMULA:**

**VERTICAL**  
Frame - 4 1/16" = Clear Opening

**HORIZONTAL**  
Frame - ((2 x Panel Width) + 8 11/16") = Clear Opening

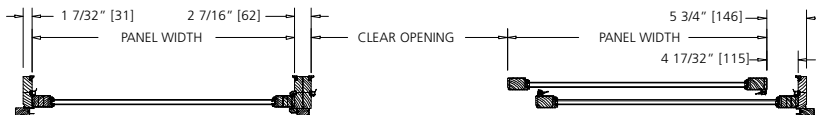

**HORIZONTAL**  
Three Panel Center Operator

**CLEAR OPENING FORMULA:**

**VERTICAL**  
Frame - 4 1/16" = Clear Opening

**HORIZONTAL**  
Frame - ((2 x Panel Width) + 8 11/16") = Clear Opening

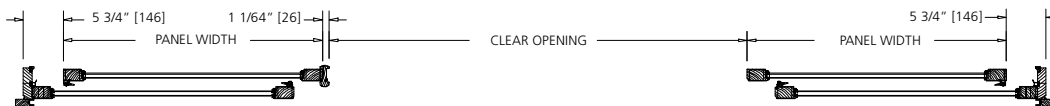

**HORIZONTAL**  
Four Panel Assembly

**CLEAR OPENING FORMULA:**

**VERTICAL**  
Frame - 4 1/16" = Clear Opening

**HORIZONTAL**  
Frame - ((2 x (Panel Width + 5 3/4")) + 1 3/4") = Clear Opening

**CLEAR OPENING LAYOUT  
WIDE STYLE**

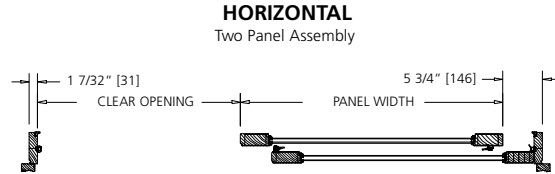
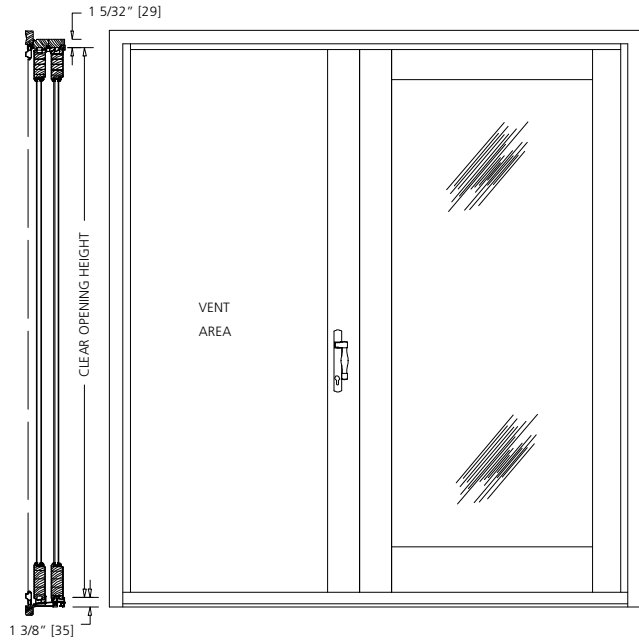

**HORIZONTAL**  
Two Panel Assembly

**CLEAR OPENING FORMULA:**

**VERTICAL**  
Frame - 4 1/16" = Clear Opening

**HORIZONTAL**  
Frame - (Panel Width + 7 1/2") = Clear Opening

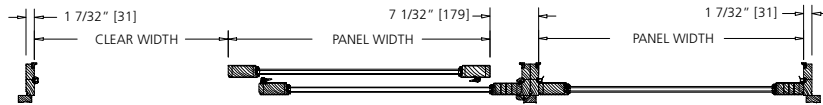

**HORIZONTAL**  
Three Panel End Operator

**CLEAR OPENING FORMULA:**

**VERTICAL**  
Frame - 4 1/16" = Clear Opening

**HORIZONTAL**  
Frame - ((2 x Panel Width) + 8 11/16") = Clear Opening

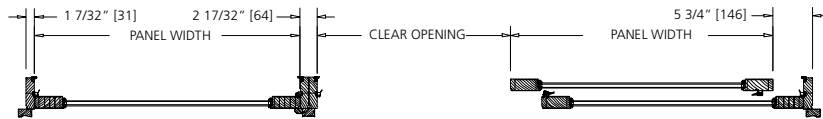

**HORIZONTAL**  
Three Panel Center Operator

**CLEAR OPENING FORMULA:**

**VERTICAL**  
Frame - 4 1/16" = Clear Opening

**HORIZONTAL**  
Frame - ((2 x Panel Width) + 8 11/16") = Clear Opening



**HORIZONTAL**  
Four Panel Assembly

**CLEAR OPENING FORMULA:**

**VERTICAL**  
Frame - 4 1/16" = Clear Opening

**HORIZONTAL**  
Frame - ((2 x (Panel Width + 5 3/4")) + 1 3/4") = Clear Opening

**CLEAR OPENING SPECIFICATIONS**

**300 SERIES**

Unit No.	Sq. Ft. Vent & Clear Opening	Clear Opening		Sq. Ft. Daylight Opening	Sq. Ft. Unit
		Width (in.)	Height (in.)		
SPS3 2-6x6-8	S.S.	S.S.	S.S.	11.65	18.08
SPS3 3-0x6-8	S.S.	S.S.	S.S.	14.59	21.39
SPS3 4-0x6-8	S.S.	S.S.	S.S.	20.47	28.02
SPS3 5-0x6-8	12.52	23 9/16	76 1/2	23.30	33.03
SPS3 6-0x6-8	15.70	29 9/16	76 1/2	29.18	39.75
SPS3 8-0x6-8	22.08	41 9/16	76 1/2	40.94	53.00
SPS3 10-0Qx6-8	25.04	47 1/8	76 1/2	46.60	66.06
SPS3 12-0Qx6-8	31.40	59 1/8	76 1/2	58.36	79.50
SPS3 16-0Qx6-8	44.16	83 1/8	76 1/2	81.88	106.00
SPS3 2-6x6-11	S.S.	S.S.	S.S.	12.14	18.76
SPS3 3-0x6-11	S.S.	S.S.	S.S.	15.21	22.20
SPS3 4-0x6-11	S.S.	S.S.	S.S.	21.34	29.08
SPS3 5-0x6-11	13.01	23 9/16	79 1/2	24.28	34.38
SPS3 6-0x6-11	16.32	29 9/16	79 1/2	30.42	41.25
SPS3 8-0x6-11	22.95	41 9/16	79 1/2	42.68	55.00
SPS3 10-0Qx6-11	26.02	47 1/8	79 1/2	48.56	68.76
SPS3 12-0Qx6-11	32.64	59 1/8	79 1/2	60.84	82.50
SPS3 16-0Qx6-11	45.90	83 1/8	79 1/2	85.36	110.00
SPS3 2-6x8-0	S.S.	S.S.	S.S.	14.28	21.72
SPS3 3-0x8-0	S.S.	S.S.	S.S.	17.90	25.70
SPS3 4-0x8-0	S.S.	S.S.	S.S.	25.11	33.66
SPS3 5-0x8-0	15.13	23 9/16	92 1/2	28.56	39.79
SPS3 6-0x8-0	18.99	29 9/16	92 1/2	35.80	47.75
SPS3 8-0x8-0	26.70	41 9/16	92 1/2	50.22	63.67
SPS3 10-0Qx8-0	30.26	47 1/8	92 1/2	57.12	79.58
SPS3 12-0Qx8-0	37.98	59 1/8	92 1/2	71.60	95.50
SPS3 16-0Qx8-0	53.40	83 1/8	92 1/2	100.44	127.34

**400 SERIES**

Unit No.	Sq. Ft. Vent & Clear Opening	Clear Opening		Sq. Ft. Daylight Opening	Sq. Ft. Unit
		Width (in.)	Height (in.)		
SPS4 2-6x6-8	S.S.	S.S.	S.S.	10.11	18.46
SPS4 3-0x6-8	S.S.	S.S.	S.S.	12.90	21.77
SPS4 4-0x6-8	S.S.	S.S.	S.S.	18.50	28.40
SPS4 5-0x6-8	12.15	22 7/8	76 1/2	20.22	33.03
SPS4 6-0x6-8	15.34	28 7/8	76 1/2	25.80	39.75
SPS4 8-0x6-8	21.71	40 7/8	76 1/2	37.00	53.00
SPS4 10-0Qx6-8	24.30	45 3/4	76 1/2	40.44	66.06
SPS4 12-0Qx6-8	30.68	57 3/4	76 1/2	51.60	79.50
SPS4 16-0Qx6-8	43.42	81 3/4	76 1/2	74.00	106.00
SPS4 2-6x6-11	S.S.	S.S.	S.S.	10.11	19.16
SPS4 3-0x6-11	S.S.	S.S.	S.S.	12.90	22.60
SPS4 4-0x6-11	S.S.	S.S.	S.S.	18.50	29.47
SPS4 5-0x6-11	12.63	22 7/8	79 1/2	20.22	34.38
SPS4 6-0x6-11	15.94	28 7/8	79 1/2	25.80	41.25
SPS4 8-0x6-11	22.57	40 7/8	79 1/2	37.00	55.00
SPS4 10-0Qx6-11	25.26	45 3/4	79 1/2	40.44	68.76
SPS4 12-0Qx6-11	31.88	57 3/4	79 1/2	51.60	82.50
SPS4 16-0Qx6-11	45.14	81 3/4	79 1/2	74.00	110.00
SPS4 2-6x8-0	S.S.	S.S.	S.S.	12.06	22.18
SPS4 3-0x8-0	S.S.	S.S.	S.S.	15.40	26.16
SPS4 4-0x8-0	S.S.	S.S.	S.S.	22.08	34.09
SPS4 5-0x8-0	14.69	22 7/8	92 1/2	24.12	39.79
SPS4 6-0x8-0	18.55	28 7/8	92 1/2	30.80	47.75
SPS4 8-0x8-0	26.26	40 7/8	92 1/2	44.16	63.67
SPS4 10-0Qx8-0	29.38	45 3/4	92 1/2	48.24	79.58
SPS4 12-0Qx8-0	37.10	57 3/4	92 1/2	61.60	95.50
SPS4 16-0Qx8-0	52.52	81 3/4	92 1/2	88.32	127.34

**Note:** S.S denotes Stationary Sidelite.

**UNIT SIZING, ROUGH OPENINGS  
& MASONRY OPENINGS**

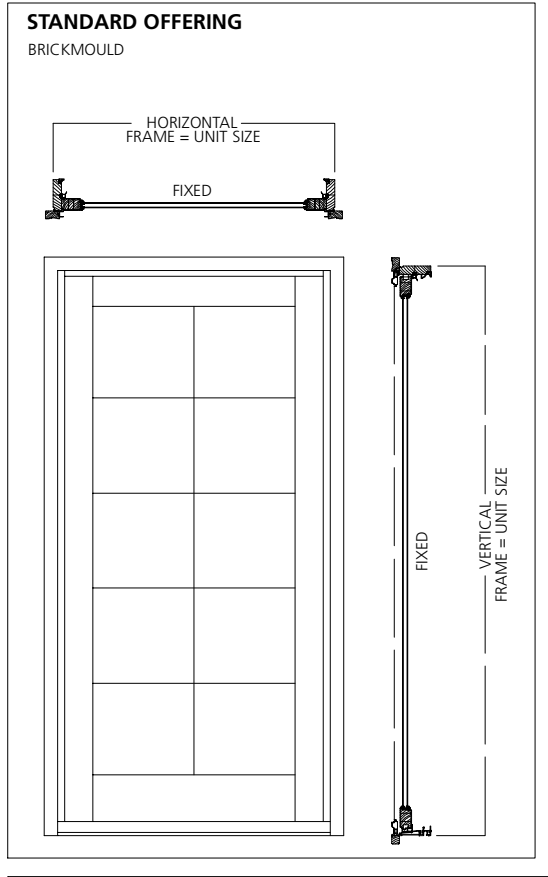

**GENERAL NOTES:**

UNITS WITH NO EXTERIOR TRIM  
FRAME SIZE = UNIT SIZE

UNIT SIZE IS ALWAYS THE  
EXTREME SIZE OF THE DOOR  
WITH OR WITHOUT TRIM

ROUGH OPENING IS ALWAYS 3/4" OVER  
FRAME SIZE OF THE DOOR

MASONRY OPENING IS ALWAYS 1/2"  
OVER THE UNIT SIZE OF THE DOOR

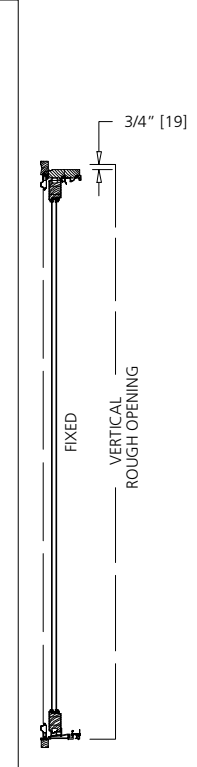
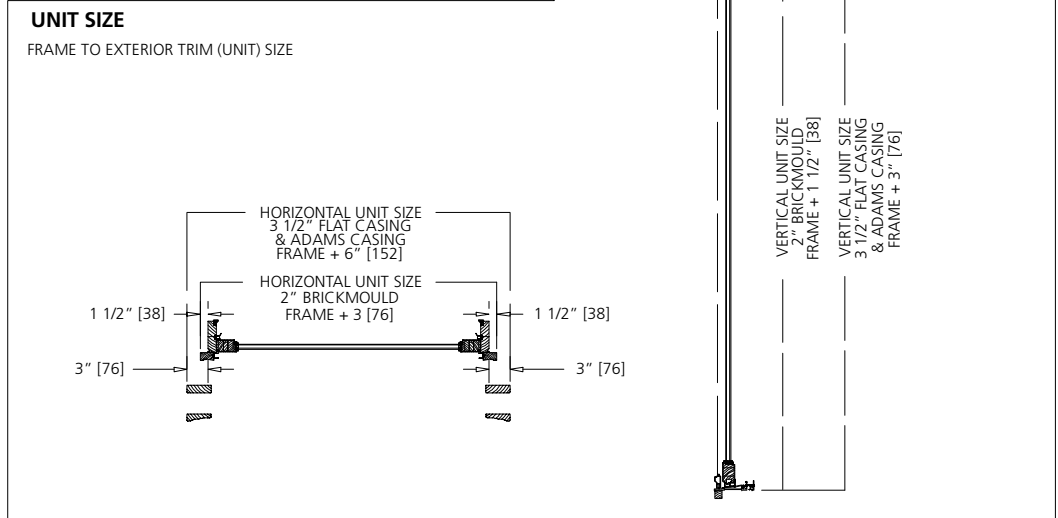
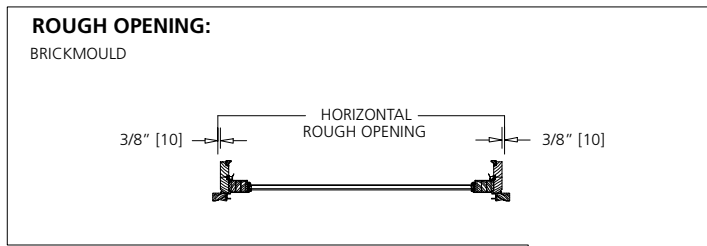

300 SERIES SLIDING PATIO DOORS

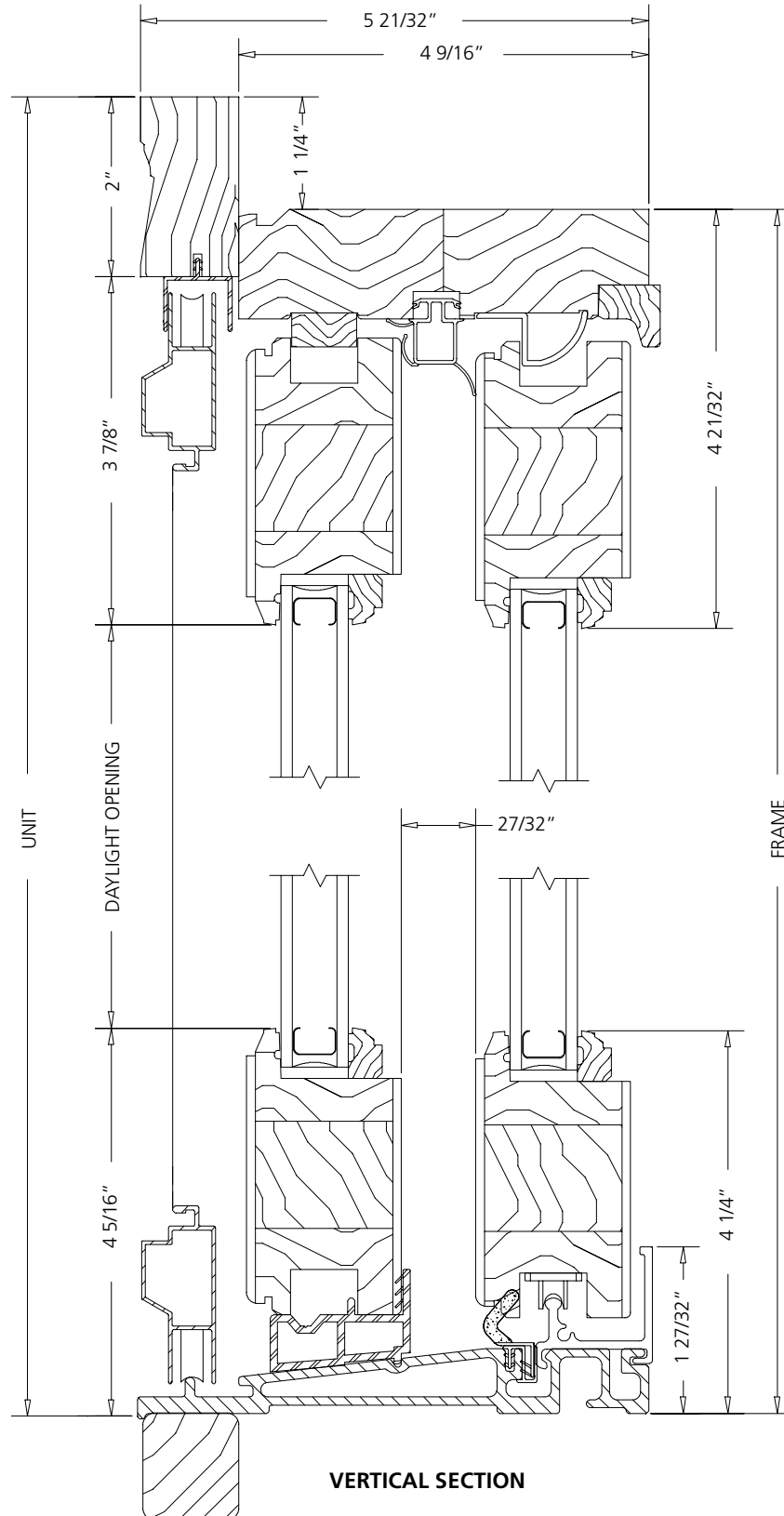

SCALE: 6" = 1'

300 SERIES SLIDING PATIO DOORS

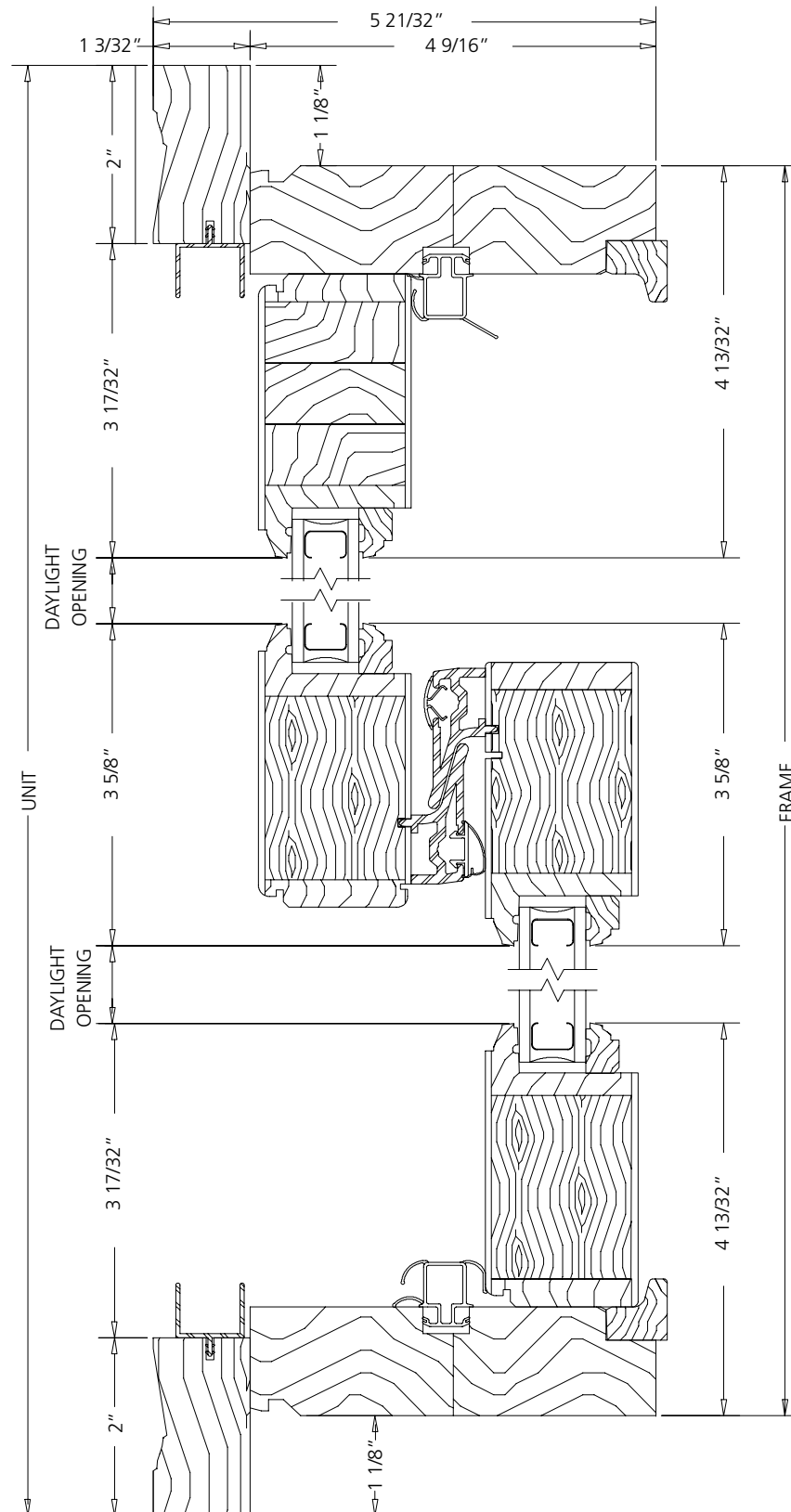

HORIZONTAL SECTION

**300 SERIES SIDELIGHT**

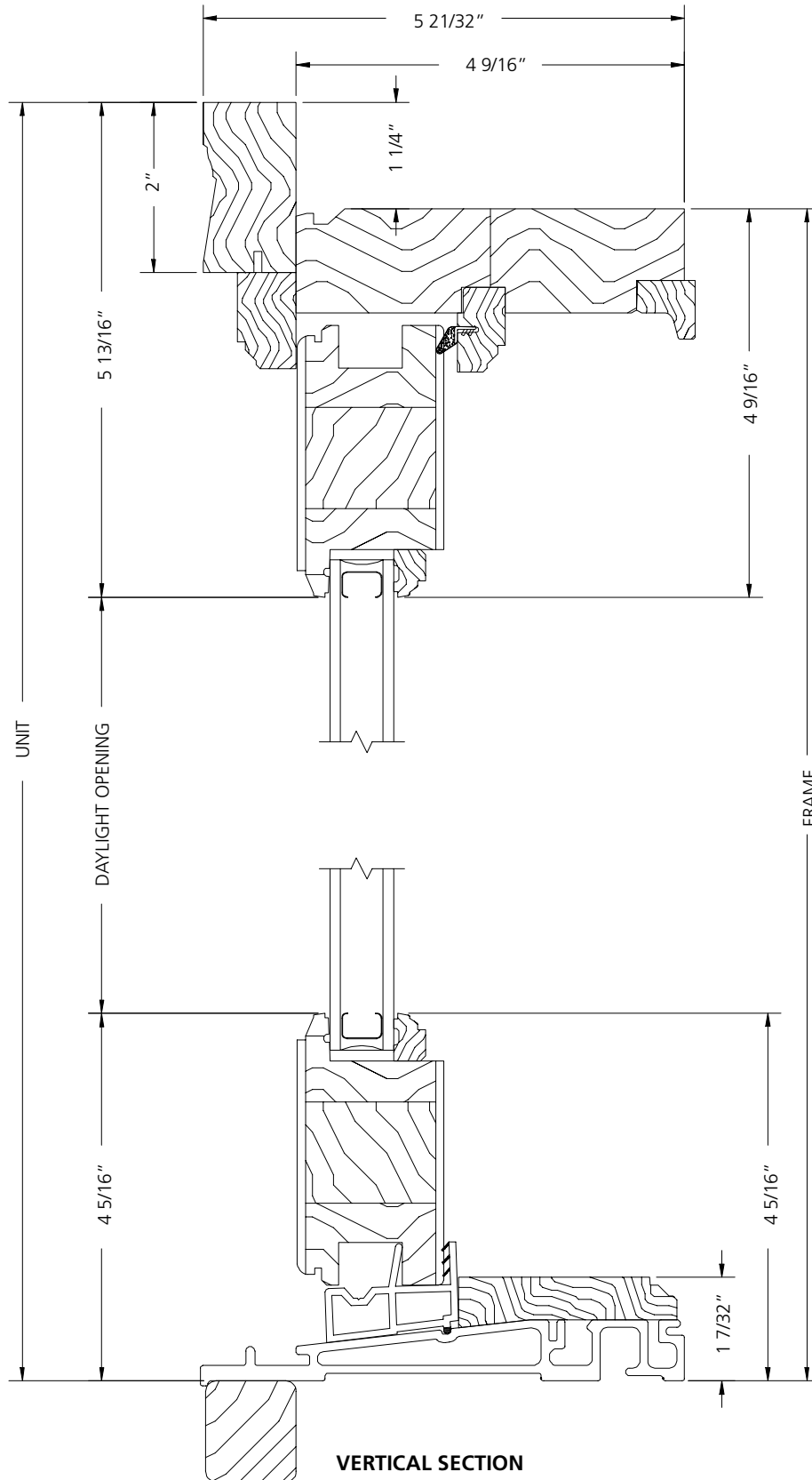

SCALE: 6" = 1'



**300 SERIES SIDELIGHT**

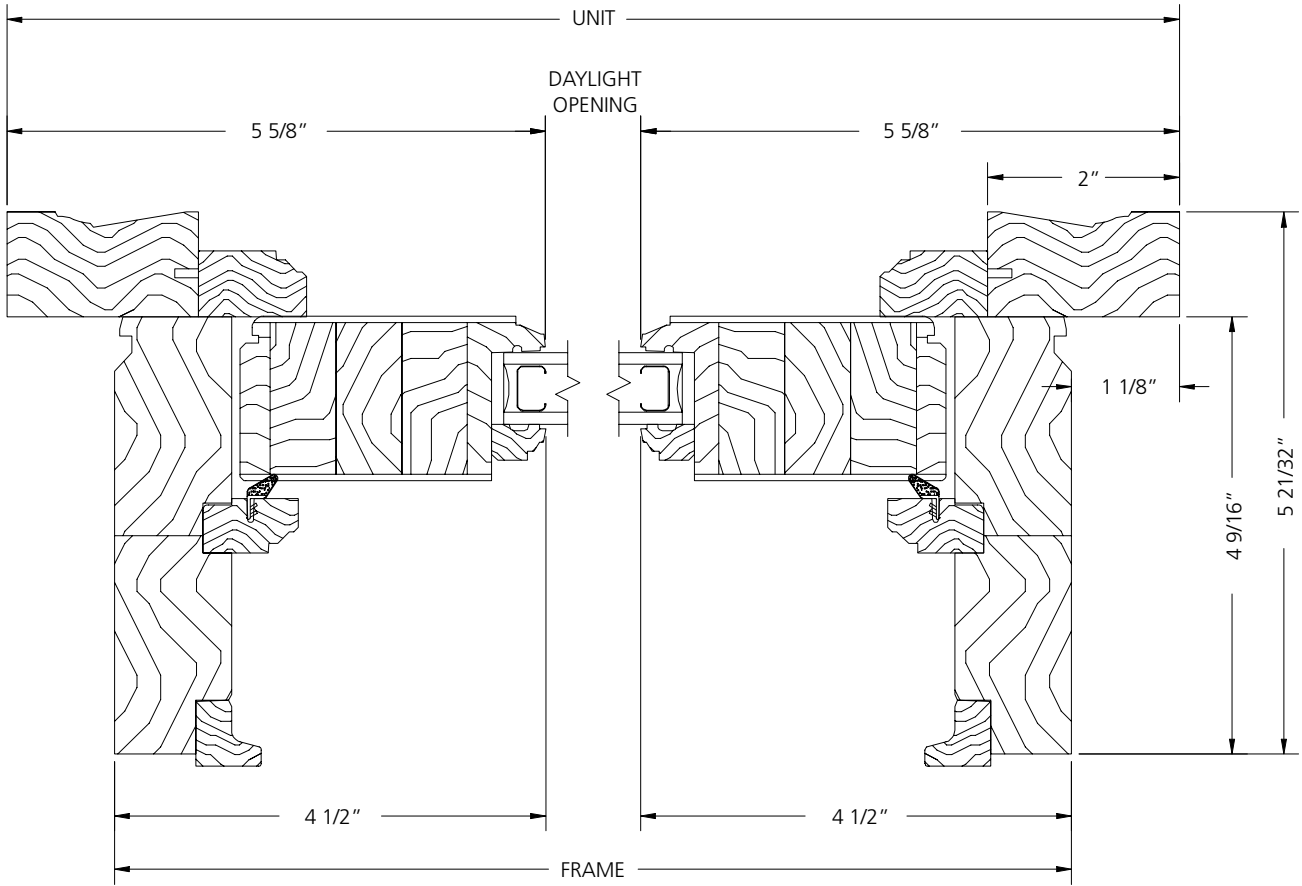

**HORIZONTAL SECTION**

SCALE: 6" = 1'

**300 SERIES SIDELIGHT MULLION DETAIL**

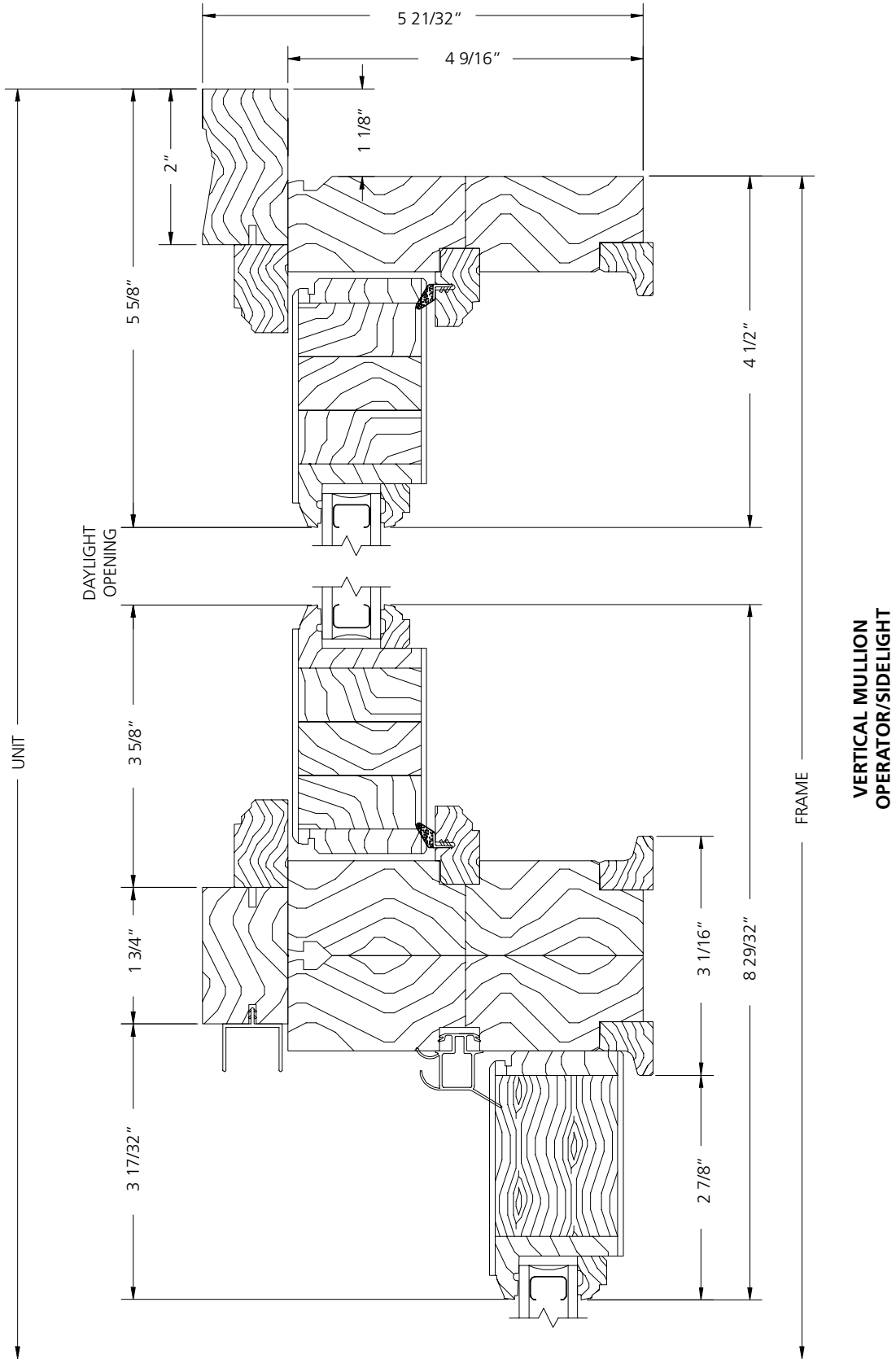

SCALE: 6" = 1'

**300 SERIES 4-PANEL SLIDING PATIO DOORS**

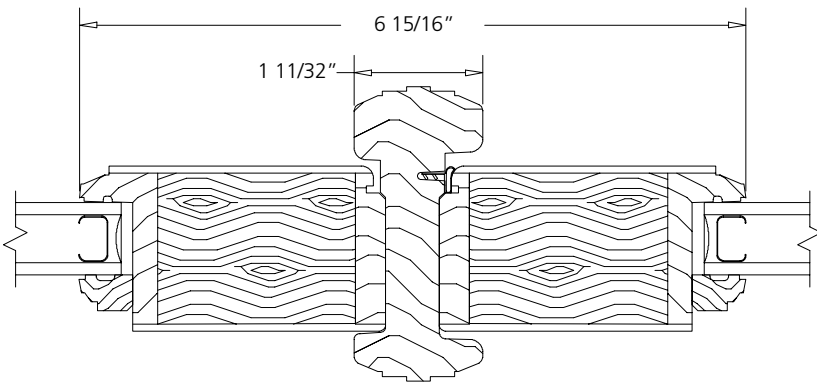
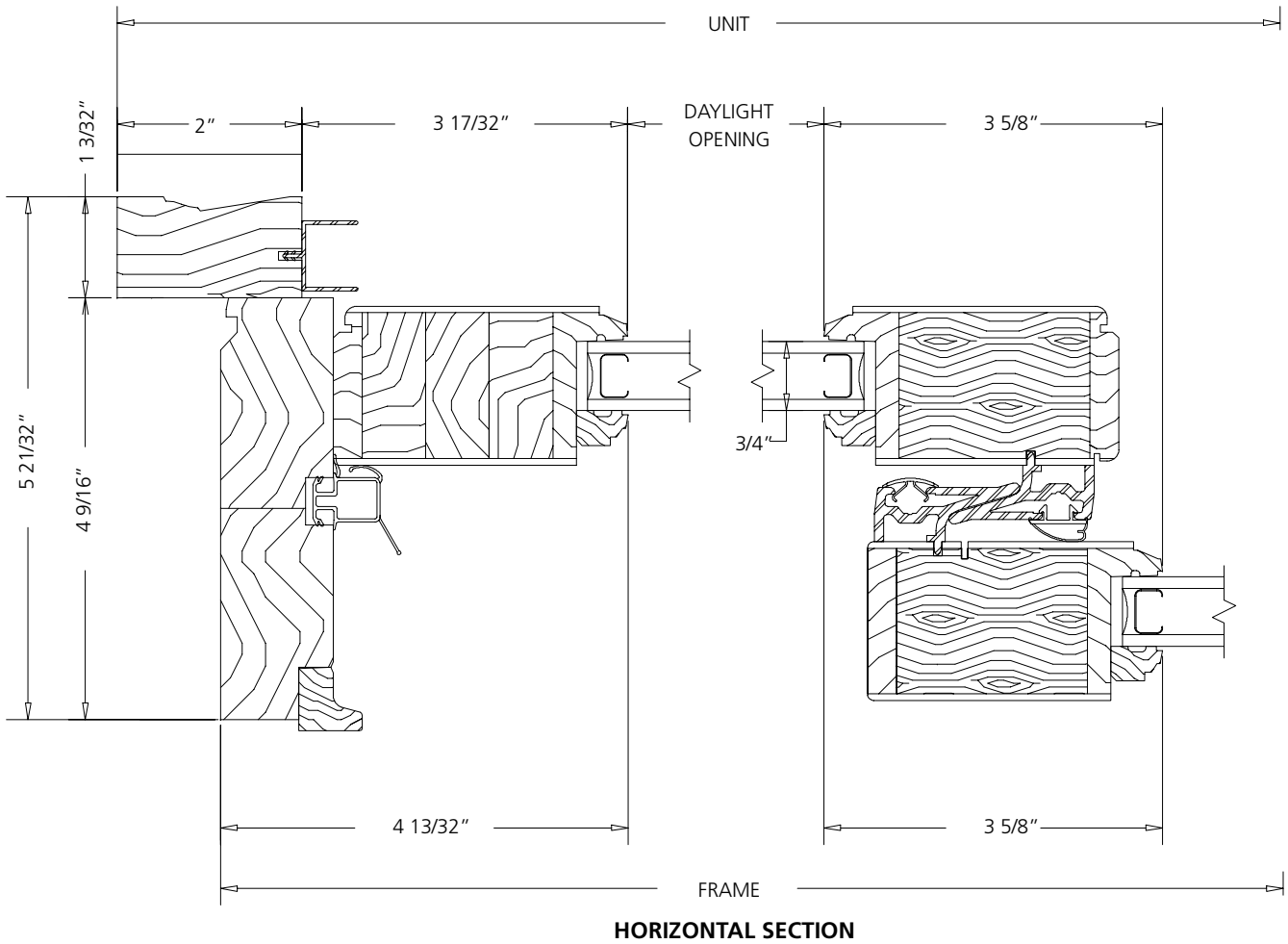

**ASTRAGAL DETAIL**  
**VIEW A-A**

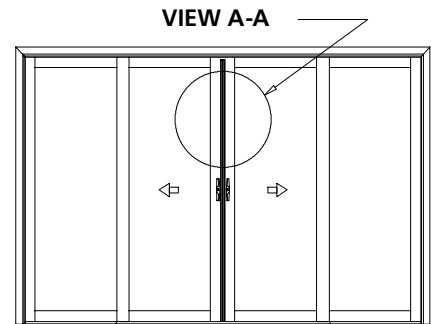

SCALE: 6" = 1'

**300 SERIES SLIDING DOOR TRANSOMS**

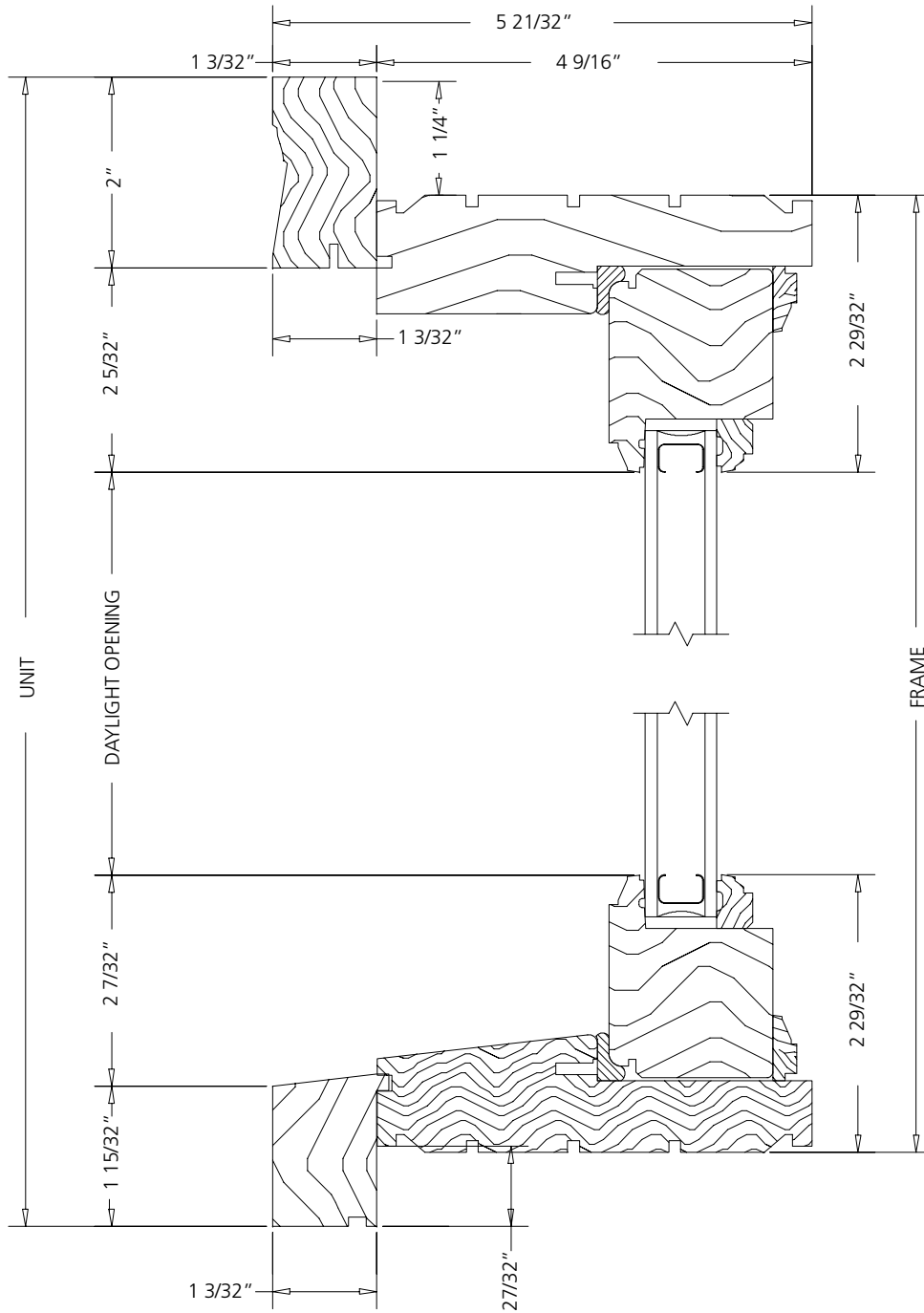

**VERTICAL SECTION**

SCALE: 6" = 1'

**300 SERIES SLIDING DOOR TRANSOMS**

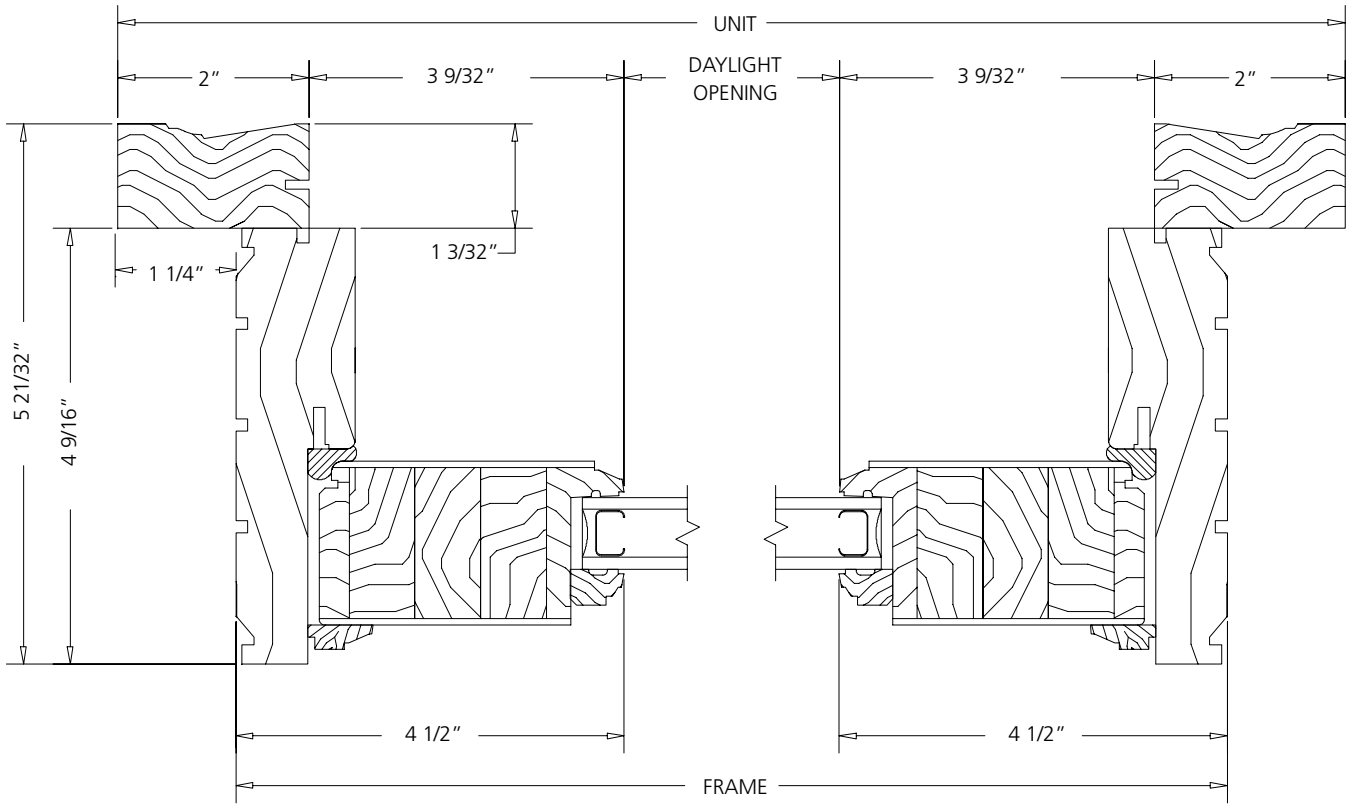

**HORIZONTAL SECTION**

SCALE: 6" = 1'

**300 SERIES SLIDING DOOR JAMB DETAILS**

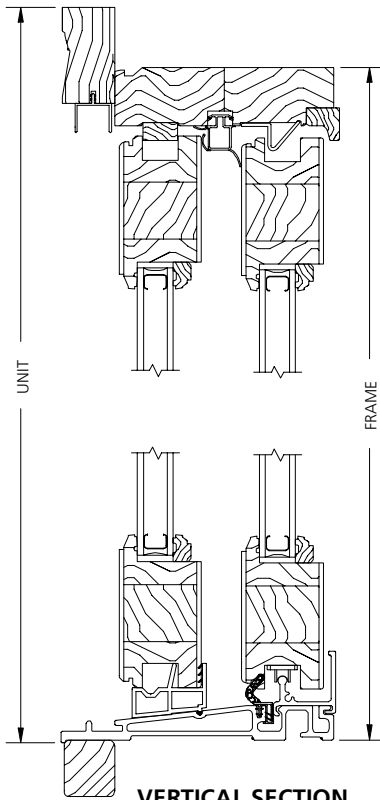

**VERTICAL SECTION  
4 9/16" JAMB**

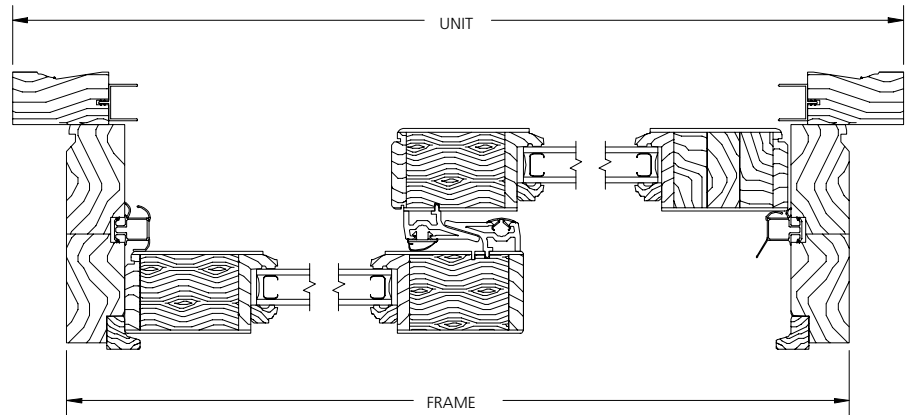

**HORIZONTAL SECTION  
4 9/16" JAMB**

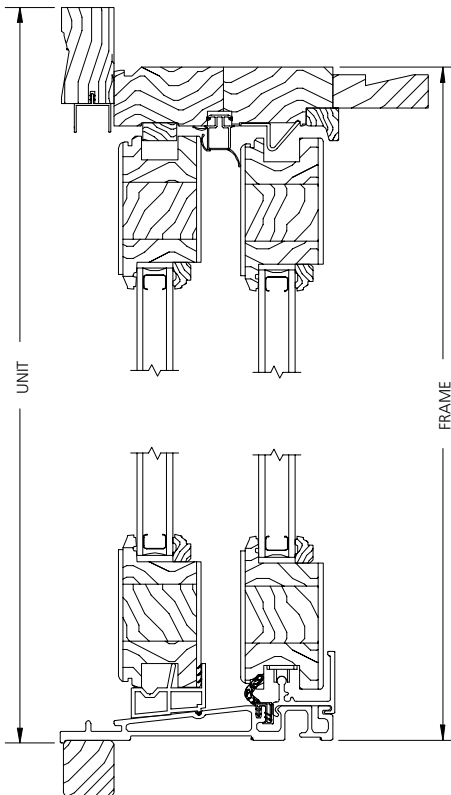

**VERTICAL SECTION  
6 9/16" JAMB**

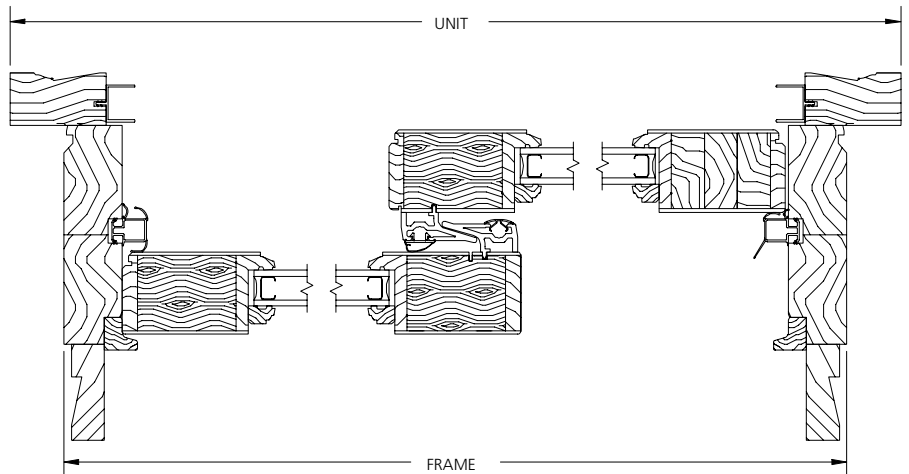

**HORIZONTAL SECTION  
6 9/16" JAMB**

SCALE: 3" = 1'

300 SERIES 4-PANEL SLIDING PATIO DOORS

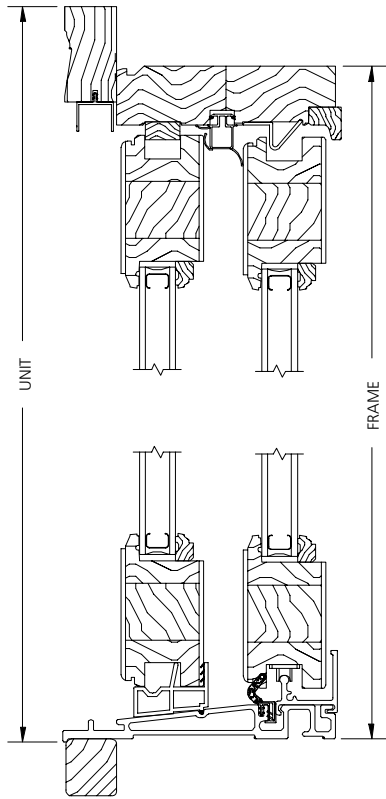

**VERTICAL SECTION**

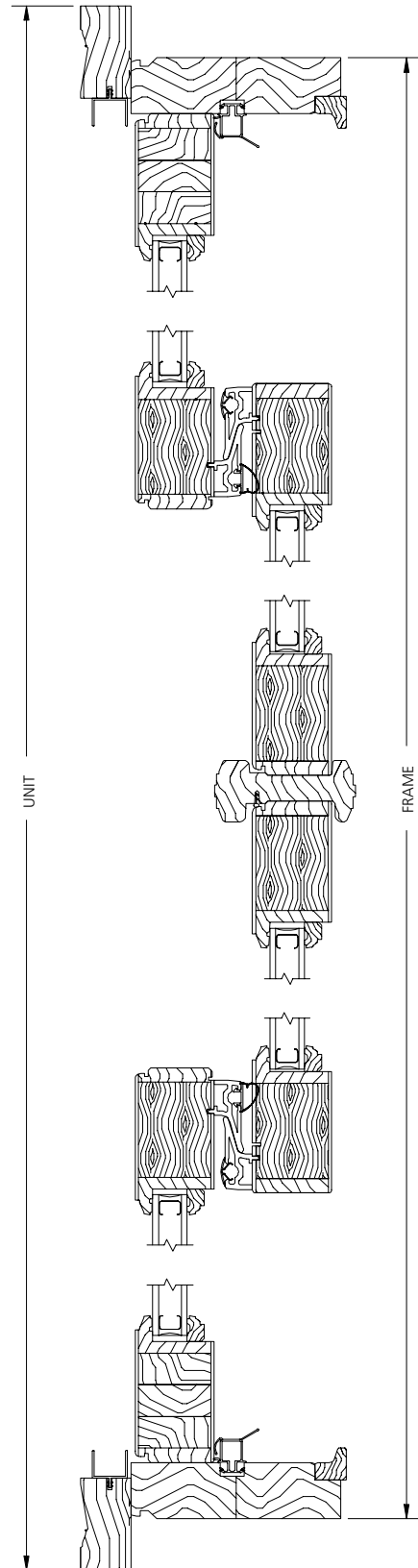

**HORIZONTAL SECTION**

SCALE: 3" = 1'

300 SERIES SIDELIGHT

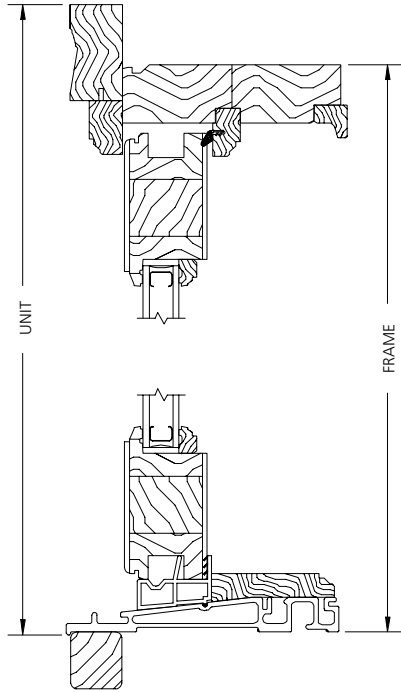

**VERTICAL SECTION**

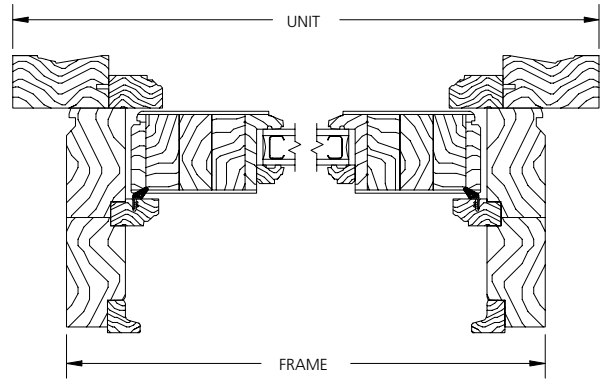

**HORIZONTAL SECTION**

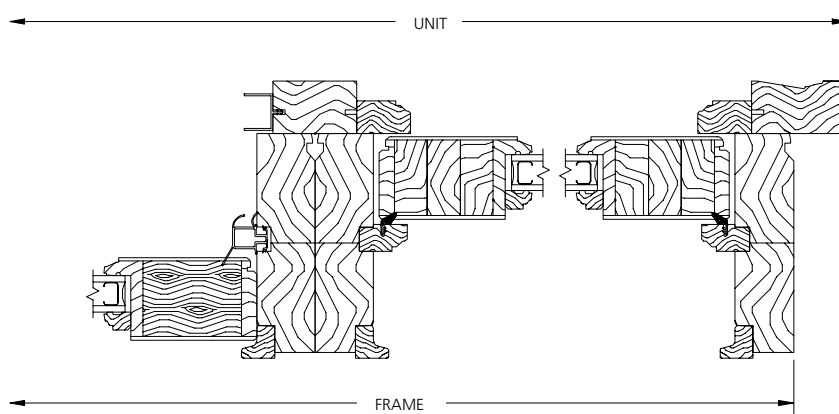

**VERTICAL MULLION  
OPERATOR/SIDELIGHT**

SCALE: 3" = 1'



**300 SERIES SLIDING PATIO DOOR  
WITH APPLIED FLAT CASING**

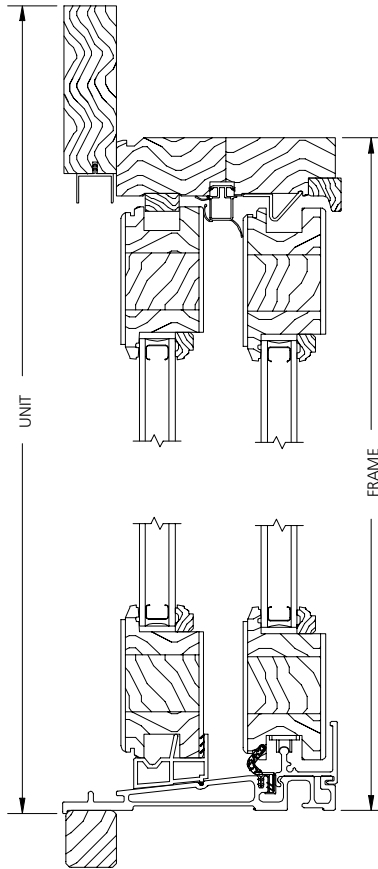

**VERTICAL SECTION  
3 1/2" FLAT CASING**

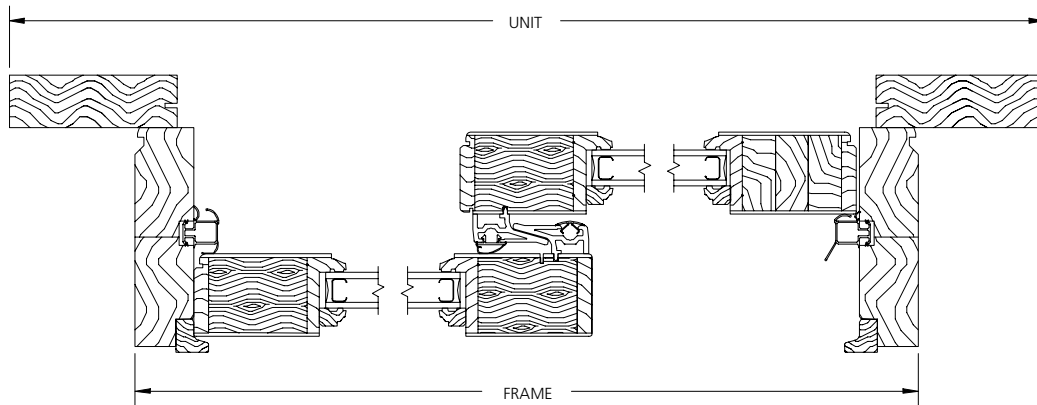

**HORIZONTAL SECTION  
3 1/2" FLAT CASING**

SCALE: 3" = 1'

**300 SERIES SLIDING DOOR TRANSOMS**

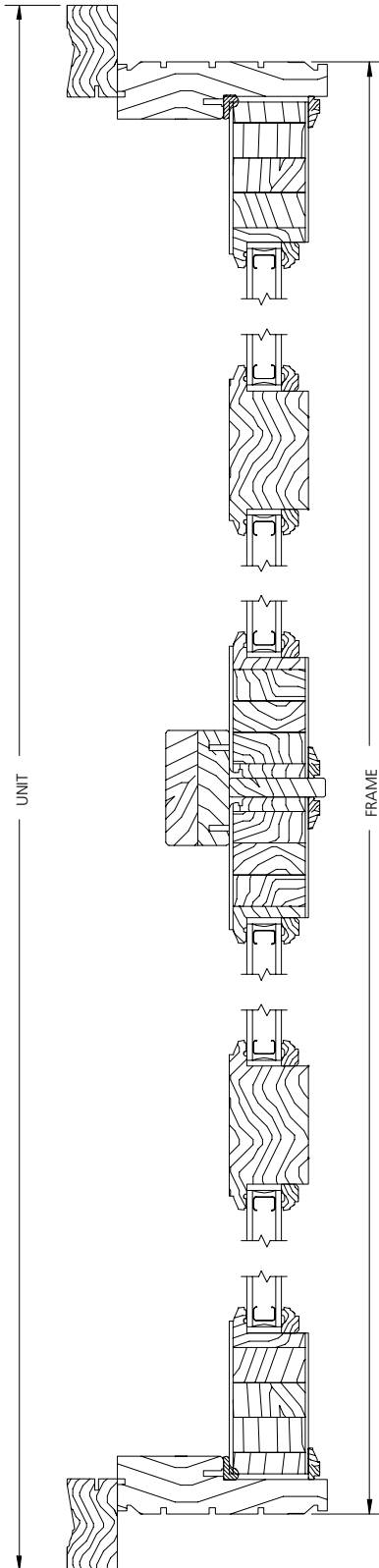

**HORIZONTAL SECTION**  
300 SERIES SLIDING DOOR TRANSOM  
2 PANEL - 4 LITE TRANSOM

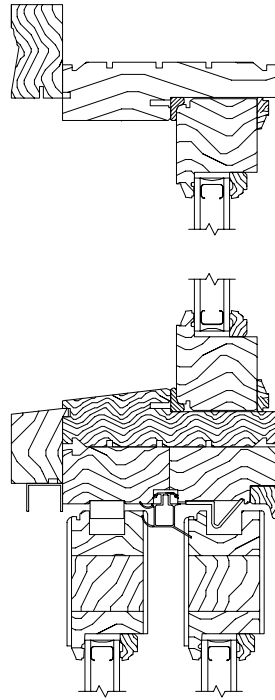

**HORIZONTAL MULLION**  
300 SERIES SLIDING DOOR TRANSOM  
MULLED ABOVE 300 SERIES SLIDING DOOR

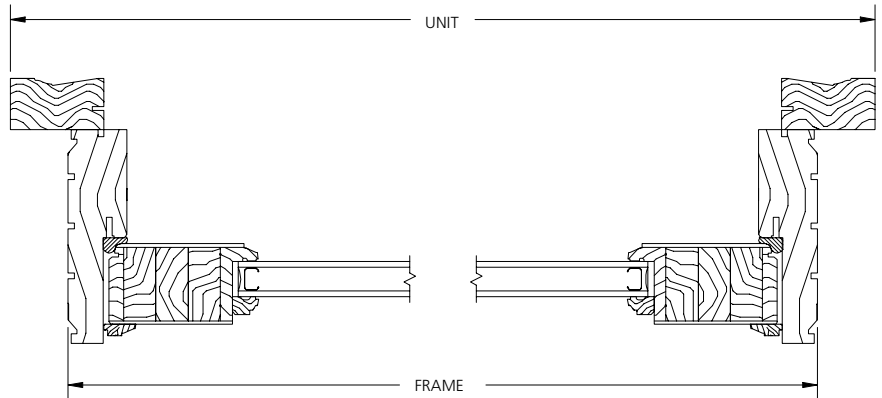

**HORIZONTAL SECTION**  
1 PANEL

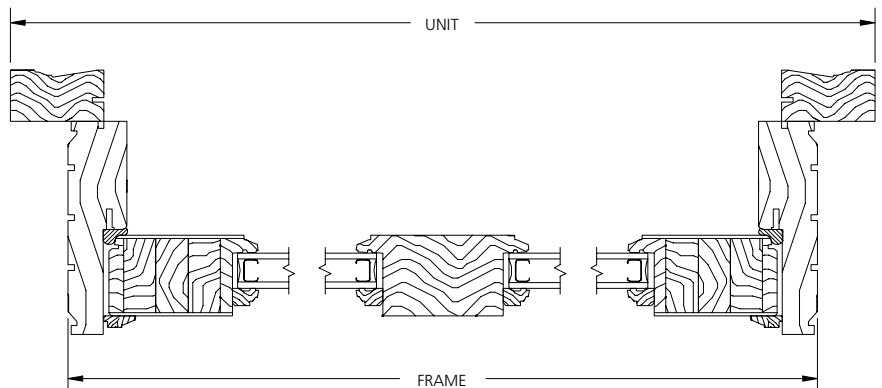

**HORIZONTAL SECTION**  
1 PANEL 2 LITE

SCALE: 3" = 1'

**400 SERIES SLIDING PATIO DOORS**

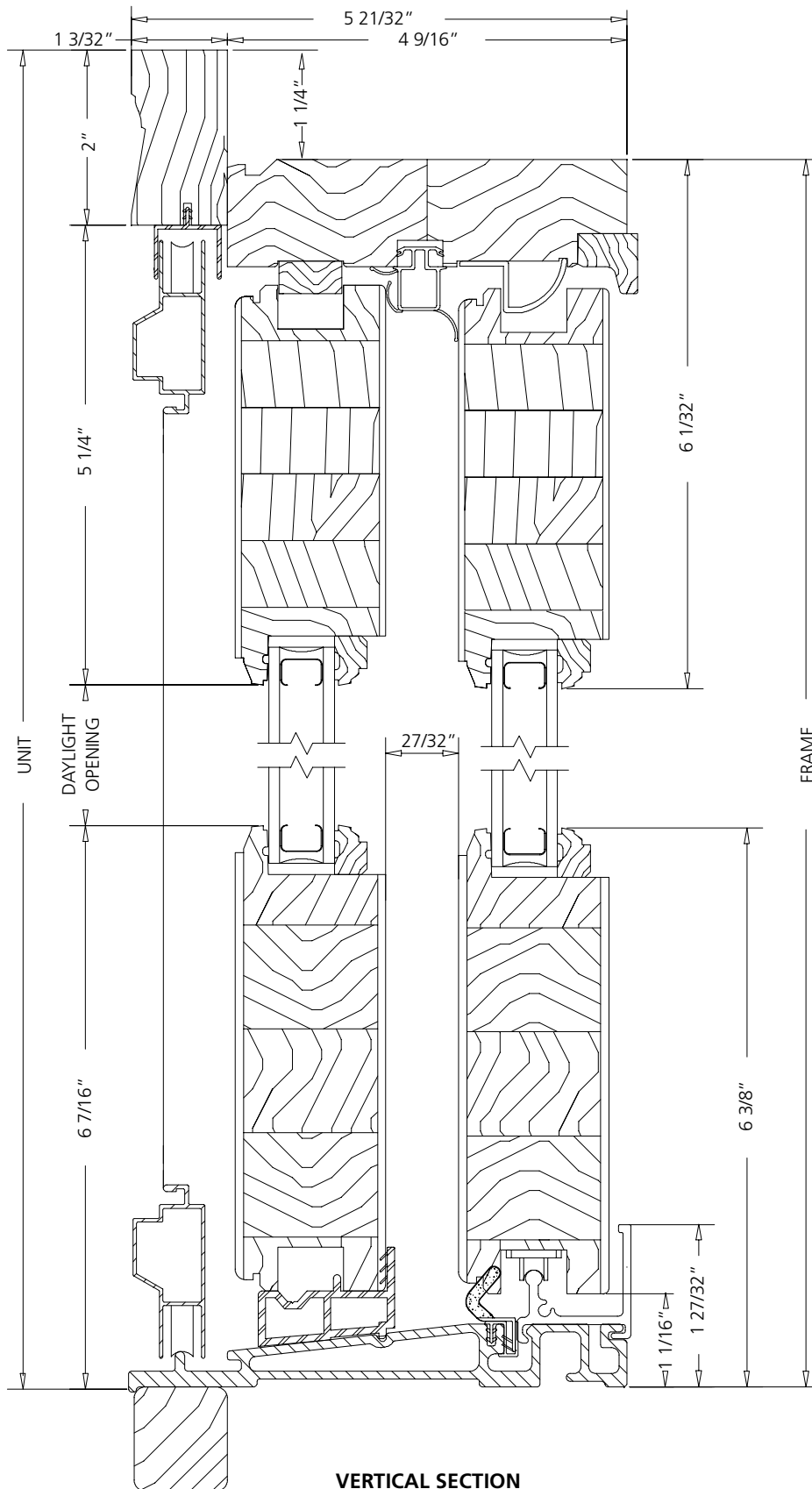

**VERTICAL SECTION**

**Note:** Bottom rail shown is for 6'-8" units. Bottom rail is 3" taller for doors over 6'-8".

SCALE: 6" = 1'

**400 SERIES SLIDING PATIO DOORS**

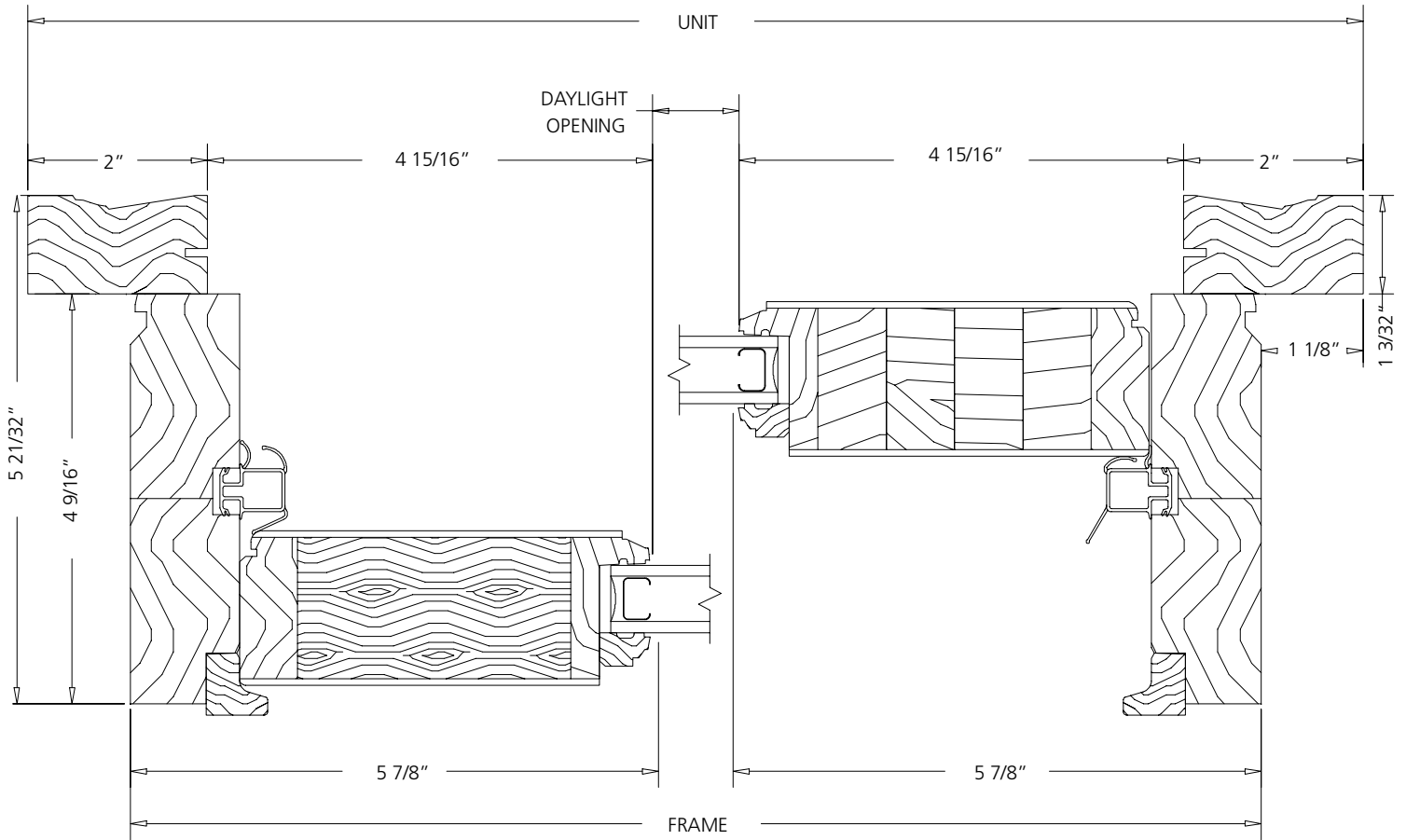

**HORIZONTAL SECTION**

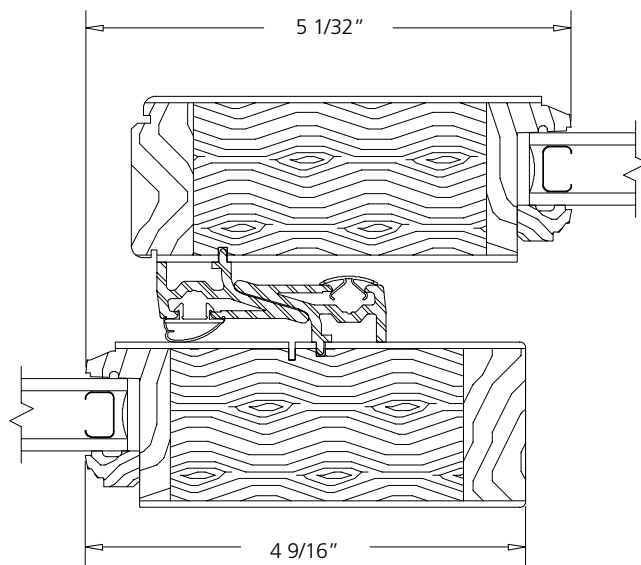

**INTERLOCK SECTION**

SCALE: 6" = 1'

**400 SERIES SIDELIGHT**

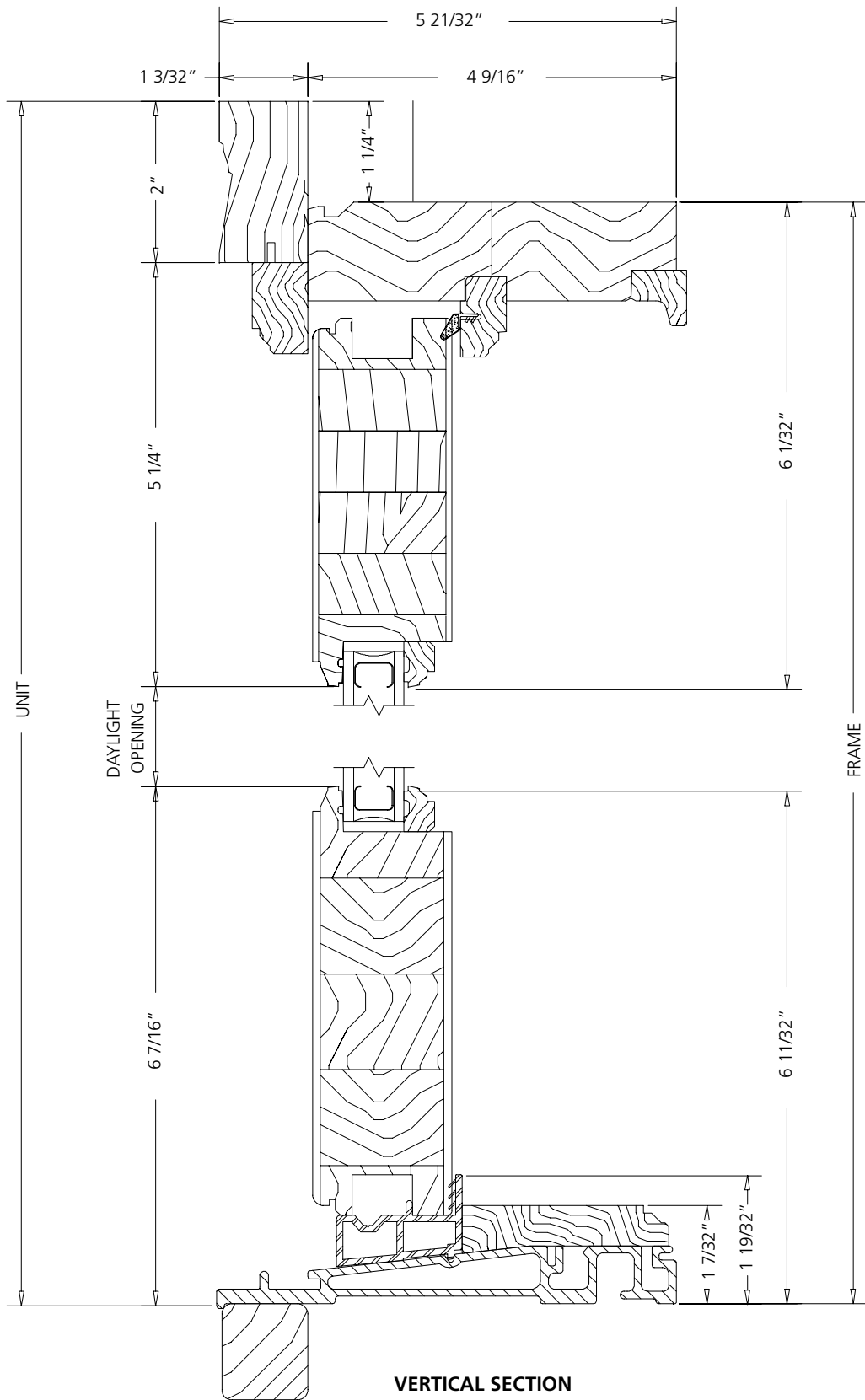

**VERTICAL SECTION**

**Note:** Bottom rail shown is for 6'-8" units. Bottom rail is 3" taller for doors over 6'-8".

SCALE: 6" = 1'

**400 SERIES SIDELIGHT**

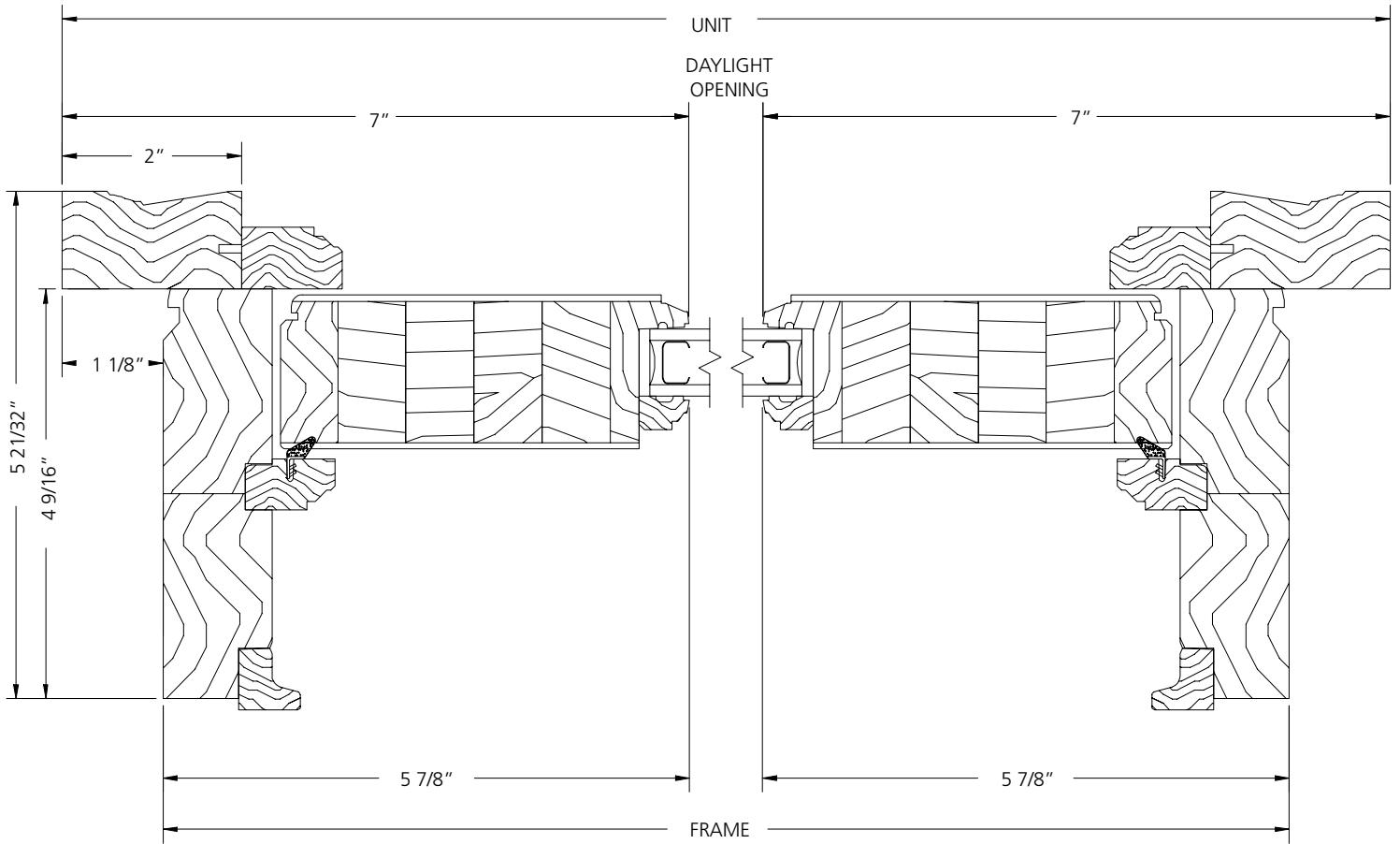

**HORIZONTAL SECTION**

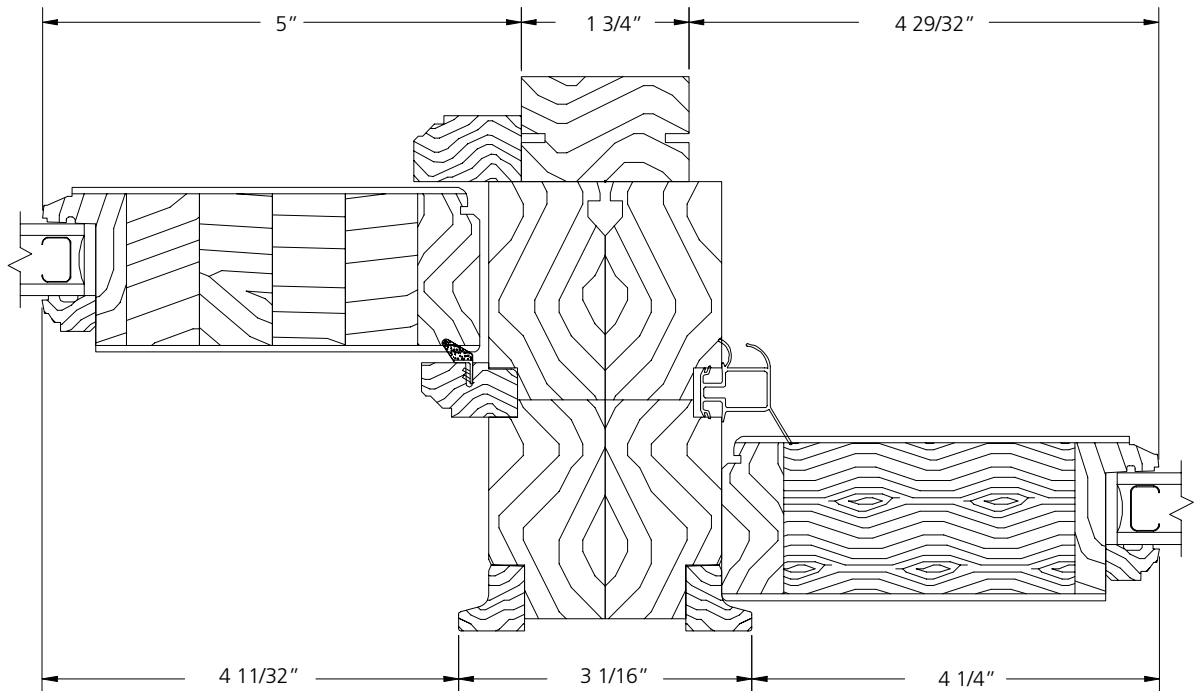

**VERTICAL MULLION  
SIDELIGHT/OPERATOR**

SCALE: 6" = 1'

**400 SERIES 4-PANEL SLIDING PATIO DOOR**

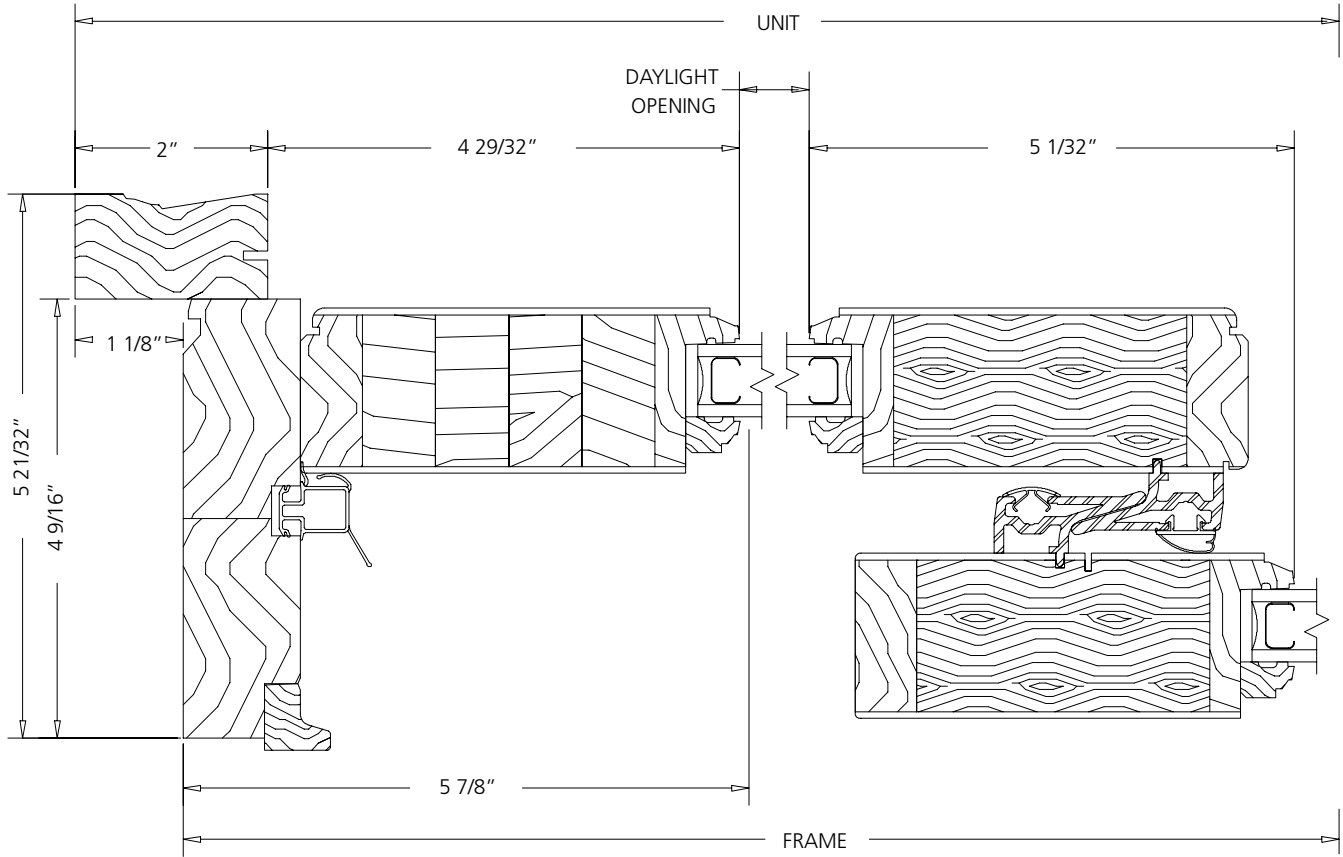

**HORIZONTAL SECTION**

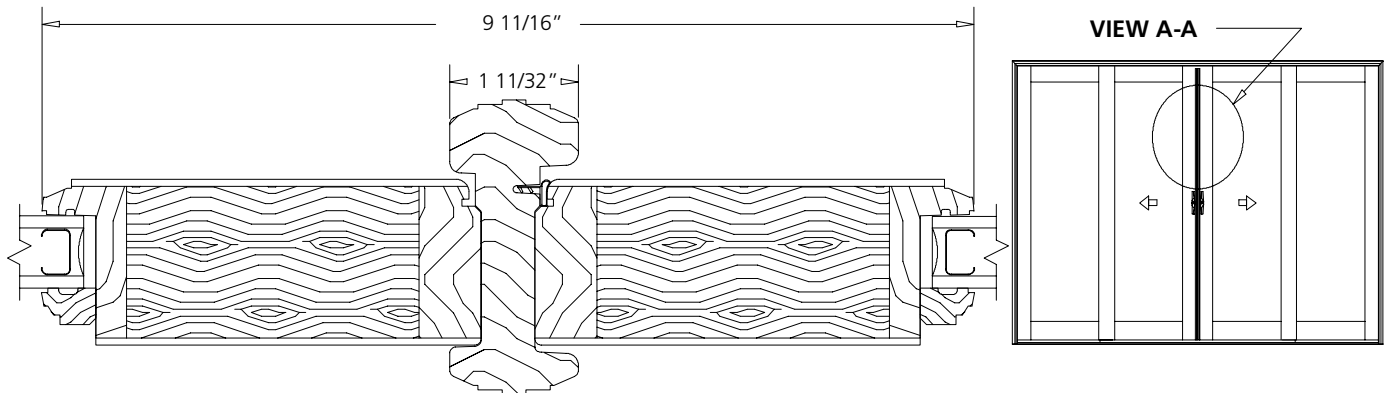

**ASTRAGAL DETAIL  
VIEW A-A**

SCALE: 6" = 1'

**400 SERIES SLIDING DOOR TRANSOM**

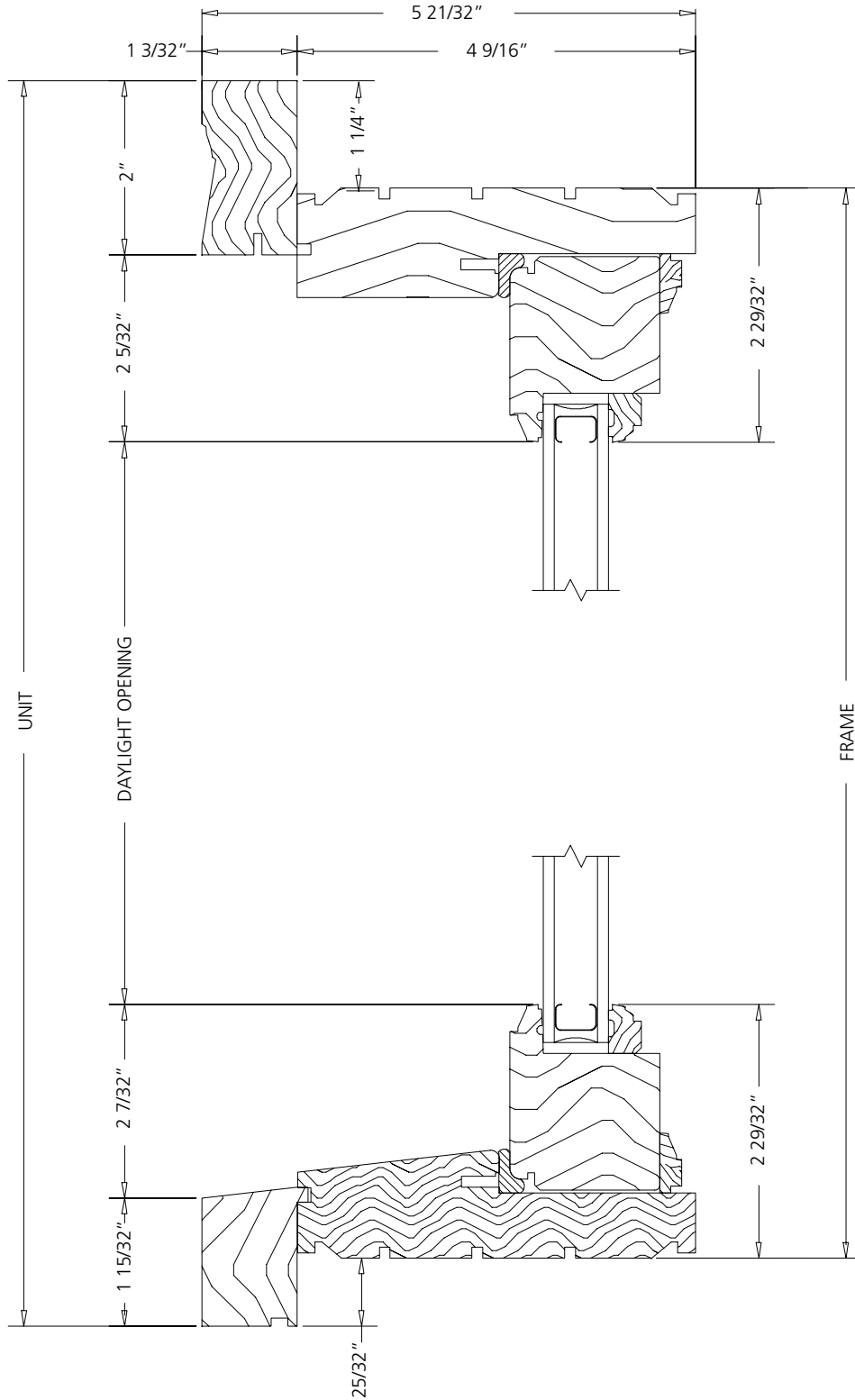

**VERTICAL SECTION**

SCALE: 6" = 1'



**400 SERIES SLIDING DOOR TRANSOM**

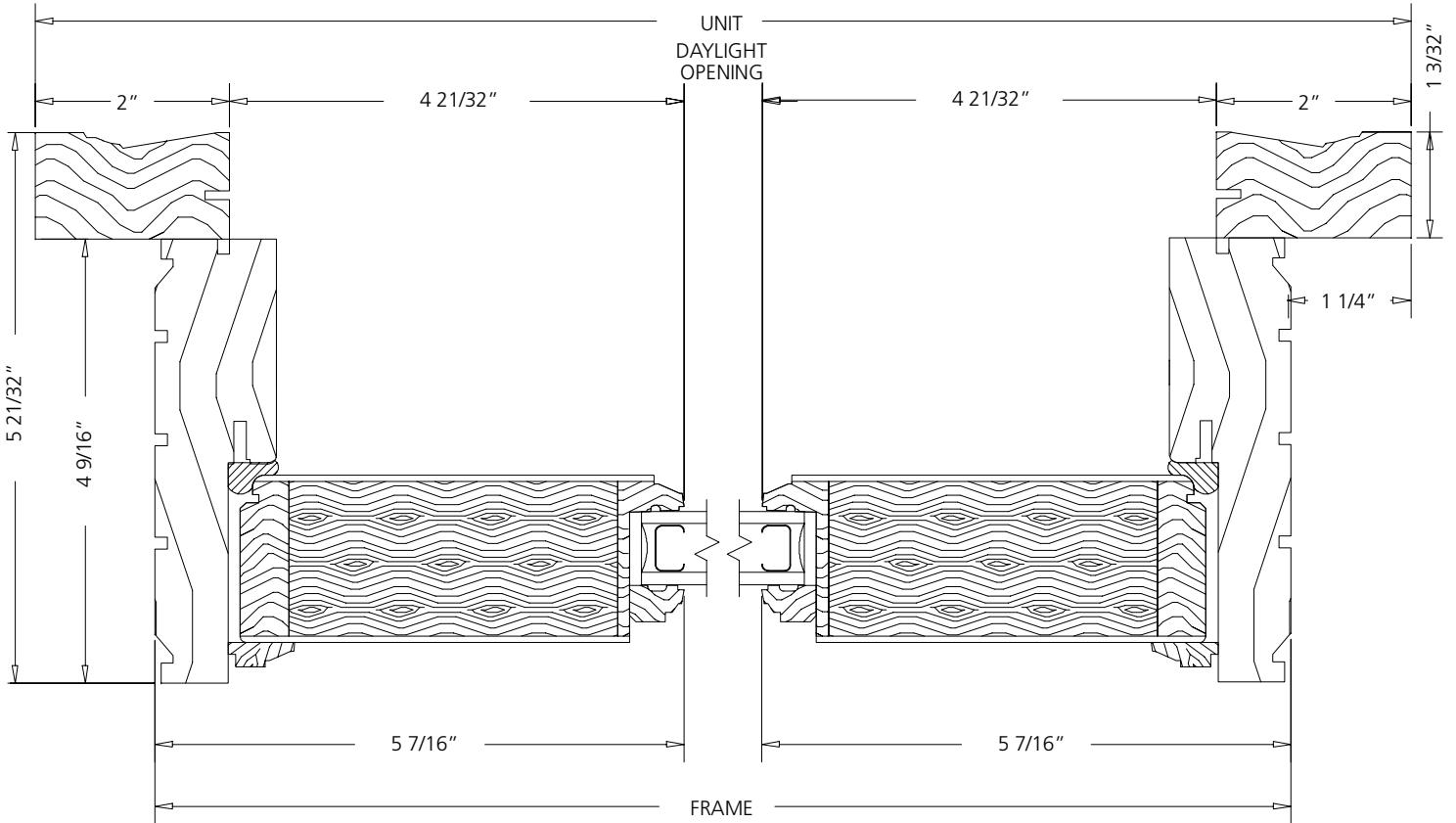

**HORIZONTAL SECTION**

SCALE: 6" = 1'

**400 SERIES SLIDING PATIO DOOR JAMB DETAILS**

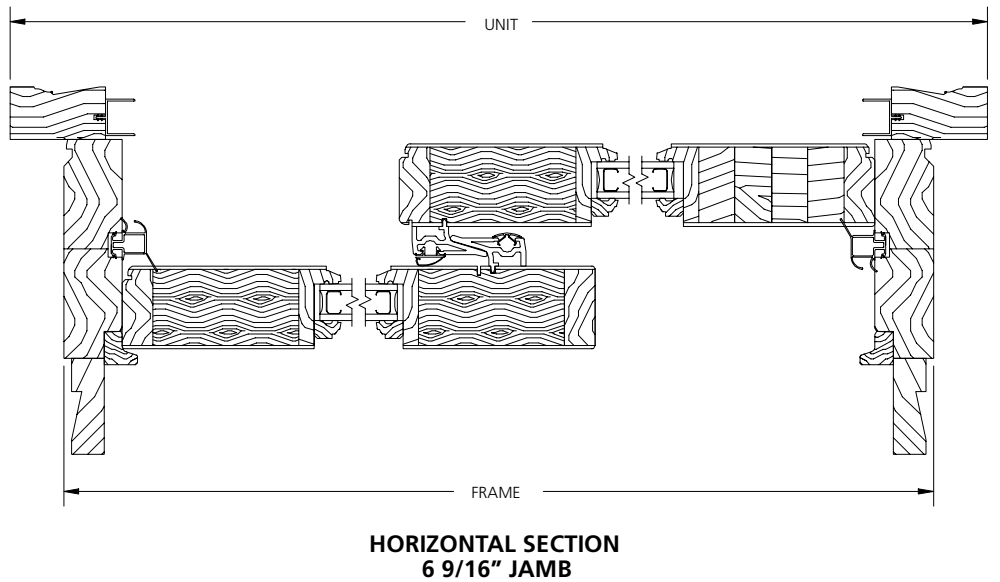
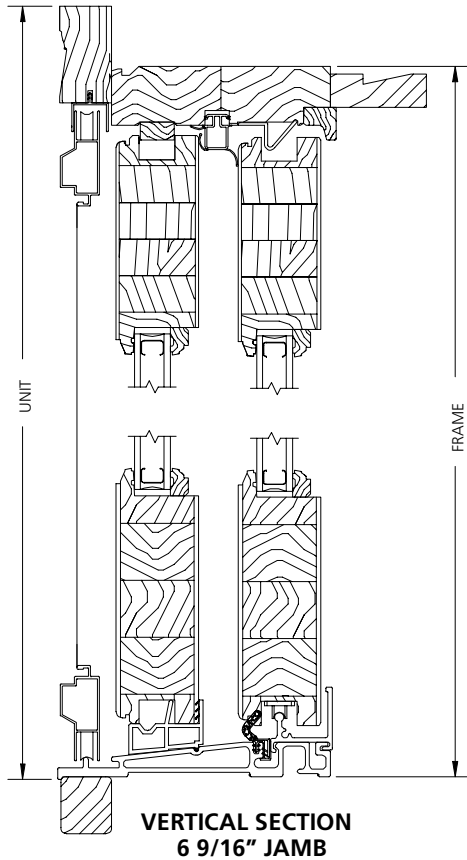
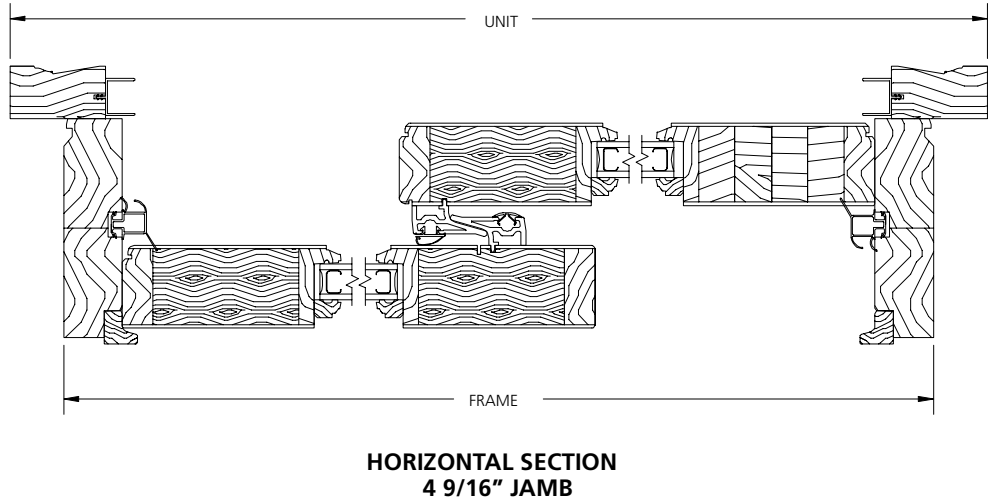
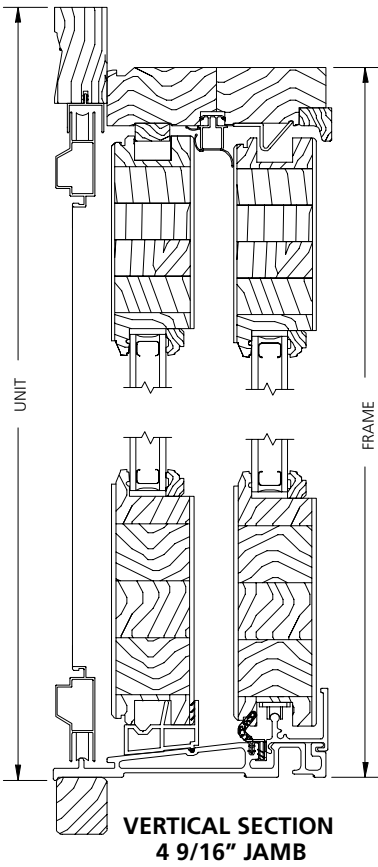

SCALE: 3" = 1'

400 SERIES 4-PANEL SLIDING PATIO DOORS

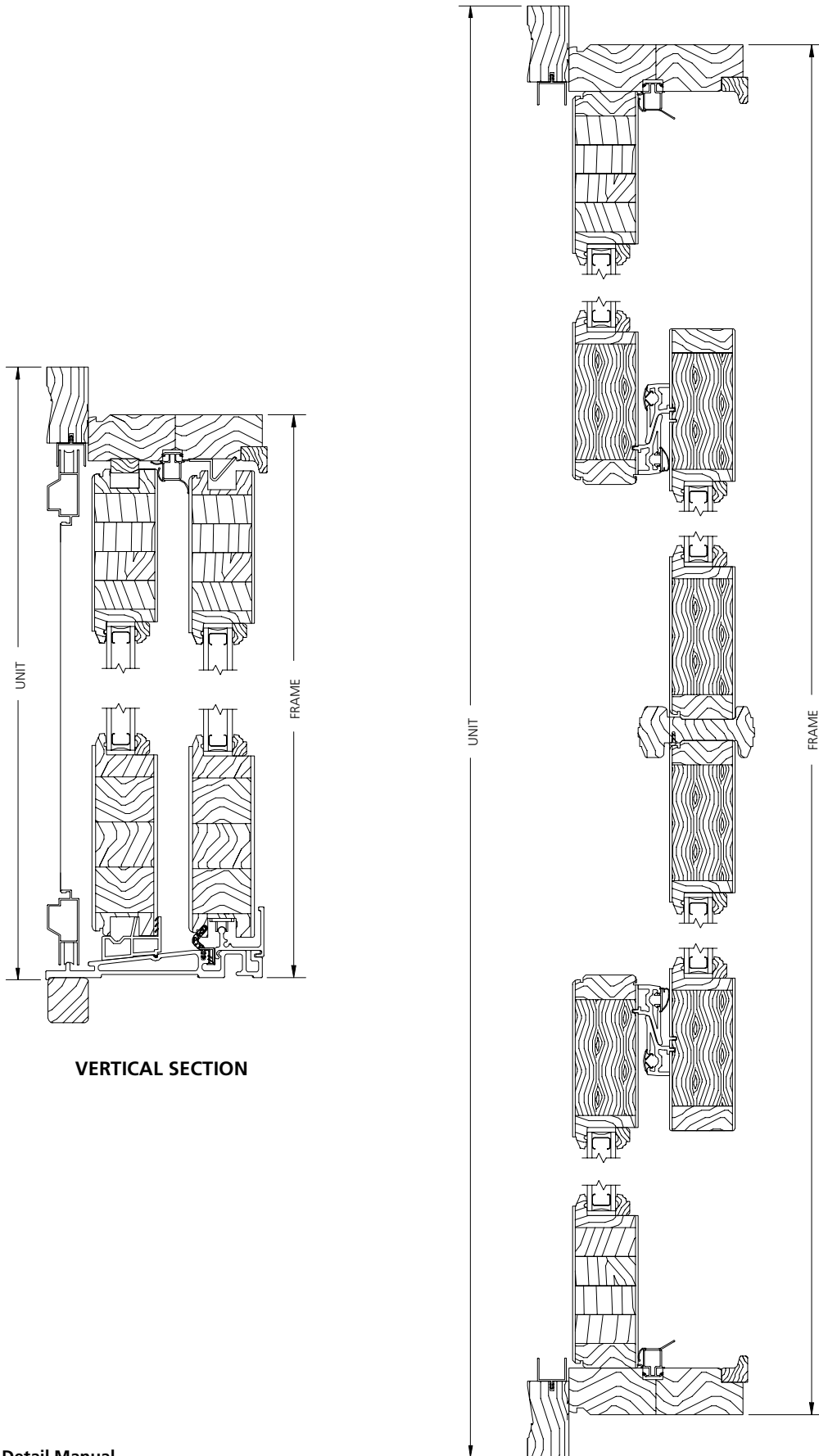

VERTICAL SECTION

HORIZONTAL SECTION

SCALE: 3" = 1'

400 SERIES SIDELIGHT

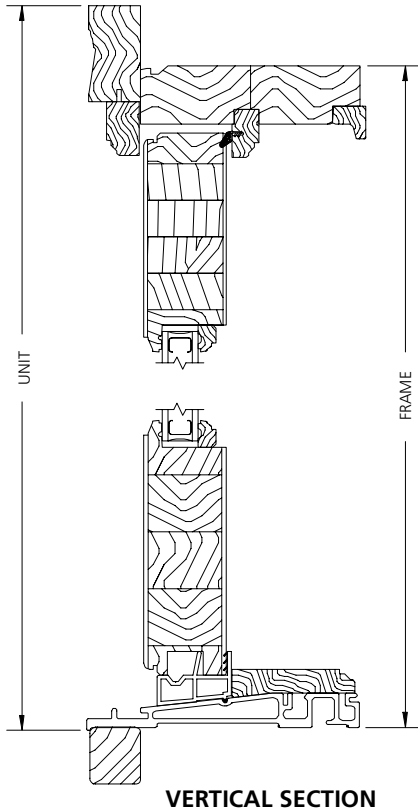

**VERTICAL SECTION**

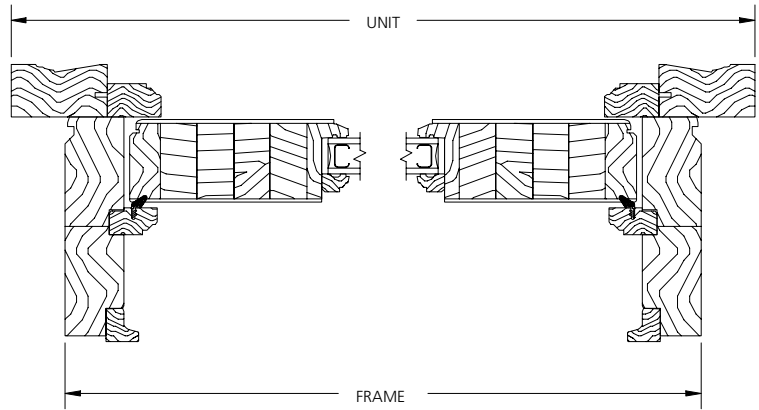

**HORIZONTAL SECTION**

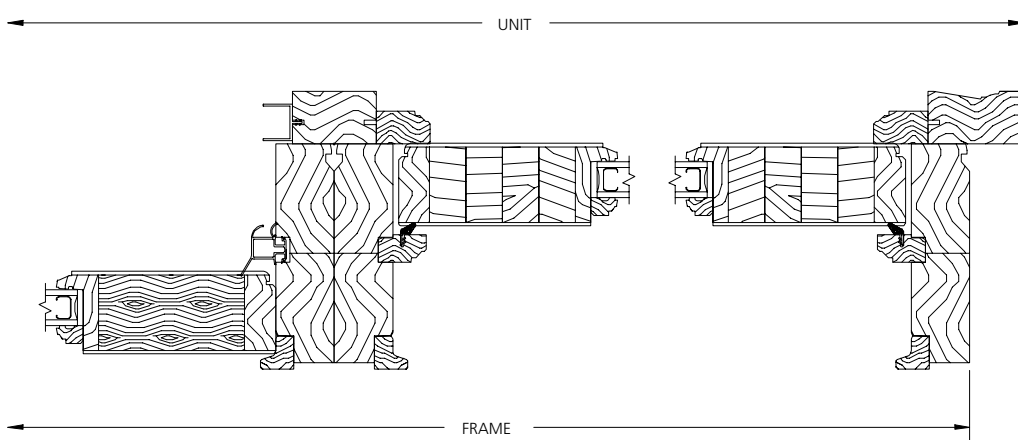

**VERTICAL MULLION  
OPERATOR/SIDELIGHT**

SCALE: 3" = 1'

**400 SERIES SLIDING PATIO DOOR  
WITH APPLIED FLAT CASING**

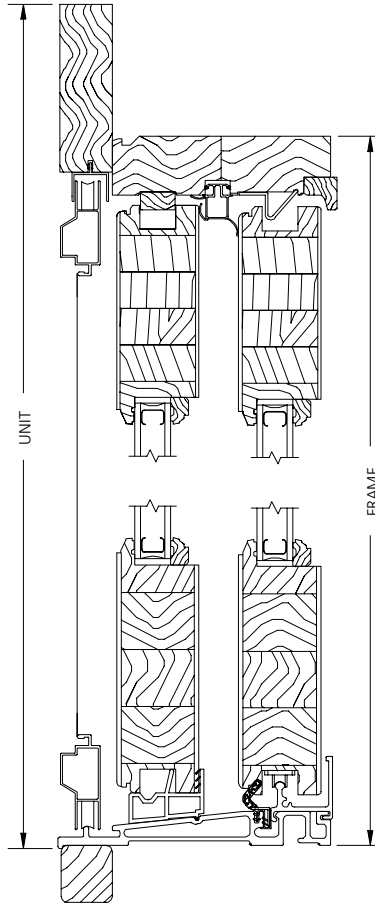

**VERTICAL SECTION  
3 1/2" FLAT CASING**

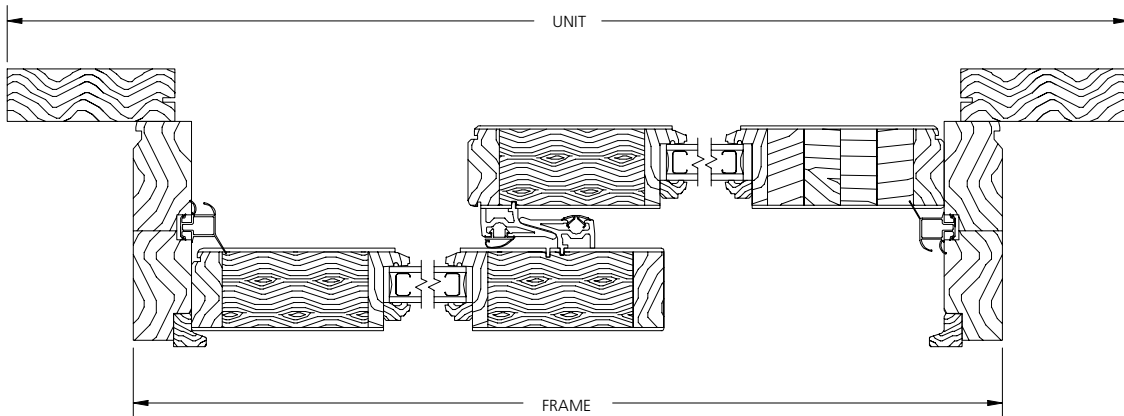

**HORIZONTAL SECTION  
3 1/2" FLAT CASING**

SCALE: 3" = 1'

**400 SERIES SLIDING DOOR TRANSOMS**

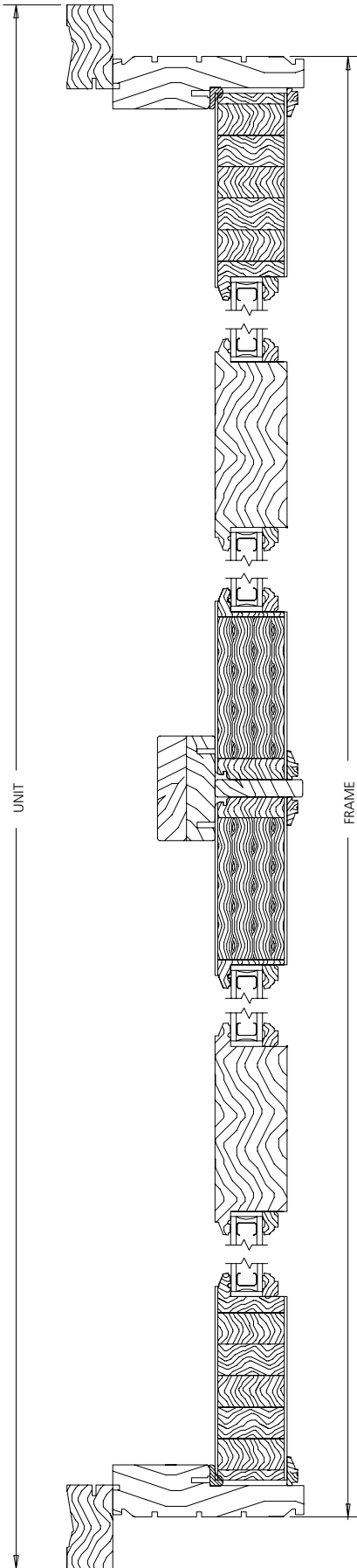

**HORIZONTAL SECTION**  
400 SERIES SLIDING DOOR TRANSOM  
2 PANEL - 4 LITE TRANSOM

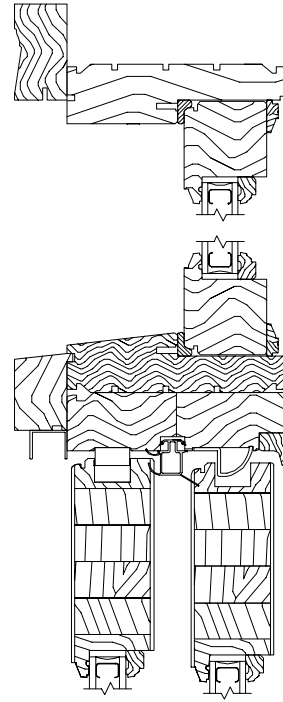

**HORIZONTAL MULLION**  
400 SERIES SLIDING DOOR TRANSOM  
MULLED ABOVE 400 SERIES SLIDING DOOR

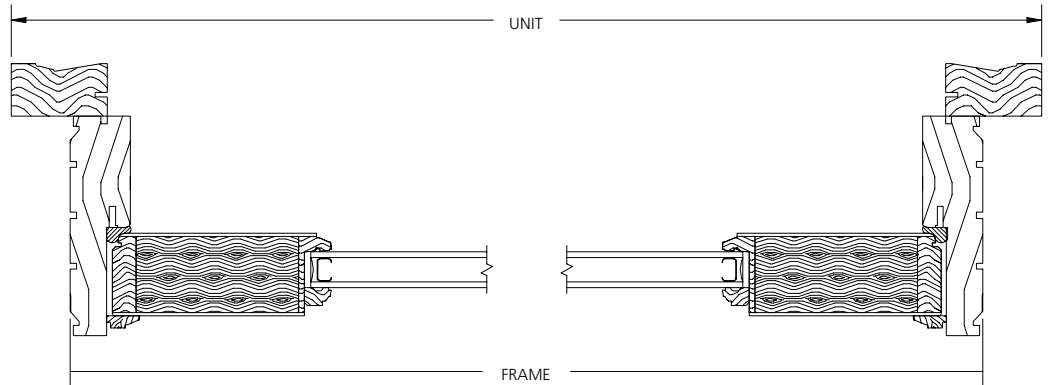

**HORIZONTAL SECTION**  
1 PANEL

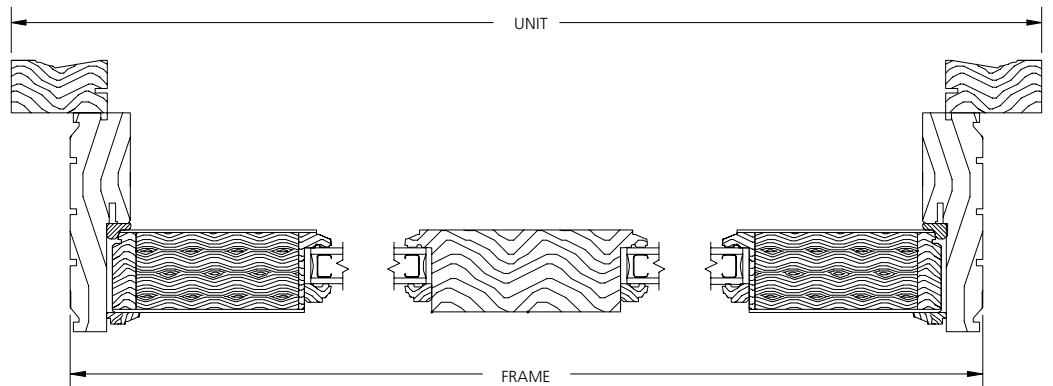

**HORIZONTAL SECTION**  
1 PANEL 2 LITE

SCALE: 3" = 1'