

TABLE OF CONTENTS

Specifications	15-2
Quick Spec Guide	15-6
Handing Codes	15-10
Elevations: 1/4" Scale	15-11
300 Series Sliding Patio Door	15-13
300 Series Transom Alignment Guide	15-18
300 Series Sliding Patio Door Transom	15-19
400 Series Sliding Patio Door	15-21
400 Series Transom Alignment Guide	15-26
400 Series Sliding Patio Door Transom	15-27
Panel Glazing Options: 3" Scale	15-29
Trim Options: 3" Scale	15-30
Lite Cut Information	15-31
Clear Opening and Daylight Specifications	15-34
Unit Sizing, Rough Openings, & Masonry Openings	15-37
Section Details: 6" Scale (300 Series Sliding Door)	15-38
Section Details: 3" Scale (300 Series Sliding Door)	15-46
Section Details: 6" Scale (400 Series Sliding Door)	15-51
Section Details: 3" Scale (400 Series Sliding Door)	15-58

PRODUCT SPECIFICATIONS: 300 SERIES SLIDING PATIO DOOR**EXTERIOR FINISH**

Exterior aluminum surfaces are low maintenance extruded aluminum coated with a thermo set polyester finish that meets or exceeds the AAMA 2603 performance standards. Standard colors include Brilliant White, Chestnut Bronze, Desert Sand, French Vanilla, Hartford Green, Mesa Red, Black, Arctic Silver and Dark Chocolate.

AURALAST® WOOD

AuraLast® wood is fundamentally different from wood resulting from traditional millwork preservation processes in that it uses a proprietary vacuum/pressure process to provide protection throughout the wood parts used to make windows and doors. AuraLast® wood is distinguished from wood using the current preservation methods by its unique ability to achieve greater penetration of the active ingredients into the wood parts, with a penetration of the treatment being a minimum of 92%.

INTERIOR FINISH

All interior surfaces are unfinished clear pine ready for on site finishing. Primed and pre-finished interiors are available in paint: Pure White, Extra White, Natural Choice, Moderate White; in stain: Wheat, Cherry, Cordovan; and Clear Lacquer.

FRAME

Frame is assembled from select kiln dried pine using AuraLast® wood on all exterior parts. Exterior surface of head and side jambs are covered with .050 (1.27mm) extruded aluminum cladding; corner joints are sealed with silicone and reinforced with a metal corner key and screw boss. Frames are finger jointed with an option for clear on most sizes. Frame thickness is 1-7/32" (31 mm) at head and side jamb and 11/16" (17.5mm) at sill. Basic jamb width is 4-9/16" (116mm) and may be extended for different wall depths. Integral nailing fin is part of head and side extrusion. Sill is constructed of a dark bronze one-piece pultruded fiberglass and a bronze anodized aluminum track. An integral wrapped foam sill weather-strip provides continuous seal against water and air infiltration. Two panel and four panel (quad) doors have continuous head and sill. Three panel units have separate sidelight field mullered to two-panel unit. Doors are shipped KD but factory assembly may be specified on most sizes as an option. Exterior of frame extrusion is grooved to accept accessories.

PANEL

Panel is 1-23/32" (43.7mm) thick select kiln-dried pine using AuraLast® wood and engineered wood substrate, which is water repellent preservative treated. Selected panel members have Timberstrand core for added strength and dimensional stability. Wood stiles and rails are 3-3/16" (81mm) in face width, machine clamped for square assembly, and joined with slot and tenon corners secured with metal fasteners. Exterior surfaces are covered with .050 (13mm) extruded aluminum with cope jointed and sealed corners. Operating door panel slides on inside track. Quad doors have two stationary and two operating panels with a center astragal applied to the secondary active panel. The primary active panel is the left center panel on quad doors (viewed from the building exterior) unless otherwise specified.

GLAZING

3/4" (19mm) thick sealed insulating glass is constructed from two panes of tempered glass, utilizing a continuous roll formed stainless steel spacer with dual seal sealant. A computer-controlled application of clear silicone is used to bed the exterior of the insulating glass into the panel. An acrylic sealant is used to bed the interior. All insulating glass units comply with the performance requirements of IGCC in accordance with either ASTM E774 or E2190.

GLAZING OPTIONS

3/4" insulating glass available in Low-E with Argon, Low-E, Low-E 366, Clear, Neat Glass, reflective, tinted, or obscure, tempered or other specialty glass as specified. Preserve® film is a 0.003" thick polyethylene film with a low tack acrylic adhesive applied to the glass for protection during shipping and installation. 4,000 foot elevations and higher require a capillary tube to equalize environmental stress (otherwise known as High Altitude glazing). High Altitude glazing does not allow the use of Argon as listed under glazing options.

WEATHER-STRIPPING

Engineered system combines a rigid vinyl parting stop weather-strip with flexible leaves at the head and side jambs. A rigid vinyl interlock is applied to the meeting stiles of both the operating and stationary panels and sealed with a thermoplastic weather-strip. The sill track incorporates a wrapped foam weather-strip which contact the bottom edge of the operating panel as well as the dense pile dust plug at the bottom of the meeting stiles. The stationary panel setting block incorporates dual durometer vinyl weather-strips. The operating panel is guided by a rigid vinyl track at the head jamb. All weather-strips except sill are Ivory colored.

HARDWARE

Operating panel rides on two sets of adjustable, tandem, steel ball bearing rollers. Standard handle incorporates a positive locking mechanism with adjustable throw latch and oak interior hand pull. Quad door includes dummy handle. Doors come with a brown finished wood interior handle with black exterior hand pull. Handle set is also available in Bright Brass, Antique Brass, Polished Chrome, Brushed Chrome, Powder Coat White, or Oil Rubbed Bronze finish. Optional lock cylinders are keyed Weiser and may be re-keyed locally to match other doors. Optional multi-point lock is available with solid brass handle in Bright Brass, Antique Brass, or Brushed Chrome finish. Lock cylinder for multi-point lock is standard with Schlage "C" keyway.

EXTERIOR INSECT SCREENS

Charcoal fiberglass screen cloth (18x16 mesh) with clad color matched .040" (1mm) extruded aluminum frame. Door screen rides on a set of two adjustable steel rollers at both top and bottom of the screen and operates on outside track. Quad doors have two screens with field-applied astragal. Insect screens are intended to allow air and light in and to keep insects out. They are not intended to keep anyone or anything from falling through an open door. For safety screens or other security devices contact your local building supply retailer.

GRILLES

SDL (Simulated Divided Lites) - extruded aluminum muntins permanently applied to the exterior of the insulating glass unit (not available on textured glass) in 7/8" (22mm), 1-1/8" (28.5mm), or 1-3/8" (34.9mm) widths. SDL is standard with a light bronze internal shadow bar to give a true divided lite appearance. As an option, SDL may be ordered with a silver shadow bar. Clear wood interior muntin bars match the exterior muntin width and are permanently bonded to the interior of the glass. Also available is a 2-5/16" (59mm) SDL bar, which simulates a double-hung checkrail.

Full Surround Wood Grilles - Rectangular unfinished clear pine wood grilles in 7/8" (22mm) are available in patterns selected by the owner.

GBG (Grilles between the Glass) - 5/8" (15.9mm) flat and 23/32" or 1" contour mounted between the glass panes suspended within the air cavity.

Continued on next page

PRODUCT SPECIFICATIONS: 300 SERIES SLIDING PATIO DOOR

EXTERIOR TRIM

1-5/8" (41mm) wide aluminum brickmould with an integral nailing fin is available factory applied. Also available is 3-1/2" (88.5mm) flat or Adams casing with an integral nailing fin. 1-1/2" retrofit brickmould casing is available as well. All of the accessories are .050" (1.3mm) extruded aluminum. Two sizes of frame expander, 1-7/8" (48mm) and 3-1/4" (83mm) may be used alone or in conjunction with a 2-1/8" (54mm) mull expander. Color and finish match exterior finish specs above.

EXTENSION JAMBS

Extension jambs are shipped loose on KD doors. Extensions are applied to the interior of head and sides of the frame and are 21/32" (16.7mm) thick pine to accommodate wall depths up to 9-5/16" with one piece, and up to 12" with two pieces.

HANDING

Operation should be specified as left or right as viewed from building exterior. 6-8 and 6-11 height 300 Series Patio doors are field reversible when shipped KD.

SILL PANS

Molded ABS plastic sill pan system is recommended for use in all patio door installations. The JELD-WEN Premium Wood 300 Series sill pan must be specified when ordering and is field-installed prior to patio door placement.

INSTALLATION

Installation per JELD-WEN Installation Method for Metal Clad Patio Doors JII005 or JII014. See www.jeld-wen.com/resources for instructions.

PERFORMANCE

NFRC Certified - (Rated and labeled in accordance with NFRC)

WDMA Hallmark Certified -
In accordance with **AAMA/NWWDA/101/I.S.2-97**

PRODUCT SPECIFICATIONS: 400 SERIES SLIDING PATIO DOOR**EXTERIOR FINISH**

Exterior aluminum surfaces are low maintenance extruded aluminum coated with a thermo set polyester finish that meets or exceeds the AAMA 2603 performance standards. Standard colors include Brilliant White, Chestnut Bronze, Desert Sand, French Vanilla, Hartford Green, Mesa Red, Black, Arctic Silver and Dark Chocolate.

AURALAST® WOOD

AuraLast® wood is fundamentally different from wood resulting from traditional millwork preservation processes in that it uses a proprietary vacuum/pressure process to provide protection throughout the wood parts used to make windows and doors. AuraLast® wood is distinguished from wood using the current preservation methods by its unique ability to achieve greater penetration of the active ingredients into the wood parts, with a penetration of the treatment being a minimum of 92%.

INTERIOR FINISH

All interior surfaces are unfinished clear pine ready for on site finishing. Primed and pre-finished interiors are available in paint: Pure White, Extra White, Natural Choice, Moderate White; in stain: Wheat, Cherry, Cordovan; and Clear Lacquer.

FRAME

Frame is assembled from select kiln dried pine using AuraLast® wood on all exterior parts. Exterior surface of head and side jambs are covered with .050 (1.27mm) extruded aluminum cladding; corner joints are sealed with silicone and reinforced with a metal corner key and screw boss. Frames are finger jointed with an option for clear on most sizes. Frame thickness is 1-7/32" (31 mm) at head and side jamb and 11/16" (17.5mm) at sill. Basic jamb width is 4-9/16" (116mm) and may be extended for different wall depths. Integral nailing fin is part of head and side extrusion. Sill is constructed of a dark bronze one-piece pulltruded fiberglass and a bronze anodized aluminum track. An integral wrapped foam sill weather-strip provides continuous seal against water and air infiltration. Two panel and four panel (quad) doors have continuous head and sill. Three panel units have separate sidelight field muller to two-panel unit. Doors are shipped KD but factory assembly may be specified on most sizes as an option. Exterior of frame extrusion is grooved to accept accessories.

PANEL

Panel is 1-23/32" (43.7mm) thick select kiln-dried pine using AuraLast® wood and engineered wood substrate, which is water repellent preservative treated. Selected panel members have Timberstrand core for added strength and dimensional stability. Wood stiles and top rail are 4-9/16" (116mm) in face width and bottom rail is 5-5/16" (135mm) in face width on 6'8" height and 8-5/16" (211mm) on 6'11" and 8'0" heights. Panels are machine clamped to insure accurate squaring of the panel and joined with coped corners secured with multiple hardwood dowel pins. Exterior surfaces are covered with .050 (13mm) extruded aluminum with cope jointed and sealed corners. Operating door panel slides on inside track. Quad doors have two stationary and two operating panels with a center astragal applied to the secondary active panel. The primary active panel is the left center panel on quad doors (viewed from the building exterior) unless otherwise specified.

GLAZING

3/4" (19mm) thick sealed insulating glass is constructed from two panes of tempered glass, utilizing a continuous roll formed stainless steel spacer with dual seal sealant. A computer-controlled application of clear silicone is used to bed the exterior of the insulating glass into the panel. An acrylic sealant is used to bed the interior. All insulating glass units comply with the performance requirements of IGCC in accordance with either ASTM E774 or E2190.

GLAZING OPTIONS

3/4" insulating glass available in Low-E with Argon, Low-E, Low-E 366, Clear, Neat Glass, reflective, tinted, or obscure, tempered or other specialty glass as specified. Preserve® film is a 0.003" thick polyethylene film with a low tack acrylic adhesive applied to the glass for protection during shipping and installation. 4,000 foot elevations and higher require a capillary tube to equalize environmental stress (otherwise known as High Altitude glazing). High Altitude glazing does not allow the use of Argon as listed under glazing options.

WEATHER-STRIPPING

Engineered system combines a rigid vinyl parting stop weather-strip with flexible leaves at the head and side jambs. A rigid vinyl interlock is applied to the meeting stiles of both the operating and stationary panels and sealed with a thermoplastic weather-strip. The sill track incorporates a wrapped foam weather-strip which contact the bottom edge of the operating panel as well as the dense pile dust plug at the bottom of the meeting stiles. The stationary panel setting block incorporates dual durometer vinyl weather-strips. The operating panel is guided by a rigid vinyl track at the head jamb. All weather-strips except sill are Ivory colored.

HARDWARE

Operating panel rides on two sets of adjustable, tandem, steel ball bearing rollers. Standard handle incorporates a positive locking mechanism with adjustable throw latch and oak interior hand pull. Quad door includes dummy handle. Doors come with a brown finished wood interior handle with black exterior hand pull. Handle set is also available in Bright Brass, Antique Brass, Polished Chrome, Brushed Chrome, Powder Coat White, or Oil Rubbed Bronze finish. Optional lock cylinders are keyed Weiser and may be re-keyed locally to match other doors. Optional multi-point lock is available with solid brass handle in Bright Brass, Antique Brass, or Brushed Chrome finish. Lock cylinder for multi-point lock is standard with Schlage "C" keyway.

EXTERIOR INSECT SCREENS

Charcoal fiberglass screen cloth (18x16 mesh) with clad color matched .040" (1mm) extruded aluminum frame. Door screen rides on a set of two adjustable steel rollers at both top and bottom of the screen and operates on outside track. Quad doors have two screens with field-applied astragal. Insect screens are intended to allow air and light in and to keep insects out. They are not intended to keep anyone or anything from falling through an open door. For safety screens or other security devices contact your local building supply retailer.

GRILLES

SDL (Simulated Divided Lites) - extruded aluminum muntins permanently applied to the exterior of the insulating glass unit (not available on textured glass) in 7/8" (22mm), 1-1/8" (28.5mm), or 1-3/8" (34.9mm) widths. SDL is standard with a light bronze internal shadow bar to give a true divided lite appearance. As an option, SDL may be ordered with a silver shadow bar. Clear wood interior muntin bars match the exterior muntin width and are permanently bonded to the interior of the glass. Also available is a 2-5/16" (59mm) SDL bar, which simulates a double-hung checkrail.

Full Surround Wood Grilles - Rectangular unfinished clear pine wood grilles in 7/8" (22mm) are available in patterns selected by the owner.

GBG (Grilles between the Glass) - 5/8" (15.9mm) flat and 23/32" or 1" contour mounted between the glass panes suspended within the air cavity.

Continued on next page

PRODUCT SPECIFICATIONS: 400 SERIES SLIDING PATIO DOOR

EXTERIOR TRIM

1-5/8" (41mm) wide aluminum brickmould with an integral nailing fin is available factory applied. Also available is 3-1/2" (88.5mm) flat or Adams casing with an integral nailing fin. 1-1/2" retrofit brickmould casing is available as well. All of the accessories are .050" (1.3mm) extruded aluminum. Two sizes of frame expander, 1-7/8" (48mm) and 3-1/4" (83mm) may be used alone or in conjunction with a 2-1/8" (54mm) mull expander. Standard 5/16" (8mm) clad mull cover used for joining doors together. Color and finish match exterior finish specs above.

EXTENSION JAMBS

Extension jambs are shipped loose on KD doors. Extensions are applied to the interior of head and sides of the frame and are 21/32" (16.7mm) thick pine to accommodate wall depths up to 9-5/16" with one piece, and up to 12" with two pieces.

HANDING

Operation should be specified as left or right as viewed from building exterior. 400 Series patio doors are not field reversible.

SILL PANS

Molded ABS plastic sill pan system is recommended for use in all patio door installations. The JELD-WEN Premium Wood 400 Series sill pan must be specified when ordering and is field-installed prior to patio door placement.

INSTALLATION

Installation per JELD-WEN Installation Method for Metal Clad Patio Doors JII005 or JII014. See www.jeld-wen.com/resources for instructions.

PERFORMANCE

NFRC Certified - (Rated and labeled in accordance with NFRC)

WDMA Hallmark Certified -
In accordance with **AAMA/NWWDA/101/1.S.2-97**

QUICK SPEC GUIDE: 300 SERIES SLIDING PATIO DOOR

SPECIFICATION	STANDARD FEATURES	OPTIONAL FEATURES
FRAME	<ul style="list-style-type: none"> Fingerjoint Wood 	<ul style="list-style-type: none"> Clear available on most sizes
EXTERIOR FINISH	<ul style="list-style-type: none"> Brilliant White Chestnut Bronze Desert Sand French Vanilla Mesa Red Hartford Green Black Arctic Silver Dark Chocolate 	
EXTERIOR TRIM	<ul style="list-style-type: none"> Nailing Fin Drip Cap 	<ul style="list-style-type: none"> Aluminum 1-5/8" Brickmould with integral nailing fin Aluminum 1-1/2" Retrofit Brickmould 3-1/2" Flat Casing with integral nailing fin Adams Clad Brickmould with integral nailing fin
INTERIOR FINISH	<ul style="list-style-type: none"> Natural 	<ul style="list-style-type: none"> Priming Available <p>Pre-finished Interior Options are:</p> <ul style="list-style-type: none"> Paint - Pure White, Extra White, Natural Choice, Moderate White Stain - Wheat, Fruitwood, Cherry, Cordovan Clear Lacquer
SIZE	<ul style="list-style-type: none"> Width: <ul style="list-style-type: none"> Two Panel: 5-0, 6-0, 8-0 (Std) Four Panel: 10-0, 12-0, 16-0 Sidelight Width: 2-6, 3-0, 4-0 Height: <ul style="list-style-type: none"> 6-8, 6-11, 8-0 	<ul style="list-style-type: none"> Minimum Width: 5-0 Maximum Width: 8-0 Minimum Width: 9-0 Maximum Width: 16-0 Minimum Width: 1-5 Maximum Width: 4-0 Minimum Height: 2-0 Maximum Height: 8-0
GLAZING	<ul style="list-style-type: none"> Tempered Low-E Insulating Glass Preserve® Protective Film 	<ul style="list-style-type: none"> Clear Obscure Bronze Low-E 366 Neat Glass Reflective Tempered
		<ul style="list-style-type: none"> High Altitude
GRILLES		<ul style="list-style-type: none"> 5/8" Flat, 23/32" or 1" Contour GBG 7/8" Full Surround Wood Grilles <p>SDL Bead Profile:</p> <ul style="list-style-type: none"> 7/8", 1-1/8", 1-3/8", 2-5/16" with Light Bronze Shadow Bar 7/8", 1-1/8", 1-3/8", 2-5/16" with Silver Shadow Bar
HARDWARE	<ul style="list-style-type: none"> Single Point Lock 	<ul style="list-style-type: none"> Multi Point Available

Continued on next page

QUICK SPEC GUIDE: 300 SERIES SLIDING PATIO DOOR

SPECIFICATION	STANDARD FEATURES	OPTIONAL FEATURES <i>Some options may require additional lead times. Consult your JELD-WEN Sales Representative.</i>
HANDLE SET	<ul style="list-style-type: none"> Doors come with a single point brown finished wood interior handle with black exterior hand pull. 	<ul style="list-style-type: none"> Optional lock cylinders keyed Schlage & may be re-keyed. Single Point Legacy Handle set is also available in Polished Brass, Antique Brass, Polished Chrome, Brushed Chrome, Powder Coat White or Oil Rubbed Bronze finish. Optional foot-activated security lock. Optional multi-point lock is available with solid brass handle in Polished Brass, Antique Brass, Brushed Chrome or Oil Rubbed Bronze finish.
SILL	<ul style="list-style-type: none"> Dark bronze one-piece pultruded fiberglass and oak threshold 	<ul style="list-style-type: none"> Sill Pan Available
HANDING	<ul style="list-style-type: none"> Viewed from the outside Door Ships KD on 2-Panel and Quad doors 3-Panel doors and sidelights will ship Factory Setup 	<ul style="list-style-type: none"> Door Factory Assembly Available on 2-Panel doors
JAMB	<ul style="list-style-type: none"> 4-9/16" 	<ul style="list-style-type: none"> Minimum: 4-9/16" Maximum: 9-5/16" (one piece) Loose Maximum: 12" (two piece) Loose
SCREENS	<ul style="list-style-type: none"> Fiberglass Extruded Aluminum Frame 	
SCREEN FRAME COLOR	<ul style="list-style-type: none"> Brilliant White Chestnut Bronze Desert Sand French Vanilla Mesa Red Hartford Green Black Arctic Silver Dark Chocolate 	

QUICK SPEC GUIDE: 400 SERIES SLIDING PATIO DOOR

SPECIFICATION	STANDARD FEATURES	OPTIONAL FEATURES <i>Some options may require additional lead times. Consult your JELD-WEN Sales Representative.</i>
FRAME	<ul style="list-style-type: none"> Fingerjoint Wood 	<ul style="list-style-type: none"> Clear available on most sizes
EXTERIOR FINISH	<ul style="list-style-type: none"> Brilliant White Chestnut Bronze Desert Sand French Vanilla Mesa Red Hartford Green Black Arctic Silver Dark Chocolate 	
EXTERIOR TRIM	<ul style="list-style-type: none"> Nailing Fin Drip Cap 	<ul style="list-style-type: none"> Aluminum 1-5/8" Brickmould with integral nailing fin Aluminum 1-1/2" Retrofit Brickmould 3-1/2" Flat Casing with integral nailing fin Adams Clad Brickmould with integral nailing fin
INTERIOR FINISH	<ul style="list-style-type: none"> Natural 	<ul style="list-style-type: none"> Priming Available Pre-finished Interior Options are: <ul style="list-style-type: none"> Paint - Pure White, Extra White, Natural Choice, Moderate White Stain - Wheat, Fruitwood, Cherry, Cordovan Clear Lacquer
SIZE	<ul style="list-style-type: none"> Width: <ul style="list-style-type: none"> Two Panel: 5-0, 6-0, 8-0 (Std) Four Panel: 10-0, 12-0, 16-0 Sidelight Width: 2-6, 3-0, 4-0 Height: <ul style="list-style-type: none"> 6-8, 6-11, 8-0 	<ul style="list-style-type: none"> Minimum Width: 5-0 Maximum Width: 8-0 Minimum Width: 9-0 Maximum Width: 16-0 Minimum Width: 1-5 Maximum Width: 4-0 Minimum Height: 2-0 Maximum Height: 8-0
GLAZING	<ul style="list-style-type: none"> Tempered Low-E Insulating Glass Preserve® Protective Film 	<ul style="list-style-type: none"> Clear Obscure Bronze Low-E 366 Neat Glass Reflective Tempered
		<ul style="list-style-type: none"> High Altitude
GRILLES		<ul style="list-style-type: none"> 5/8" Flat, 23/32" or 1" Contour GBG 7/8" Full Surround Wood Grilles SDL Bead Profile: <ul style="list-style-type: none"> 7/8", 1-1/8", 1-3/8", 2-5/16" with Light Bronze Shadow Bar 7/8", 1-1/8", 1-3/8", 2-5/16" with Silver Shadow Bar
HARDWARE	<ul style="list-style-type: none"> Single Point Lock 	<ul style="list-style-type: none"> Multi Point Available

Continued on next page

QUICK SPEC GUIDE: 400 SERIES SLIDING PATIO DOOR

SPECIFICATION	STANDARD FEATURES	OPTIONAL FEATURES <i>Some options may require additional lead times. Consult your JELD-WEN Sales Representative.</i>
HANDLE SET	<ul style="list-style-type: none"> Doors come with a single point brown finished wood interior handle with black exterior hand pull. 	<ul style="list-style-type: none"> Optional lock cylinders keyed Schlage & may be re-keyed. Single Point Legacy Handle set is also available in Polished Brass, Antique Brass, Polished Chrome, Brushed Chrome, Powder Coat White or Oil Rubbed Bronze finish. Optional foot-activated security lock. Optional multi-point lock is available with solid brass handle in Polished Brass, Antique Brass, Brushed Chrome or Oil Rubbed Bronze finish.
SILL	<ul style="list-style-type: none"> Dark bronze one-piece pultruded fiberglass and bronze anodized aluminum track 	<ul style="list-style-type: none"> Sill Pan Available
HANDING	<ul style="list-style-type: none"> Viewed from the outside Door Ships KD on 2-Panel and Quad doors 3-Panel doors and sidelights will ship Factory Setup 	<ul style="list-style-type: none"> Door Factory Assembly Available on 2-Panel doors
JAMB	<ul style="list-style-type: none"> 4-9/16" 	<ul style="list-style-type: none"> Minimum: 4-9/16" Maximum: 9-5/16" (one piece) Loose Maximum: 12" (two piece) Loose
SCREENS	<ul style="list-style-type: none"> Fiberglass Extruded Aluminum Frame 	
SCREEN FRAME COLOR	<ul style="list-style-type: none"> Brilliant White Chestnut Bronze Desert Sand French Vanilla Mesa Red Hartford Green Black Arctic Silver Dark Chocolate 	

HANDING CODES

300 AND 400 SERIES

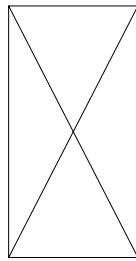

STAT ONLY

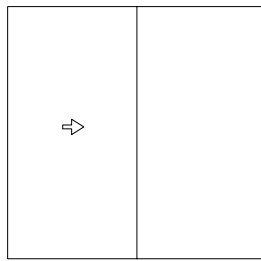

ACTIVE STAT
SL-1

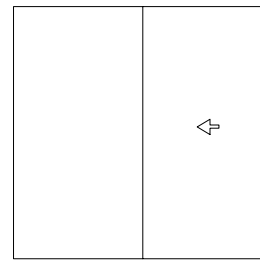

STAT ACTIVE
SL-2

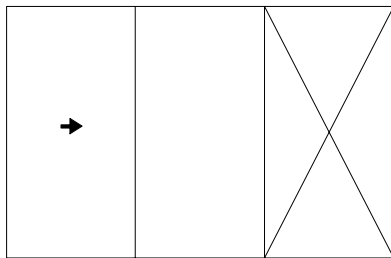

ACTIVE STAT SIDE
SL-3

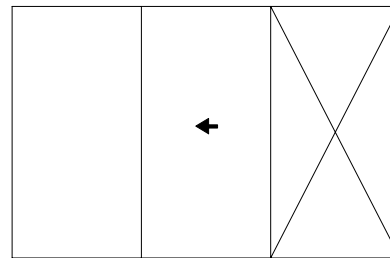

STAT ACTIVE SIDE
SL-4

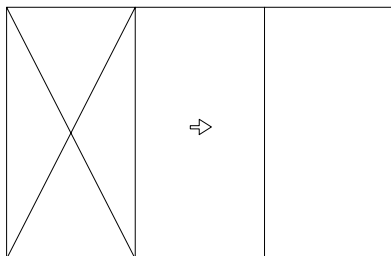

SIDE ACTIVE STAT
SL-5

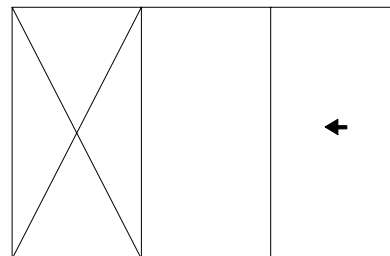

SIDE STAT ACTIVE
SL-6

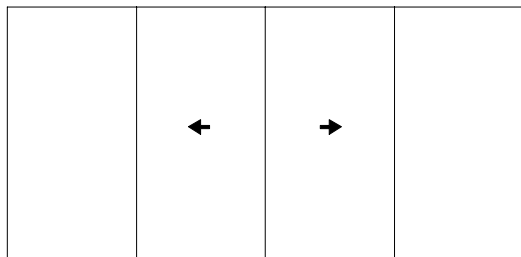

STAT PRIMARY SECND STAT
SL-7

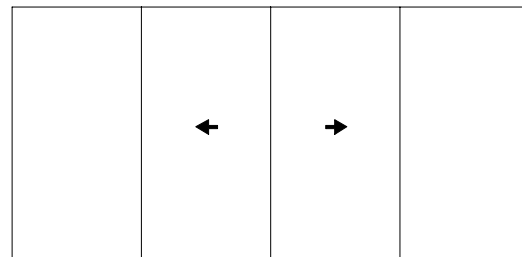

STAT SECND PRIMARY STAT
SL-8

Note: Doors pictured as viewed from the exterior.

GENERAL INFORMATION

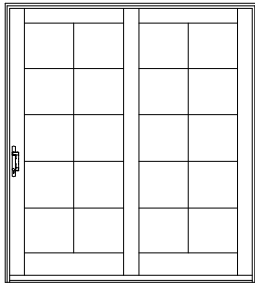

RIGHT STATIONARY

DIMENSIONAL DOORS

Clad Sliding patio doors may be specified as "dimensional", by adjusting the desired rough opening width or height in 1/4" increments from standard.

Clad Sliding patio doors are available in single, twin, triple and quad panel doors.

OPERATION

Clad Sliding patio doors are available in a full range of operating and stationary styles. Single panel doors are only available as stationary (non-venting) styles. Two-panel doors are available with left or right operation. Three-panel doors are available with left and right operation and with center or end operators. Four-panel doors are available with two panels operating from the center. Configuration and handing is based on viewing the door from the exterior.

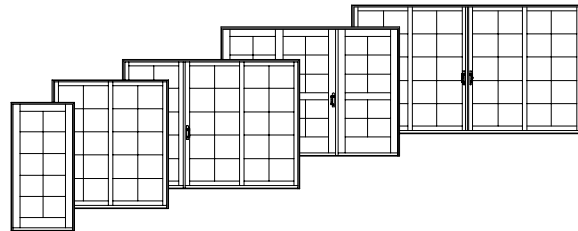

MULTIPLE ASSEMBLIES

Clad Sliding patio doors are available in a wide variety of multiple panel configurations from the factory, all of which are assembled with continuous sills. Mulling of Clad Sliding patio doors to like products in the field is not recommended. Instead, individual factory assembled units should be installed in contiguous rough openings, in order to provide adequate framing support to assure the best performance of the door systems.

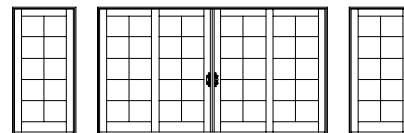
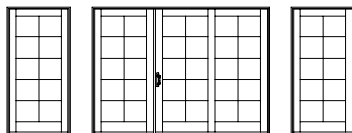
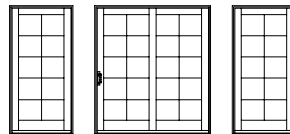

ELEVATION NOTES

ELEVATION DRAWINGS UTILIZE A LIMITED NUMBER OF PROJECTED LINES TO PRODUCE A RUDIMENTARY DRAWING INTENDED TO BE USED IN A SM GRAPHICAL SCALE. ELEVATIONS ARE VIEWED PERPENDICULAR FROM THE EXTERIOR OF THE STRUCTURE. IF MORE DIMENSIONS ARE NEEDED, USE SECTION DRAWINGS FOR MORE COMPLETE DEPICTIONS.

UNIT	2'-8 3/4"
RO	2'-9 1/2"
FRAME	2'-8 3/4"
GLASS	24 5/8"

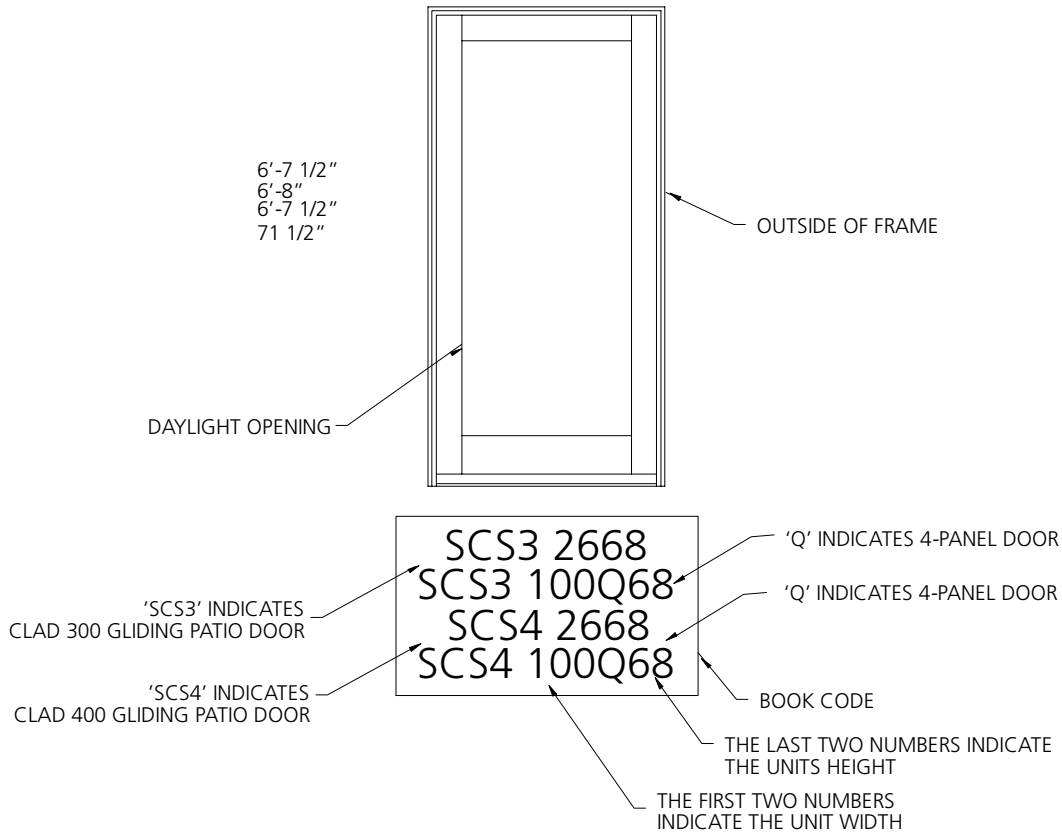

GENERAL GLIDING DOOR NOTES

1. CLAD SLIDING PATIO DOOR UNITS ARE AVAILABLE AS OPERATING OR FIXED UNITS.
2. UNIT ELEVATIONS ARE SHOWN WITHOUT EXTERIOR TRIM. UNIT SIZES & MASONRY OPENING DIMENSIONS WILL CHANGE WITH THE ADDITION OF EXTERIOR TRIM. SEE THE 'UNIT SIZING, ROUGH OPENINGS & MASONRY OPENINGS' PAGE FOR EXTERIOR TRIM EFFECTS.
3. OPERATING UNITS ARE AVAILABLE AS LEFT OR RIGHT HAND OPERATION.
4. INTERMEDIATE LOCKRAILS, RAISED PANELS AND 10 1/4" BOTTOM RAILS ARE AVAILABLE ON ALL WIDE STYLE UNITS.

300 SERIES SLIDING PATIO DOOR

UNIT
RO
FRAME
GLASS

2'-8 3/4"
2'-9 1/2"
2'-8 3/4"
24 5/8"

5'-0"
5'-0 3/4"
5'-0"
24 5/8"

7'-8 3/4"
7'-9 1/2"
7'-8 3/4"
24 5/8"

6'-7 1/2"
6'-8"
6'-7 1/2"
71 1/2"

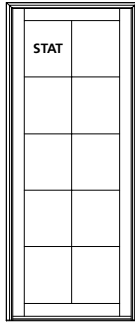

SCS3 2668

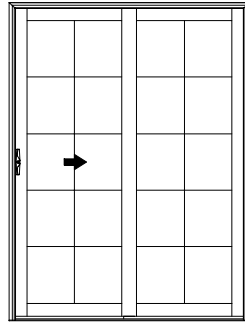

SCS3 5068

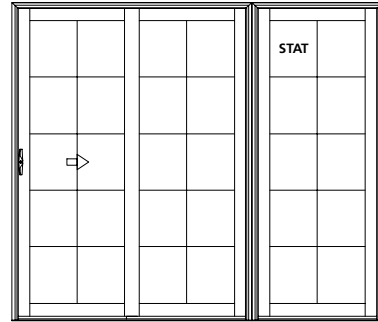

SCS3 7668

6'-10 1/2"
6'-11"
6'-10 1/2"
74 1/2"

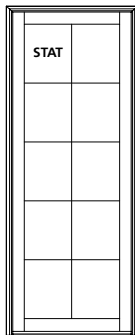

SCS3 26611

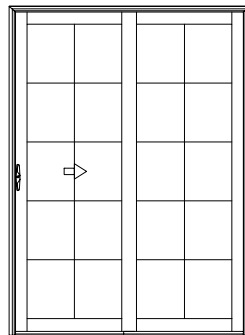

SCS3 50611

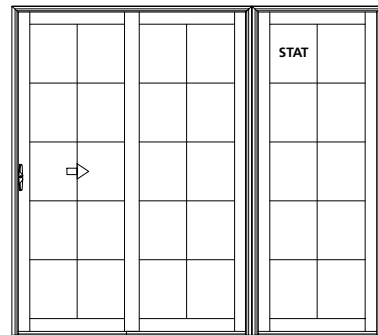

SCS3 76611

7'-11 1/2"
8'-0"
7'-11 1/2"
87 1/2"

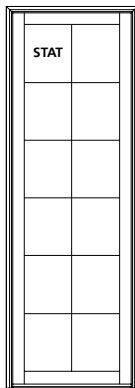

SCS3 2680

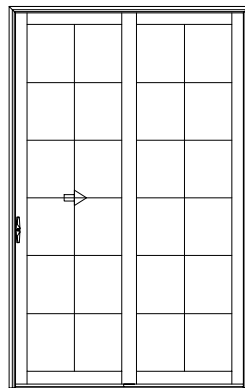

SCS3 5080

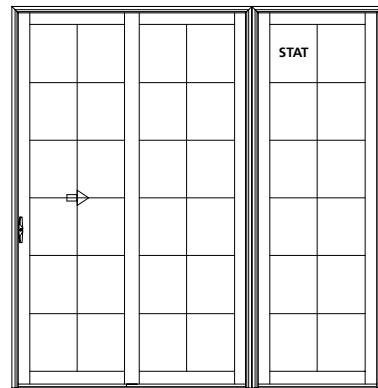

SCS3 7680

***Note:** See page 15-10 to specify handing.
6-8 and 6-11 300 Series doors are field reversible when shipped KD.

SCALE 1/4" = 1'

300 SERIES SLIDING PATIO DOOR

UNIT
RO
FRAME
GLASS

3'-2 3/4"
3'-3 1/2"
3'-2 3/4"
30 5/8"

6'-0"
6'-0 3/4"
6'-0"
30 5/8"

9'-2 3/4"
9'-3 1/2"
9'-2 3/4"
30 5/8"

6'-7 1/2"
6'-8"
6'-7 1/2"
71 1/2"

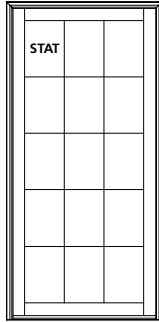

SCS3 3068

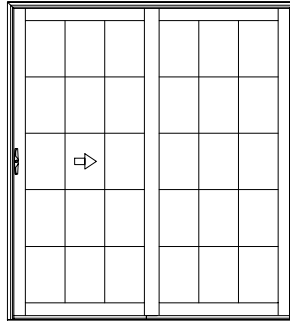

SCS3 6068

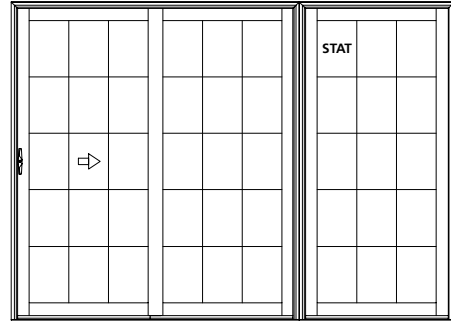

SCS3 9068

6'-10 1/2"
6'-11"
6'-10 1/2"
74 1/2"

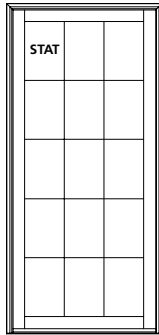

SCS3 30611

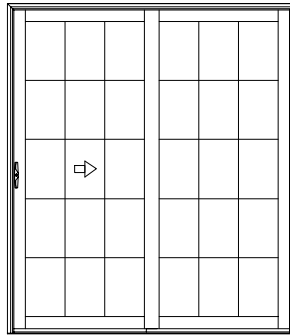

SCS3 60611

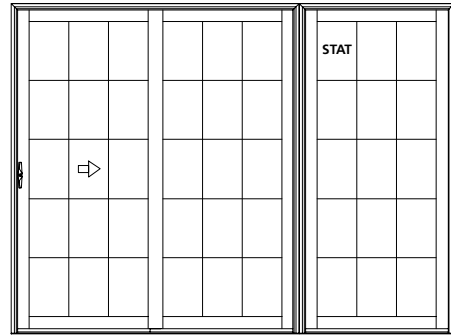

SCS3 90611

7'-11 1/2"
8'-0"
7'-11 1/2"
87 1/2"

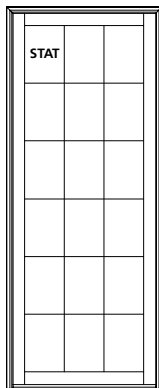

SCS3 3080

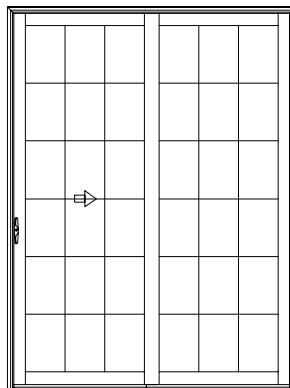

SCS3 6080

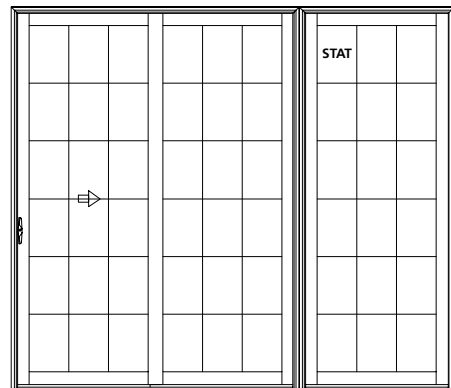

SCS3 9080

***Note:** See page 15-10 to specify handing.
6-8 and 6-11 300 Series doors are field reversible when shipped KD.

SCALE 1/4" = 1'

300 SERIES SLIDING PATIO DOOR

UNIT
RO
FRAME
GLASS

4'-2 3/4"
4'-3 1/2"
4'-2 3/4"
42 5/8"

8'-0"
8'-0 3/4"
8'-0"
42 5/8"

12'-2 3/4"
12'-3 1/2"
12'-2 3/4"
42 5/8"

6'-7 1/2"
6'-8"
6'-7 1/2"
71 1/2"

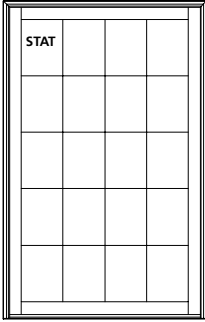

SCS3 4068

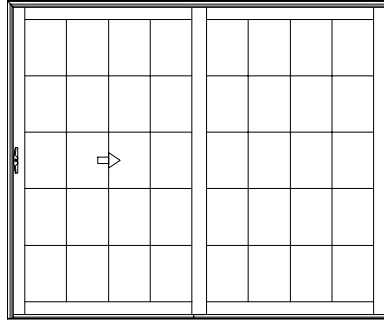

SCS3 8068

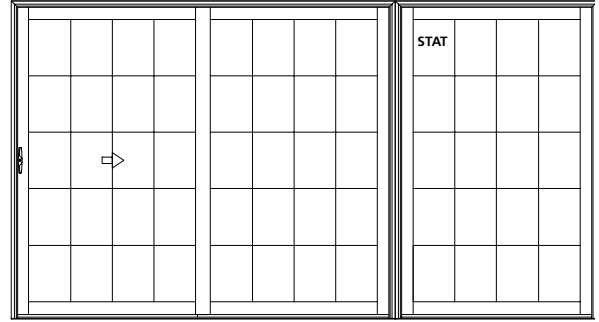

SCS3 12068

6'-10 1/2"
6'-11"
6'-10 1/2"
74 1/2"

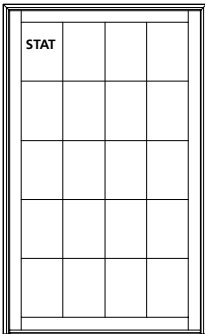

SCS3 40611

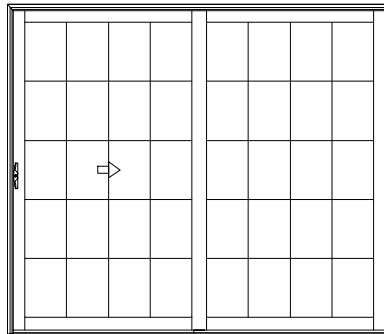

SCS3 80611

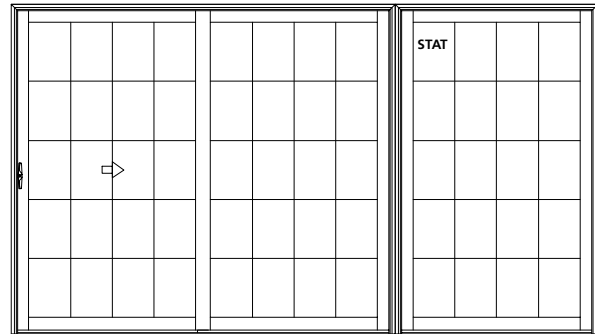

SCS3 120611

7'-11 1/2"
8'-0"
7'-11 1/2"
87 1/2"

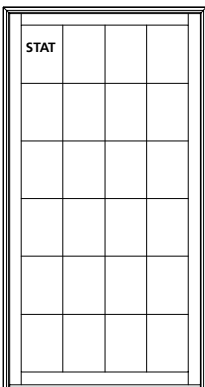

SCS3 4080

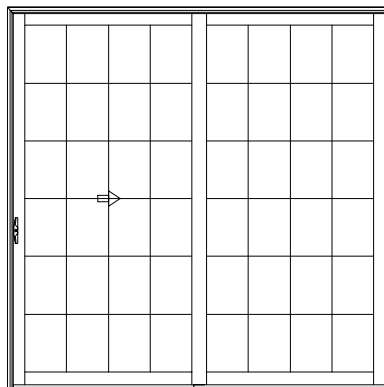

SCS3 8080

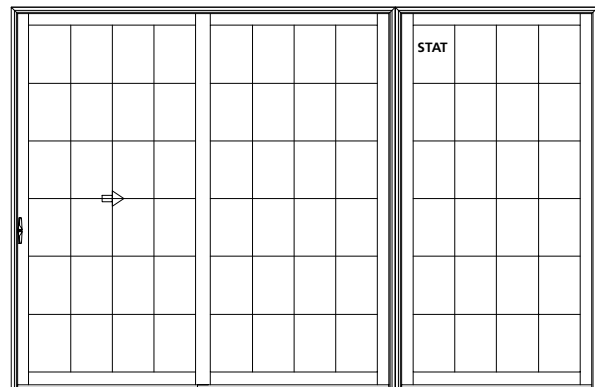

SCS3 12080

***Note:** See page 15-10 to specify handing.
6-8 and 6-11 300 Series doors are field reversible when shipped KD.

SCALE 1/4" = 1'

300 SERIES 4-PANEL SLIDING PATIO DOOR

UNIT
RO
FRAME
GLASS

9'-10"
9'-10 3/4"
9'-10"
24 5/8"

11'-10"
11'-10 3/4"
11'-10"
30 5/8"

6'-7 1/2"
6'-8"
6'-7 1/2"
71 1/2"

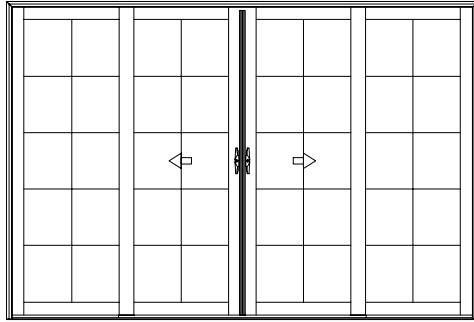

SCS3 100Q68

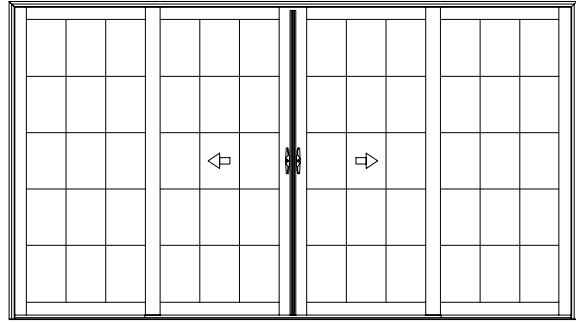

SCS3 120Q68

6'-10 1/2"
6'-11"
6'-10 1/2"
74 1/2"

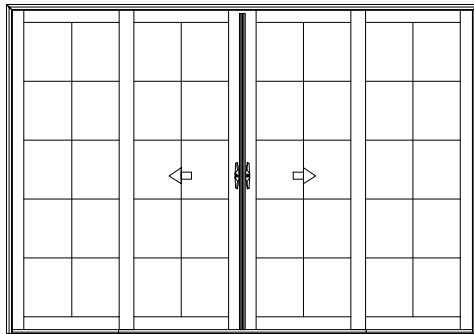

SCS3 100Q611

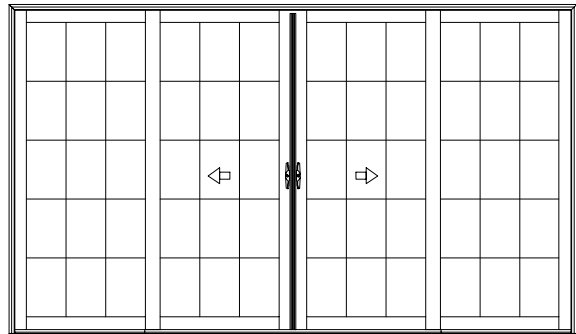

SCS3 120Q611

7'-11 1/2"
8'-0"
7'-11 1/2"
87 1/2"

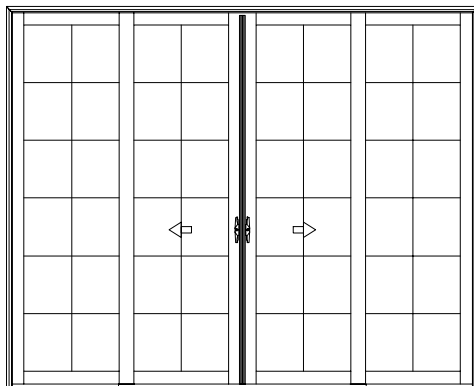

SCS3 100Q80

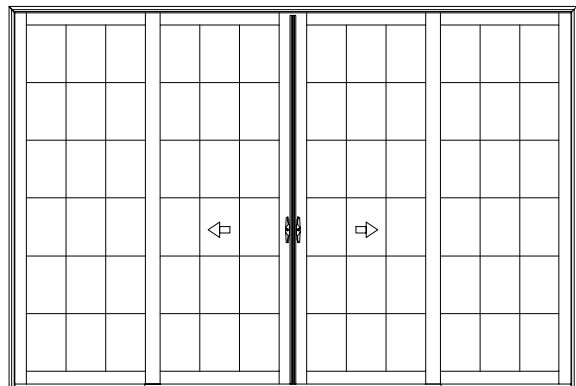

SCS3 120Q80

***Note:** See page 15-10 to specify handing.
4-Panel doors are not field reversible.

SCALE 1/4" = 1'

300 SERIES 4-PANEL SLIDING PATIO DOOR

UNIT	15'-10"
RO	15'-10 3/4"
FRAME	15'-10"
GLASS	42 5/8"

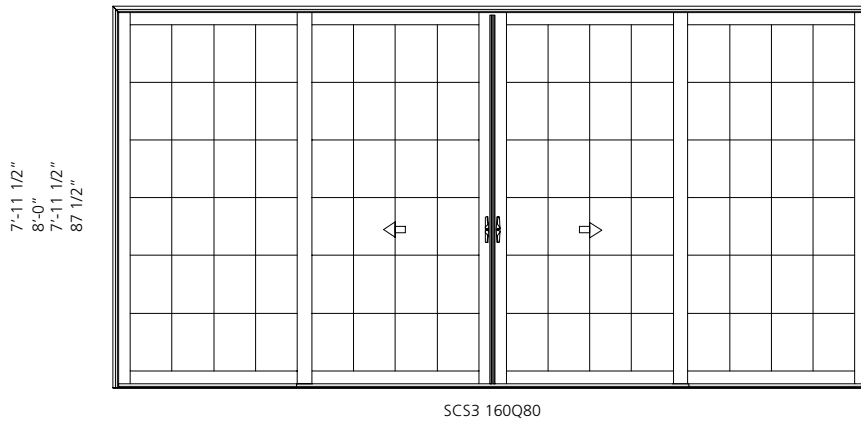
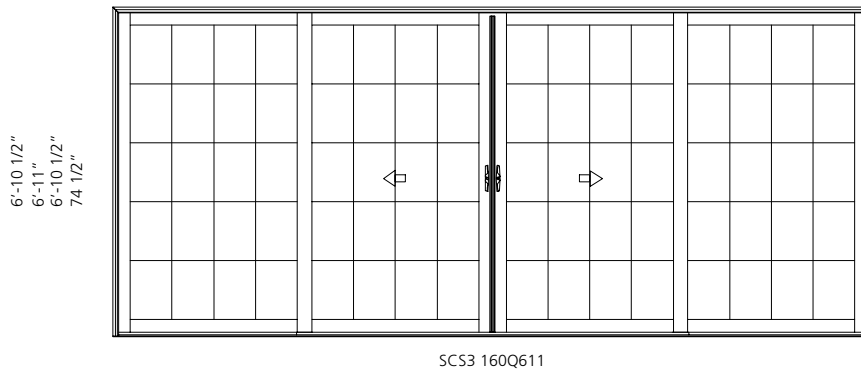
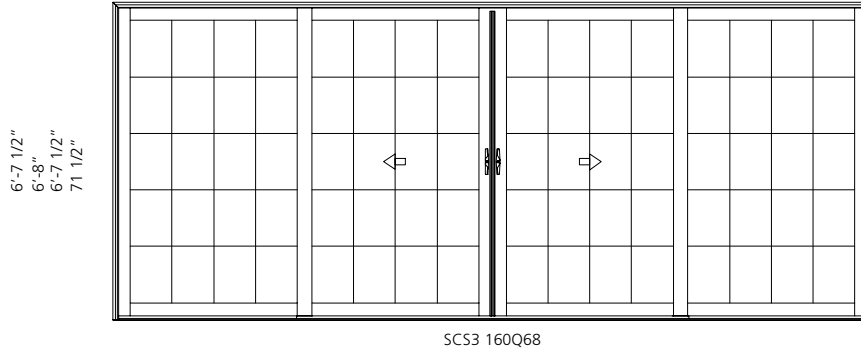

***Note:** See page 15-10 to specify handing.
4-Panel doors are not field reversible.

SCALE 1/4" = 1'

300 SERIES TRANSOM ALIGNMENT GUIDE

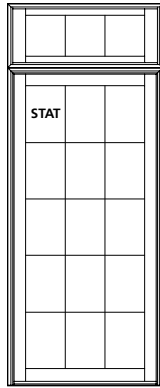

ONE PANEL TRANSOM

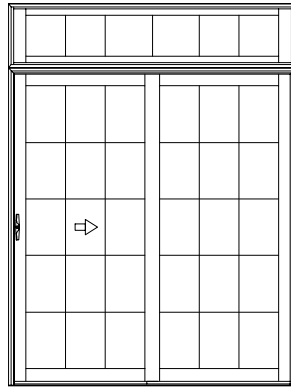

ONE PANEL TRANSOM

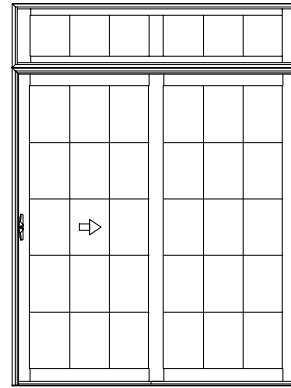

ONE PANEL (2-LITE) TRANSOM

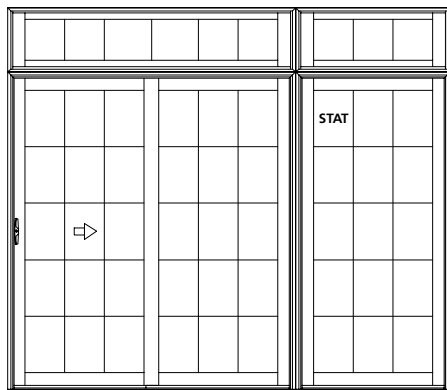

ONE PANEL TRANSOM

ONE PANEL TRANSOM

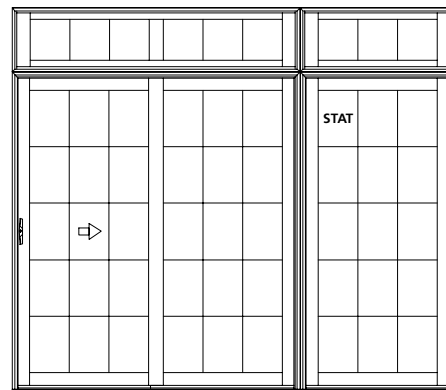

ONE PANEL (2-LITE) TRANSOM

ONE PANEL TRANSOM

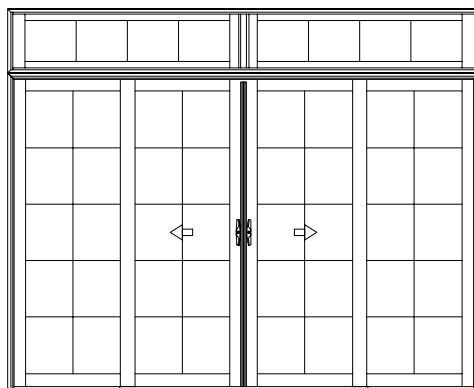



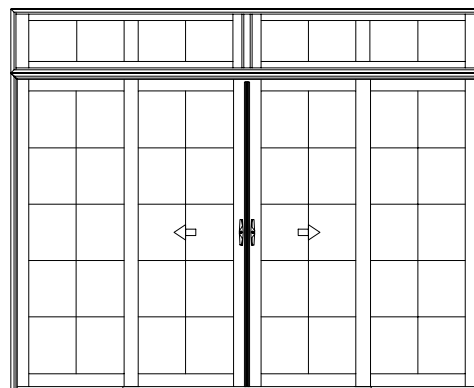







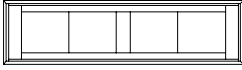
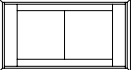
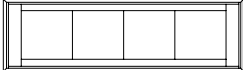
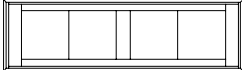







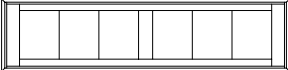

QUAD 2-PANEL TRANSOM
AVAILABLE ON 10-0 & 12-0 WIDTHS ONLY

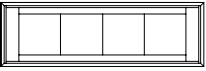
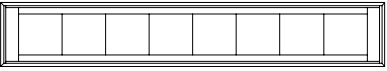
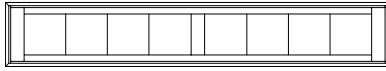

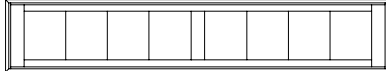
QUAD 2-PANEL (4-LITE) TRANSOM
(WILL ALIGN WITH INTERLOCKS ON QUAD DOOR)
AVAILABLE ON 10-0 & 12-0 WIDTHS ONLY

300 SERIES SLIDING DOOR TRANSOM

	ONE PANEL TRANSOM	ONE PANEL TRANSOM	ONE PANEL (2-LITE) TRANSOM*
UNIT	2'-8 3/4"	5'-0"	5'-0"
RO	2'-9 1/2"	5'-0 3/4"	5'-0 3/4"
FRAME	2'-8 3/4"	5'-0"	5'-0"
GLASS	24 5/8"	52 1/16"	24 5/8"
1'-4" 1'-4 1/2" 1'-4" 11 1/16"			
	SCS3 2614-1	SCS3 5014-1	SCS3 5014-2
1'-6" 1'-6 1/2" 1'-6" 13 1/16"			
	SCS3 2616-1	SCS3 5016-1	SCS3 5016-2
2'-0" 2'-0 1/2" 2'-0" 19 1/16"			
	SCS3 2620-1	SCS3 5020-1	SCS3 5020-2
UNIT	3'-2 3/4"	6'-0"	6'-0"
RO	3'-3 1/2"	6'-0 3/4"	6'-0 3/4"
FRAME	3'-2 3/4"	6'-0"	6'-0"
GLASS	30 5/8"	64 1/16"	30 5/8"
1'-4" 1'-4 1/2" 1'-4" 11 1/16"			
	SCS3 3014-1	SCS3 6014-1	SCS3 6014-2
1'-6" 1'-6 1/2" 1'-6" 13 1/16"			
	SCS3 3016-1	SCS3 6016-1	SCS3 6016-2
2'-0" 2'-0 1/2" 2'-0" 19 1/16"			
	SCS3 3020-1	SCS3 6020-1	SCS3 6020-2
UNIT	4'-2 3/4"	8'-0"	8'-0"
RO	4'-3 1/2"	8'-0 3/4"	8'-0 3/4"
FRAME	4'-2 3/4"	8'-0"	8'-0"
GLASS	42 5/8"	88 1/16"	42 5/8"
1'-4" 1'-4 1/2" 1'-4" 11 1/16"			
	SCS3 4014-1	SCS3 8014-1	SCS3 8014-2
1'-6" 1'-6 1/2" 1'-6" 13 1/16"			
	SCS3 4016-1	SCS3 8016-1	SCS3 8016-2
2'-0" 2'-0 1/2" 2'-0" 19 1/16"			
	SCS3 4020-1	SCS3 8020-1	SCS3 8020-2

*Note: See Horizontal Section on page 15-50 for post detail.

SCALE 1/4" = 1'

300 SERIES SLIDING DOOR TRANSOM

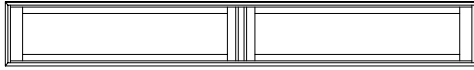

QUAD 2-PANEL TRANSOM

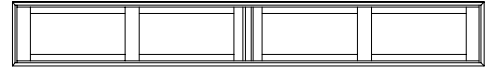

QUAD 2-PANEL (4-LITE) TRANSOM*
(WILL ALIGN WITH INTERLOCKS ON QUAD DOOR)

UNIT
RO
FRAME
GLASS

9'-10"
9'-10 3/4"
9'-10"
52 1/16"

9'-10"
9'-10 3/4"
9'-10"
24 5/8"

1'-4"
1'-4 1/2"
1'-4"
11 1/16"

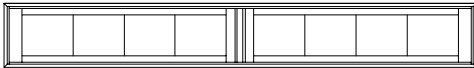

SCS3 10014-2

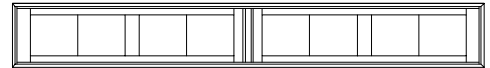

SCS3 10014-4

1'-6"
1'-6 1/2"
1'-6"
13 1/16"

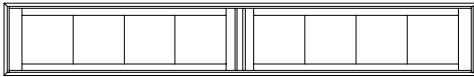

SCS3 10016-2

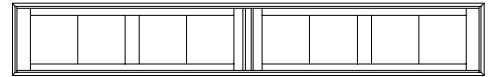

SCS3 10016-4

2'-0"
2'-0 1/2"
2'-0"
19 1/16"

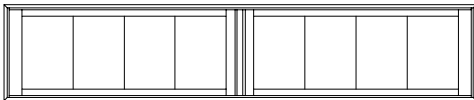

SCS3 10020-2

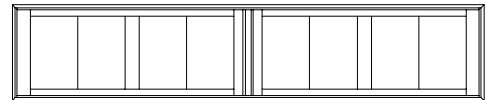

SCS3 10020-4

UNIT
RO
FRAME
GLASS

11'-10"
11'-10 3/4"
11'-10"
64 1/16"

11'-10"
11'-10 3/4"
11'-10"
30 5/8"

1'-4"
1'-4 1/2"
1'-4"
11 1/16"

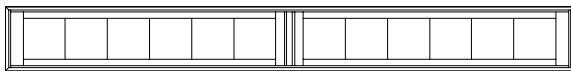

SCS3 12014-2

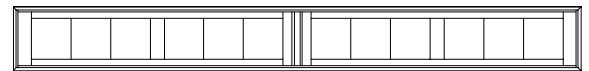

SCS3 12014-4

1'-6"
1'-6 1/2"
1'-6"
13 1/16"

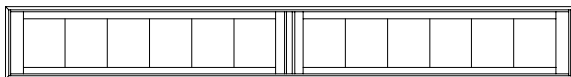

SCS3 12016-2

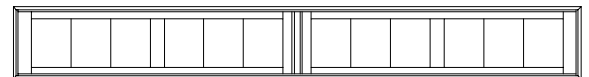

SCS3 12016-4

2'-0"
2'-0 1/2"
2'-0"
19 1/16"

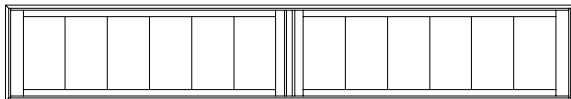

SCS3 12020-2

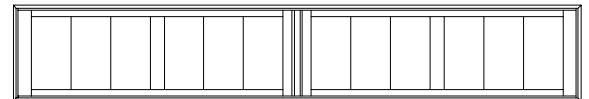

SCS3 12020-4

*Note: See 3" Horizontal Section on page 15-50 for post detail.

SCALE 1/4" = 1'

400 SERIES SLIDING PATIO DOOR

UNIT
RO
FRAME
GLASS

2'-9 7/16"
2'-10 3/16"
2'-9 7/16"
22 9/16"

5'-0"
5'-0 3/4"
5'-0"
22 9/16"

7'-9 7/16"
7'-10 3/16"
7'-9 7/16"
22 9/16"

6'-7 1/2"
6'-8"
6'-7 1/2"
68"

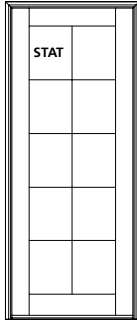

SCS4 2668

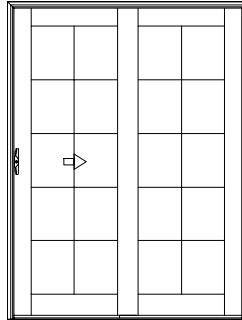

SCS4 5068

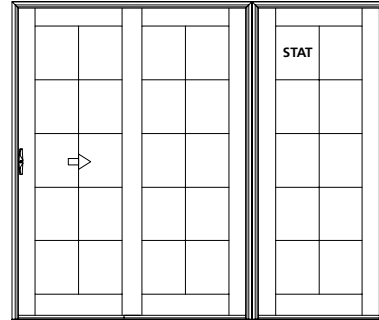

SCS4 7668

6'-10 1/2"
6'-11"
6'-10 1/2"
68"

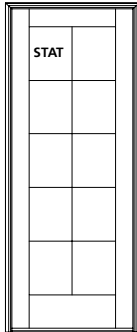

SCS4 26611

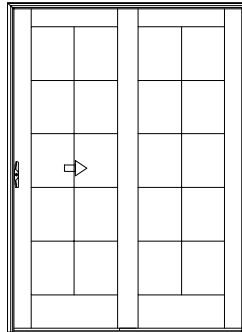

SCS4 50611

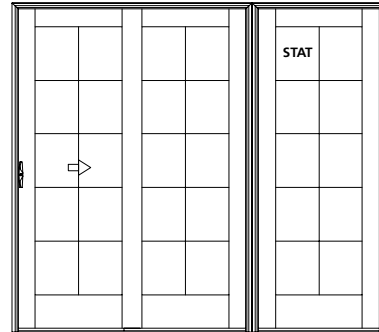

SCS4 76611

7'-11 1/2"
8'-0"
7'-11 1/2"
81"

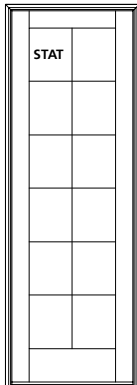

SCS4 2680

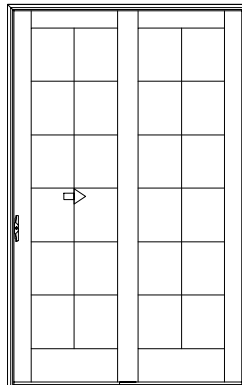

SCS4 5080

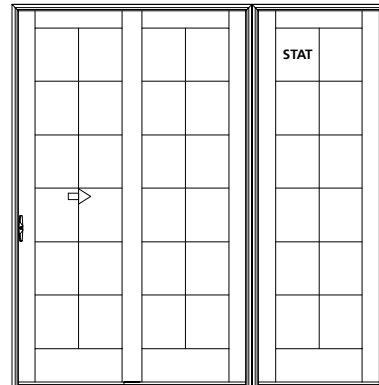

SCS4 7680

***Note:** See page 15-10 to specify handing.
400 series doors are not field reversible.

SCALE 1/4" = 1'

400 SERIES SLIDING PATIO DOOR

UNIT
RO
FRAME
GLASS

3'-3 7/16"
3'-4 3/16"
3'-3 7/16"
28 9/16"

6'-0"
6'-0 3/4"
6'-0"
28 9/16"

9'-3 7/16"
9'-4 3/16"
9'-3 7/16"
28 9/16"

6'-7 1/2"
6'-8"
6'-7 1/2"
68"

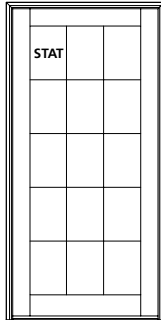

SCS4 3068

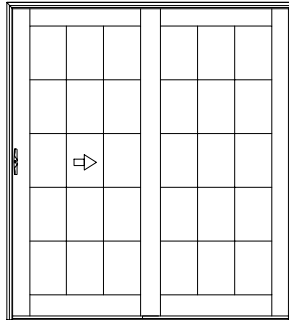

SCS4 6068

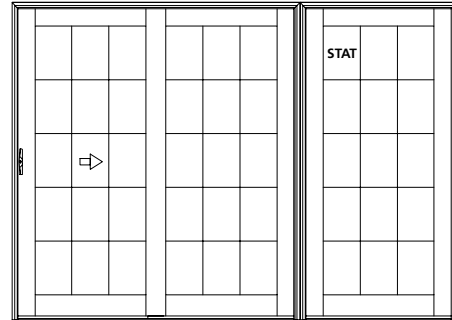

SCS4 9068

6'-10 1/2"
6'-11"
6'-10 1/2"
68"

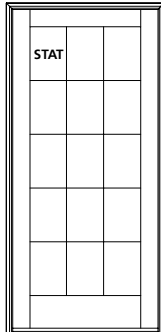

SCS4 30611

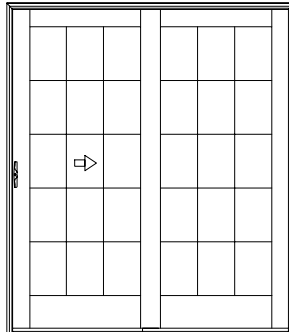

SCS4 60611

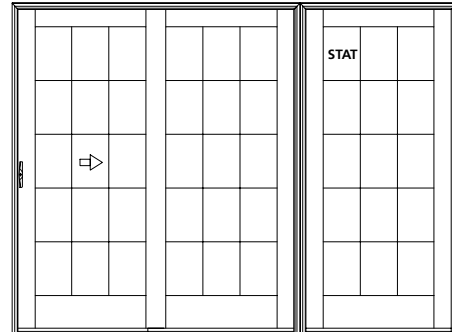

SCS4 90611

7'-11 1/2"
8'-0"
7'-11 1/2"
81"

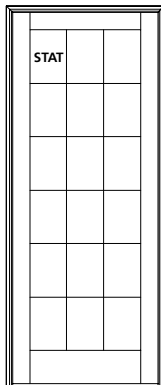

SCS4 3080

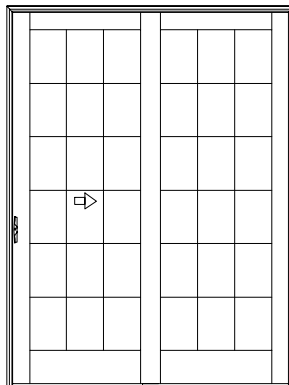

SCS4 6080

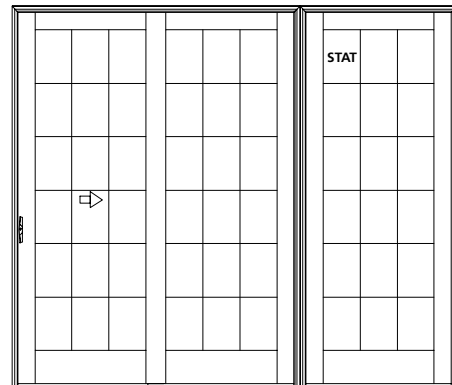

SCS4 9080

***Note:** See page 15-10 to specify handing.
400 series doors are not field reversible.

SCALE 1/4" = 1'

400 SERIES SLIDING PATIO DOOR

UNIT
RO
FRAME
GLASS

4'-3 7/16"
4'-4 3/16"
4'-3 7/16"
40 9/16"

8'-0"
8'-0 3/4"
8'-0"
40 9/16"

12'-3 7/16"
12'-4 3/16"
12'-3 7/16"
40 9/16"

6'-7 1/2"
6'-8"
6'-7 1/2"
68"

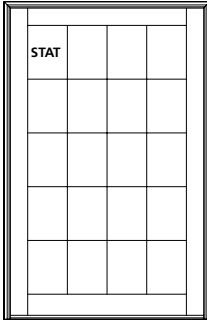

SCS4 4068

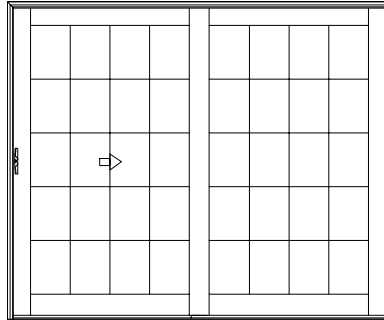

SCS4 8068

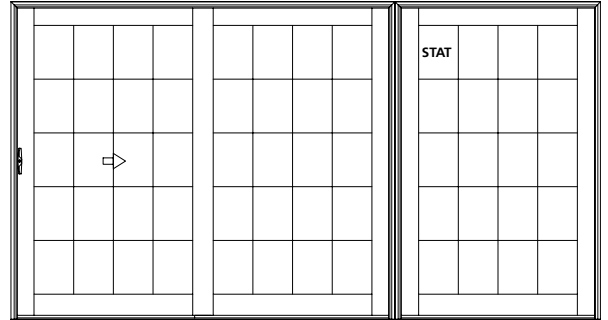

SCS4 12068

6'-10 1/2"
6'-11"
6'-10 1/2"
68"

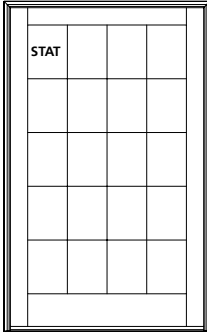

SCS4 40611

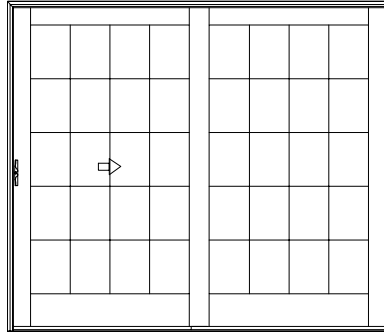

SCS4 80611

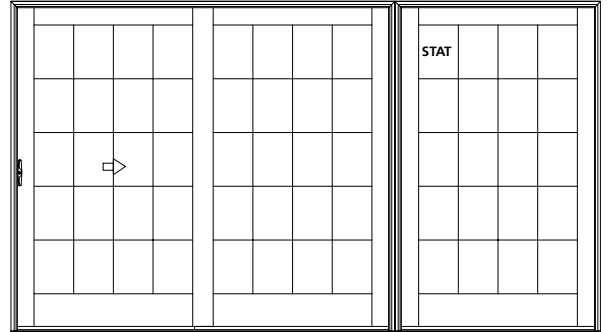

SCS4 120611

7'-11 1/2"
8'-0"
7'-11 1/2"
81"

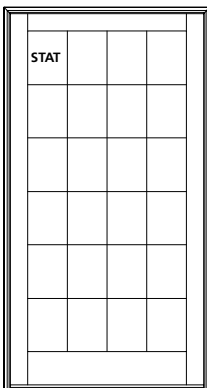

SCS4 4080

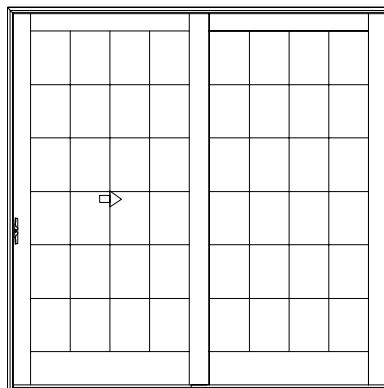

SCS4 8080

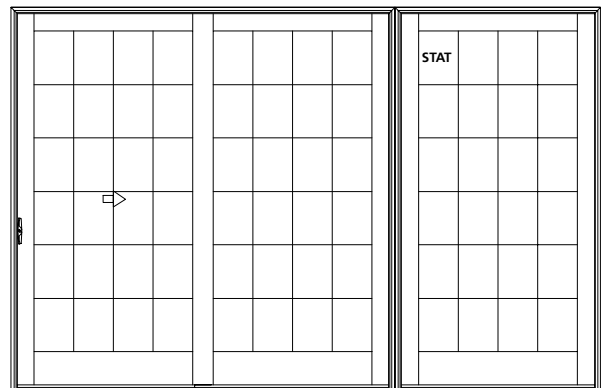

SCS4 12080

***Note:** See page 15-10 to specify handing.
400 series doors are not field reversible.

SCALE 1/4" = 1'

400 SERIES 4-PANEL SLIDING PATIO DOOR

UNIT
RO
FRAME
GLASS

9'-10"
9'-10 3/4"
9'-10"
22 9/16"

11'-10"
11'-10 3/4"
11'-10"
28 9/16"

6'-7 1/2"
6'-8"
6'-7 1/2"
68"

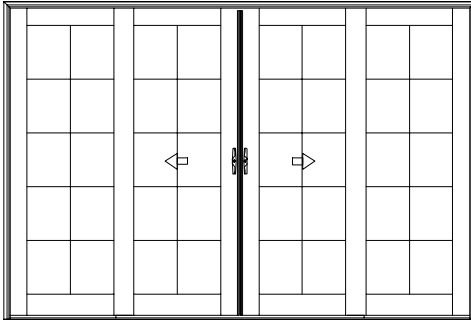

SCS4 100Q68

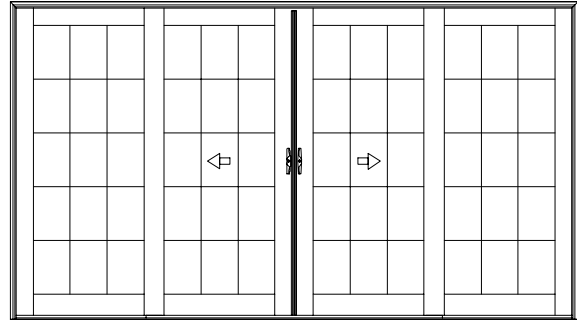

SCS4 120Q68

6'-10 1/2"
6'-11"
6'-10 1/2"
68"

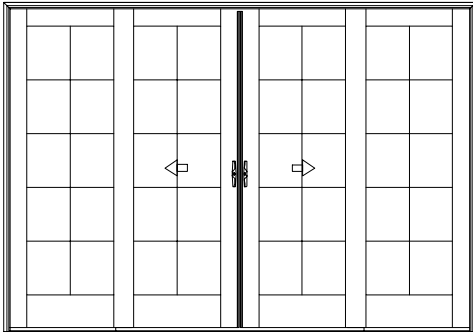

SCS4 100Q611

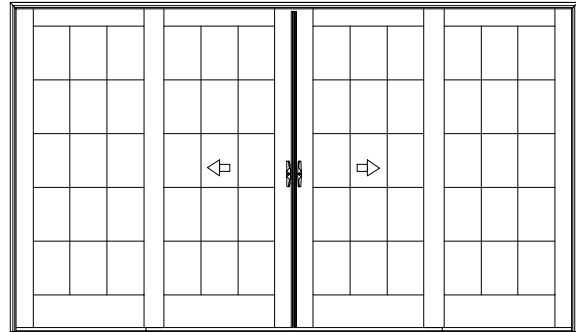

SCS4 120Q611

7'-11 1/2"
8'-0"
7'-11 1/2"
81"

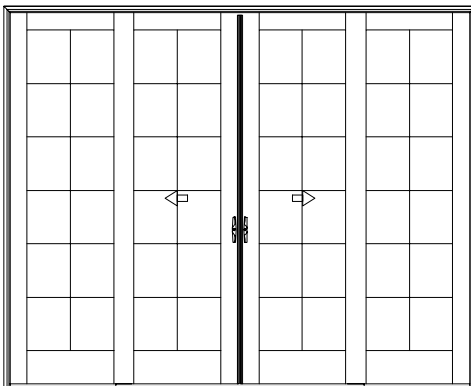

SCS4 100Q80

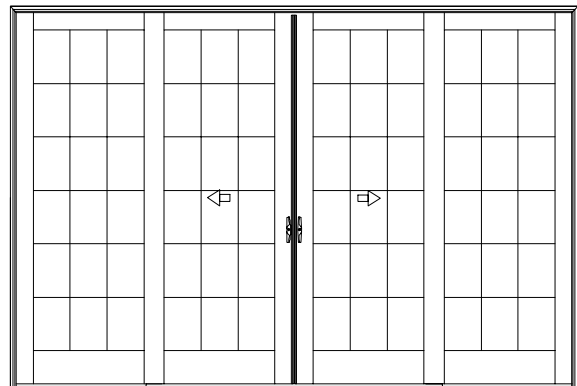

SCS4 120Q80

***Note:** See page 15-10 to specify handing.
4-Panel doors are not field reversible.

SCALE 1/4" = 1'

400 SERIES 4-PANEL SLIDING PATIO DOOR

UNIT	15'-10"
RO	15'-10 3/4"
FRAME	15'-10"
GLASS	40 9/16"

6'-7 1/2"
6'-8"
6'-7 1/2"
68"

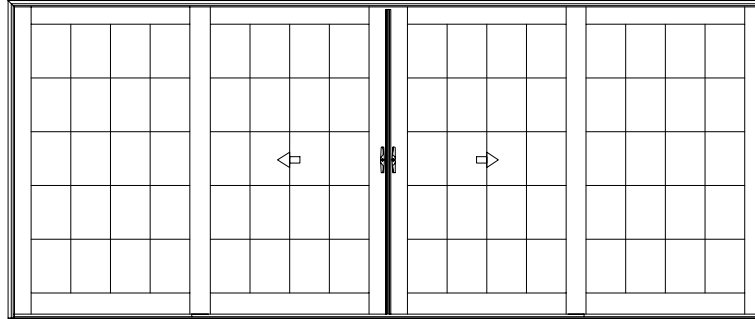

SCS4 160Q68

6'-10 1/2"
6'-11"
6'-10 1/2"
68"

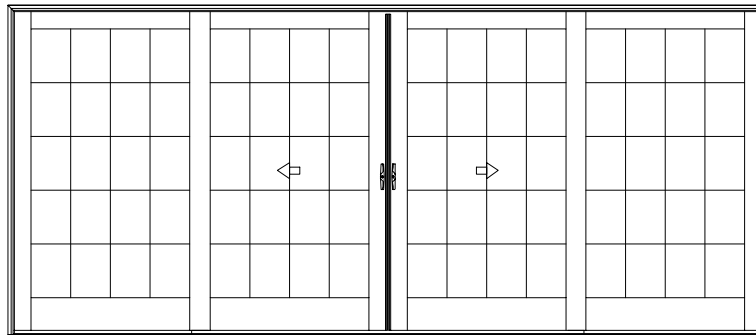

SCS4 160Q611

7'-11 1/2"
8'-0"
7'-11 1/2"
81"

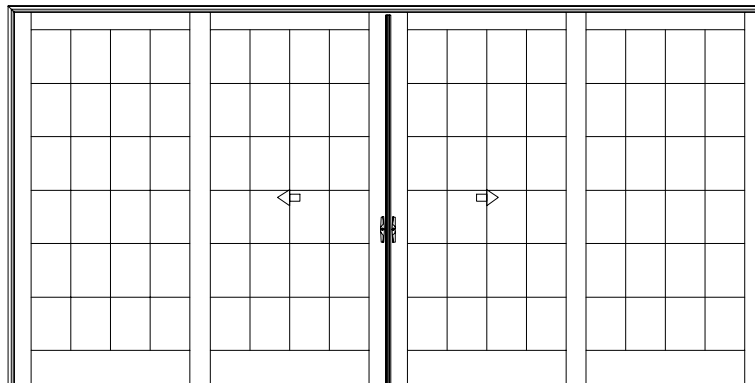

SCS4 160Q80

***Note:** See page 15-10 to specify handing.
4-Panel doors are not field reversible.

SCALE 1/4" = 1'

400 SERIES TRANSOM ALIGNMENT GUIDE

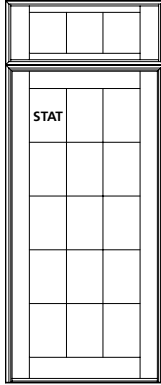

ONE PANEL TRANSOM

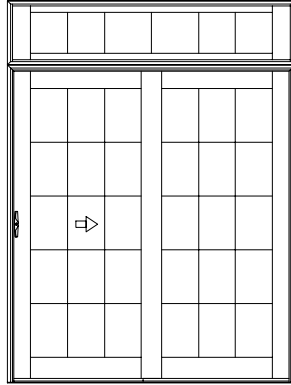

ONE PANEL TRANSOM

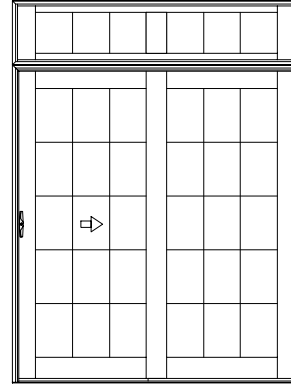

ONE PANEL (2-LITE) TRANSOM

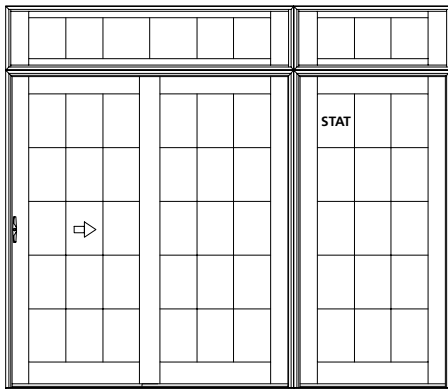

ONE PANEL TRANSOM

ONE PANEL TRANSOM

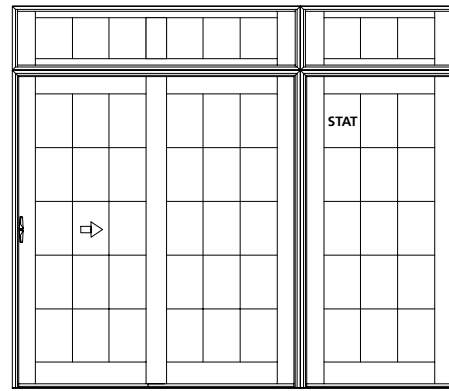

ONE PANEL (2-LITE) TRANSOM

ONE PANEL TRANSOM

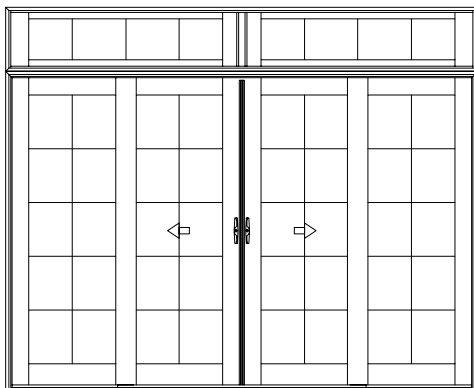



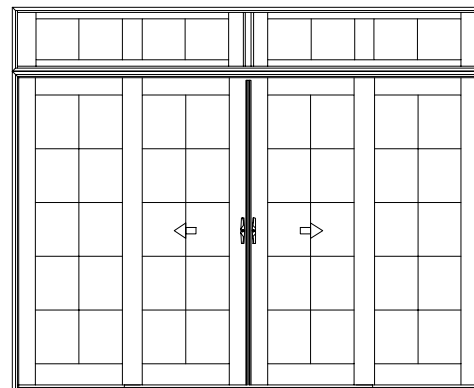







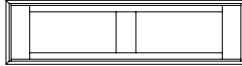



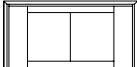
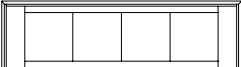
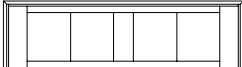

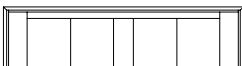
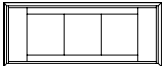
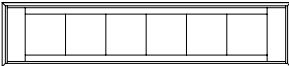
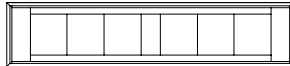

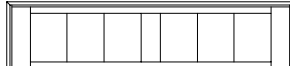



QUAD 2-PANEL TRANSOM
AVAILABLE ON 10-0 & 12-0 WIDTHS ONLY

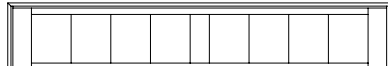

QUAD 2-PANEL (4-LITE) TRANSOM
(WILL ALIGN WITH INTERLOCKS ON QUAD DOOR)
AVAILABLE ON 10-0 & 12-0 WIDTHS ONLY

400 SERIES SLIDING DOOR TRANSOM

			
UNIT	2'-9 7/16"	5'-0"	5'-0"
RO	2'-10 3/16"	5'-0 3/4"	5'-0 3/4"
FRAME	2'-9 7/16"	5'-0"	5'-0"
GLASS	22 9/16"	49 5/16"	22 9/16"
1'-4" 1'-4 1/2" 1'-4"			
	SCS4 2614-1	SCS4 5014-1	SCS4 5014-2
1'-6" 1'-6 1/2" 1'-6"			
	SCS4 2616-1	SCS4 5016-1	SCS4 5016-2
2'-0" 2'-0 1/2" 2'-0"			
	SCS4 2620-1	SCS4 5020-1	SCS4 5020-2
UNIT	3'-3 7/16"	6'-0"	6'-0"
RO	3'-4 3/16"	6'-0 3/4"	6'-0 3/4"
FRAME	3'-3 7/16"	6'-0"	6'-0"
GLASS	28 9/16"	61 5/16"	28 9/16"
1'-4" 1'-4 1/2" 1'-4"			
	SCS4 3014-1	SCS4 6014-1	SCS4 6014-2
1'-6" 1'-6 1/2" 1'-6"			
	SCS4 3016-1	SCS4 6016-1	SCS4 6016-2
2'-0" 2'-0 1/2" 2'-0"			
	SCS4 3020-1	SCS4 6020-1	SCS4 6020-2
UNIT	4'-3 7/16"	8'-0"	8'-0"
RO	4'-4 3/16"	8'-0 3/4"	8'-0 3/4"
FRAME	4'-3 7/16"	8'-0"	8'-0"
GLASS	40 9/16"	85 5/16"	40 9/16"
1'-4" 1'-4 1/2" 1'-4"			
	SCS4 4014-1	SCS4 8014-1	SCS4 8014-2
1'-6" 1'-6 1/2" 1'-6"			
	SCS4 4016-1	SCS4 8016-1	SCS4 8016-2
2'-0" 2'-0 1/2" 2'-0"			
	SCS4 4020-1	SCS4 8020-1	SCS4 8020-2

*Note: See Horizontal Section on page 15-62 for post detail.

SCALE 1/4" = 1'

400 SERIES SLIDING PATIO DOOR TRANSOMS

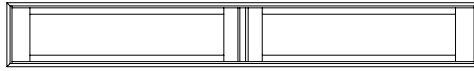

QUAD 2-PANEL TRANSOM

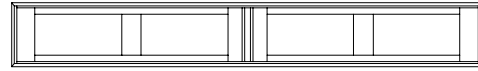

QUAD 2-PANEL (4-LITE) TRANSOM*
(WILL ALIGN WITH INTERLOCKS ON QUAD DOOR)

UNIT
RO
FRAME
GLASS

9'-10"
9'-10 3/4"
9'-10"
49 5/16"

9'-10"
9'-10 3/4"
9'-10"
22 9/16"

1'-4"
1'-4 1/2"
1'-4"
11 1/16"

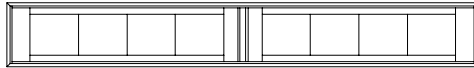

SCS4 10014-2

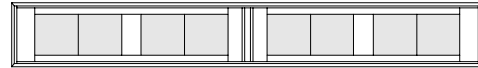

SCS4 10014-4

1'-6"
1'-6 1/2"
1'-6"
13 1/16"



SCS4 10016-2



SCS4 10016-4

2'-0"
2'-0 1/2"
2'-0"
19 1/16"

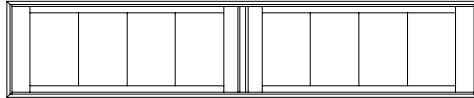

SCS4 10020-2

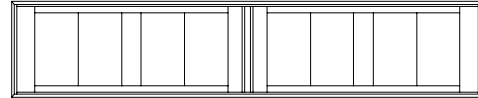

SCS4 10020-4

UNIT
RO
FRAME
GLASS

11'-10"
11'-10 3/4"
11'-10"
61 5/16"

11'-10"
11'-10 3/4"
11'-10"
28 9/16"

1'-4"
1'-4 1/2"
1'-4"
11 1/16"

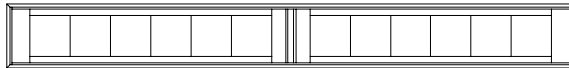

SCS4 12014-2

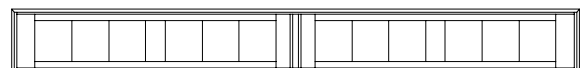

SCS4 12014-4

1'-6"
1'-6 1/2"
1'-6"
13 1/16"



SCS4 12016-2



SCS4 12016-4

2'-0"
2'-0 1/2"
2'-0"
19 1/16"

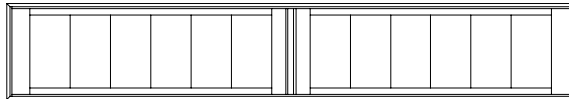

SCS4 12020-2

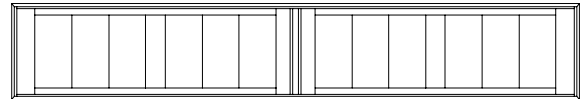

SCS4 12020-4

***Note:** See Horizontal Section on page 15-62 for post detail.

SCALE 1/4" = 1'

PANEL GLAZING OPTIONS

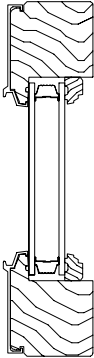

3/4" INSULATED

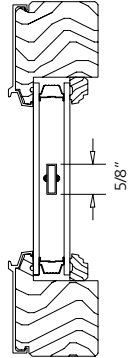

3/4" INSULATED WITH 5/8" GBG

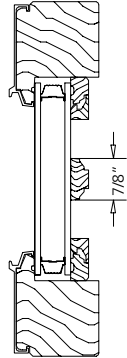

3/4" INSULATED WITH 7/8" FULL SURROUND WOOD GRILLE

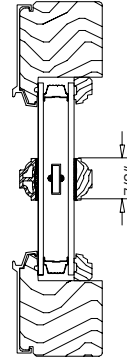

3/4" INSULATED WITH 7/8" BEAD SDL WITH LIGHT BRONZE SHADOW BAR

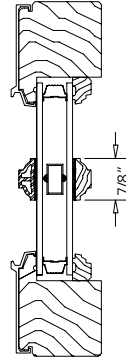

3/4" INSULATED WITH 7/8" BEAD SDL WITH SILVER SHADOW BAR

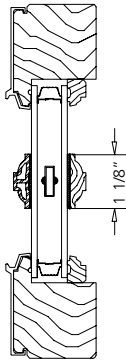

3/4" INSULATED WITH 1 1/8" BEAD SDL WITH LIGHT BRONZE SHADOW BAR

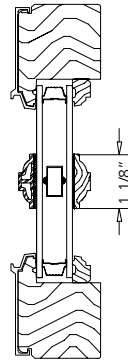

3/4" INSULATED WITH 1 1/8" BEAD SDL WITH SILVER SHADOW BAR

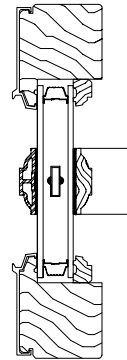

3/4" INSULATED WITH 1 3/8" BEAD SDL WITH LIGHT BRONZE SHADOW BAR

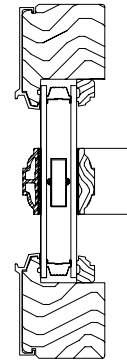

3/4" INSULATED WITH 1 3/8" BEAD SDL WITH SILVER SHADOW BAR

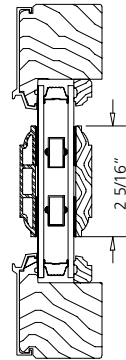

3/4" INSULATED WITH 2 5/16" BEAD SDL/ SIMULATED CHECK RAIL WITH SILVER SHADOW BAR

NOTE: KD Wood Grilles are not available in sliding doors.

NOTE: SDL not available on textured glass.

SCALE: 3" = 1'

TRIM OPTIONS

EXTERIOR TRIM

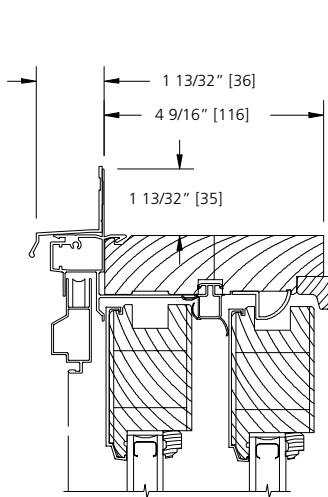

STANDARD

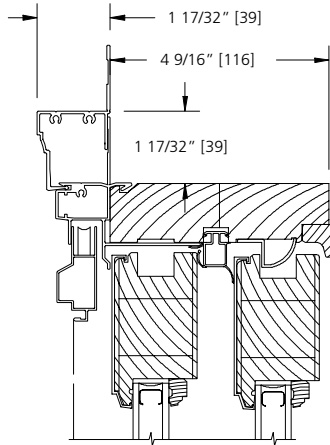

BRICKMOULD

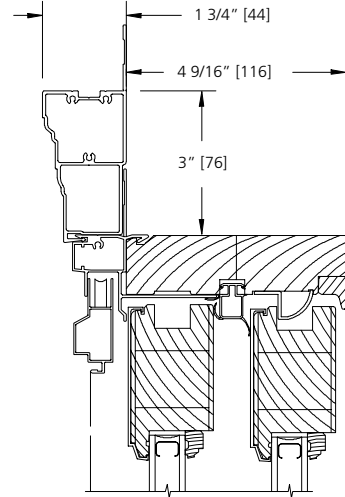

ADAMS CASING

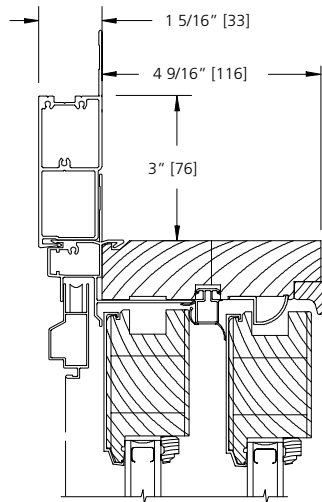

3 1/2\"/>

SCALE: 3" = 1'

LITE CUT INFORMATION

Clad Sliding patio doors are available in 7/8", 1-1/8" and 1-3/8" widths for SDL (Simulated Divided Lites), 5/8", 23/32" and 1" GBG (Grilles between the Glass) and 7/8" removable grilles. Standard lite cuts are rectangular.

LITE CUT OPTIONS

Special lite cut patterns can include a wide variety of straight line and radius patterns. The illustrations shown here represent just a few of the possibilities. Rectangular, horizontal, vertical and Prairie lite patterns are available in all standard size Clad Sliding patio doors. Uneven, diamond, radius and Gothic lite cuts are available, subject to approval. Approvals are based on the ability to fulfill the design requirement while maintaining the construction integrity of the finished product.

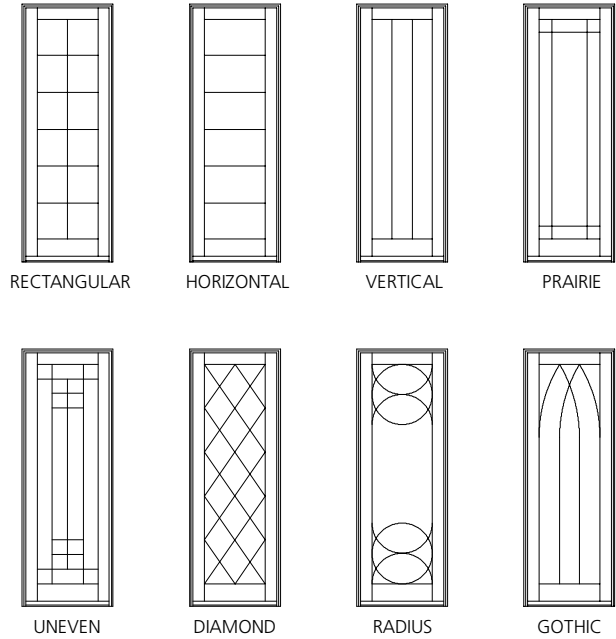

BAR ALIGNMENT

Alignment of divided lite muntin bars from one product to the next is often required by fine architectural design. Wood grilles, GBG's, and Simulated Divided Lites may be specified with muntin bars aligned.

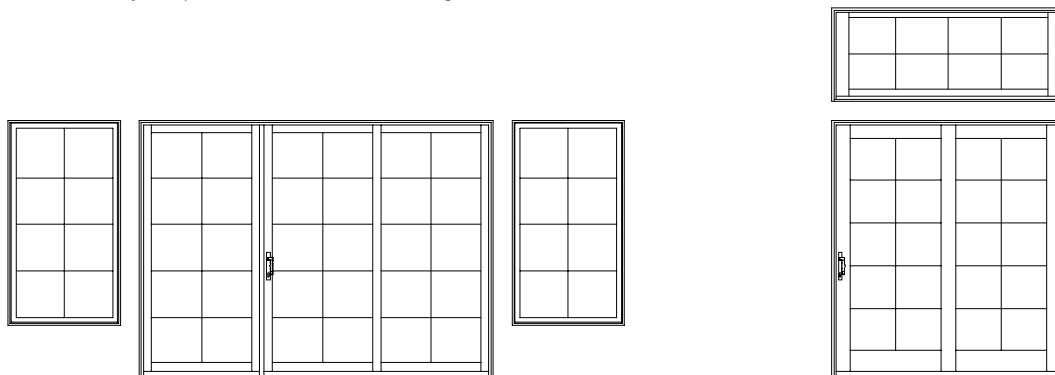

GRILLES & SDL LITE PATTERNS

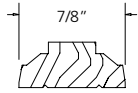

**7/8" WOOD GRILLE
FOR FULL SURROUND**

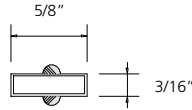

5/8" AIRSPACE GRILLE

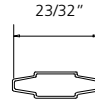

CONTOUR AIRSPACE GRILLE

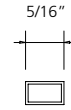

**5/16" AIRSPACE GRILLE ¹
(BRASS ONLY)**

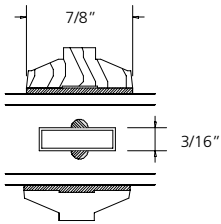

**7/8" SDL
WITH SHADOW BAR**

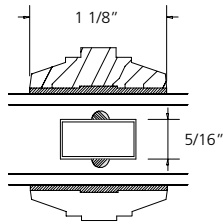

**1 1/8" SDL
WITH SILVER SPACER**

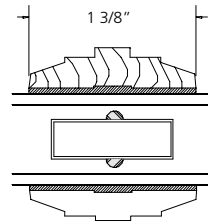

**1 3/8" SDL
WITH SILVER SPACER**

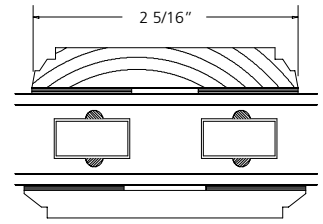

**2 5/16" SIMULATED CHECK RAIL ¹
WITH SILVER SPACER BARS**

EXAMPLES OF POSSIBLE LITE PATTERNS ²

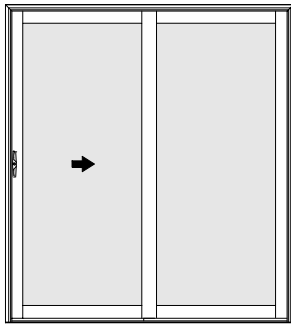

**ONE-LITE
(NO GRILLE OR SDL)**

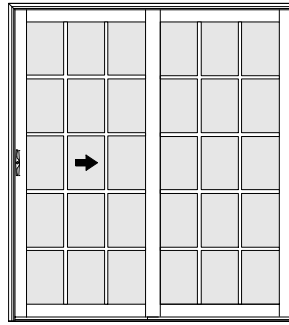

**15-LITE
3W5H STANDARD CUT ³**

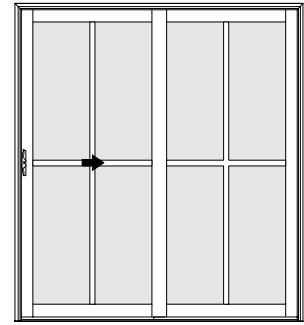

**4-LITE
2W2H CUSTOM CUT**

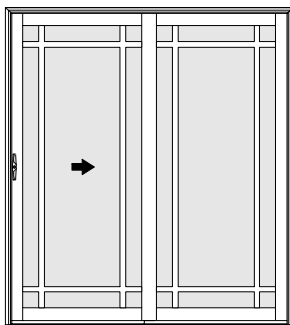

**9-LITE
3W3H MARGINAL (PRAIRIE)
LITE CUT
1 3/8" SDL W/4"
DAYLIGHT CORNERS**

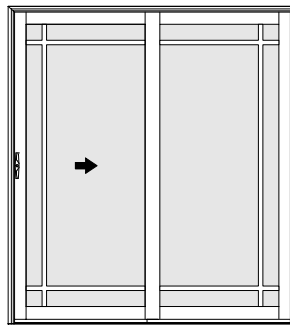

**6-LITE
2W3H CUSTOM CUT
LITE CUT
1 1/8" SDL W/4"
DAYLIGHT CORNERS**

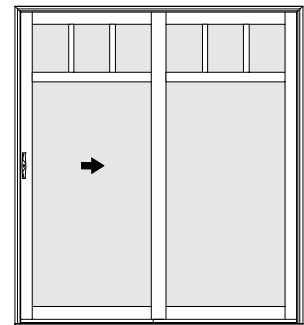

**4-LITE
2 5/16" HORIZONTAL SDL
WITH 3W1H
1 3/8" SDL
IN TOP OF PANEL**

¹ Not available in Radius Lite Patterns.

² Other Lite Patterns Available.

³ See Door Elevations for Standard Lite Patterns.

EXAMPLES NOT TO SCALE

GRILLES & SDL LITE PATTERNS

CLAD SLIDING PATIO DOORS - Standard Lite Patterns

Applies to all Wood Grilles, Airspace Grilles, and SDL (Simulated Divided Lite)

300 SERIES

6-8 HEIGHT		6-11 HEIGHT		8-0 HEIGHT	
UNIT SIZE	STANDARD LITE PATTERN	UNIT SIZE	STANDARD LITE PATTERN	UNIT SIZE	STANDARD LITE PATTERN
SCS3 2-6	2W x 5H	SCS3 2-6	2W x 5H	SCS3 2-6	2W x 6H
SCS3 5-0	2W x 5H	SCS3 5-0	2W x 5H	SCS3 5-0	2W x 6H
SCS3 7-6	2W x 5H	SCS3 7-6	2W x 5H	SCS3 7-6	2W x 6H
SCS3 3-0	3W x 5H	SCS3 3-0	3W x 5H	SCS3 3-0	3W x 6H
SCS3 6-0	3W x 5H	SCS3 6-0	3W x 5H	SCS3 6-0	3W x 6H
SCS3 9-0	3W x 5H	SCS3 9-0	3W x 5H	SCS3 9-0	3W x 6H
SCS3 4-0	4W x 5H	SCS3 4-0	4W x 5H	SCS3 4-0	4W x 6H
SCS3 8-0	4W x 5H	SCS3 8-0	4W x 5H	SCS3 8-0	4W x 6H
SCS3 12-0	4W x 5H	SCS3 12-0	4W x 5H	SCS3 12-0	4W x 6H
SCS3 10-0Q	2W x 5H	SCS3 10-0Q	2W x 5H	SCS3 10-0Q	2W x 6H
SCS3 12-0Q	3W x 5H	SCS3 12-0Q	3W x 5H	SCS3 12-0Q	3W x 6H
SCS3 16-0Q	4W x 5H	SCS3 16-0Q	4W x 5H	SCS3 16-0Q	4W x 6H

CUSTOM LITE PATTERNS ARE AVAILABLE

400 SERIES

6-8 HEIGHT		6-11 HEIGHT		8-0 HEIGHT	
UNIT SIZE	STANDARD LITE PATTERN	UNIT SIZE	STANDARD LITE PATTERN	UNIT SIZE	STANDARD LITE PATTERN
SCS4 2-6	2W x 5H	SCS4 2-6	2W x 5H	SCS4 2-6	2W x 6H
SCS4 5-0	2W x 5H	SCS4 5-0	2W x 5H	SCS4 5-0	2W x 6H
SCS4 7-6	2W x 5H	SCS4 7-6	2W x 5H	SCS4 7-6	2W x 6H
SCS4 3-0	3W x 5H	SCS4 3-0	3W x 5H	SCS4 3-0	3W x 6H
SCS4 6-0	3W x 5H	SCS4 6-0	3W x 5H	SCS4 6-0	3W x 6H
SCS4 9-0	3W x 5H	SCS4 9-0	3W x 5H	SCS4 9-0	3W x 6H
SCS4 4-0	4W x 5H	SCS4 4-0	4W x 5H	SCS4 4-0	4W x 6H
SCS4 8-0	4W x 5H	SCS4 8-0	4W x 5H	SCS4 8-0	4W x 6H
SCS4 12-0	4W x 5H	SCS4 12-0	4W x 5H	SCS4 12-0	4W x 6H
SCS4 10-0Q	2W x 5H	SCS4 10-0Q	2W x 5H	SCS4 10-0Q	2W x 6H
SCS4 12-0Q	3W x 5H	SCS4 12-0Q	3W x 5H	SCS4 12-0Q	3W x 6H
SCS4 16-0Q	4W x 5H	SCS4 16-0Q	4W x 5H	SCS4 16-0Q	4W x 6H

CUSTOM LITE PATTERNS ARE AVAILABLE

NOTE: LISTED LITE PATTERNS ARE PER DOOR PANEL

CLEAR OPENING LAYOUT
NARROW STYLE

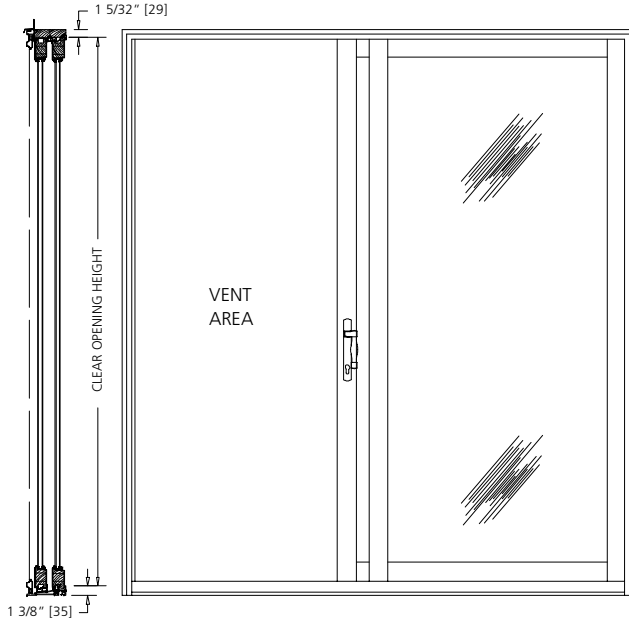

HORIZONTAL
Two Panel Assembly

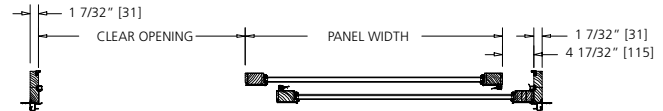

CLEAR OPENING FORMULA:

VERTICAL
Frame - 4 3/16" = Clear Opening

HORIZONTAL
Frame - (Panel Width + 7 5/8") = Clear Opening

HORIZONTAL
Three Panel End Operator

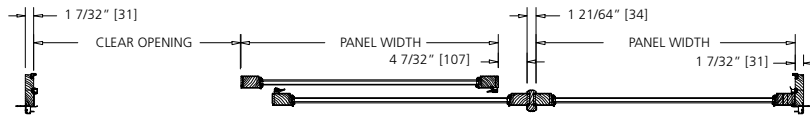

CLEAR OPENING FORMULA:

VERTICAL
Frame - 4 3/16" = Clear Opening

HORIZONTAL
Frame - ((2 x Panel Width) + 8 13/16") = Clear Opening

HORIZONTAL
Three Panel Center Operator

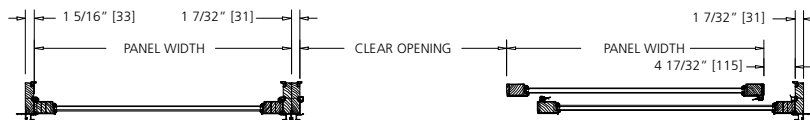

CLEAR OPENING FORMULA:

VERTICAL
Frame - 4 3/16" = Clear Opening

HORIZONTAL
Frame - ((2 x Panel Width) + 8 13/16") = Clear Opening



HORIZONTAL
Four Panel Assembly

CLEAR OPENING FORMULA:

VERTICAL
Frame - 4 3/16" = Clear Opening

HORIZONTAL
Frame - ((2 x (Panel Width + 5 3/4")) + 1 3/4") = Clear Opening

**CLEAR OPENING LAYOUT
WIDE STYLE**

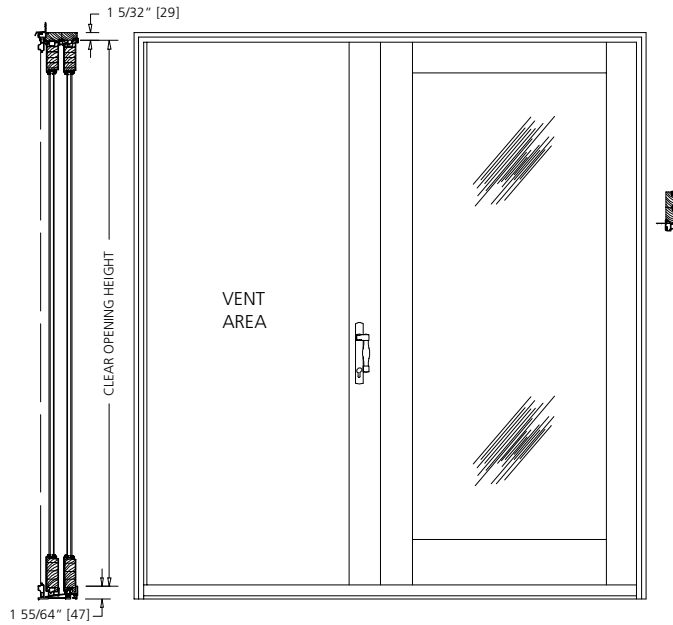

HORIZONTAL

Two Panel Assembly

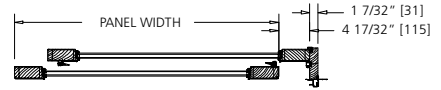

CLEAR OPENING FORMULA:

VERTICAL

Frame - 4 3/16" = Clear Opening

HORIZONTAL

Frame - (Panel Width + 7 5/8") = Clear Opening

HORIZONTAL

Three Panel End Operator

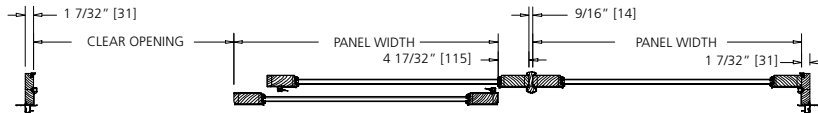

CLEAR OPENING FORMULA:

VERTICAL

Frame - 4 3/16" = Clear Opening

HORIZONTAL

Frame - ((2 x Panel Width) + 8 13/16") = Clear Opening

HORIZONTAL

Three Panel Center Operator

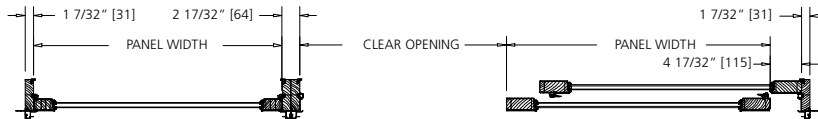

CLEAR OPENING FORMULA:

VERTICAL

Frame - 4 3/16" = Clear Opening

HORIZONTAL

Frame - ((2 x Panel Width) + 8 13/16") = Clear Opening



HORIZONTAL

Four Panel Assembly

CLEAR OPENING FORMULA:

VERTICAL

Frame - 4 3/16" = Clear Opening

HORIZONTAL

Frame - ((2 x (Panel Width + 5 3/4")) + 1 3/4") = Clear Opening

CLEAR OPENING AND DAYLIGHT SPECIFICATIONS

300 SERIES

Unit No.	Sq. Ft. Vent & Clear Opening	Clear Opening		Sq. Ft. Daylight Opening	Sq. Ft. Unit
		Width (in.)	Height (in.)		
SCS3 2-6x6-8	S.S.	S.S.	S.S.	11.65	18.08
SCS3 3-0x6-8	S.S.	S.S.	S.S.	14.59	21.39
SCS3 4-0x6-8	S.S.	S.S.	S.S.	20.47	28.02
SCS3 5-0x6-8	12.52	23 9/16	76 1/2	23.30	33.03
SCS3 6-0x6-8	15.70	29 9/16	76 1/2	29.18	39.75
SCS3 8-0x6-8	22.08	41 9/16	76 1/2	40.94	53.00
SCS3 10-0Qx6-8	25.04	47 1/8	76 1/2	46.60	66.06
SCS3 12-0Qx6-8	31.40	59 1/8	76 1/2	58.36	79.50
SCS3 16-0Qx6-8	44.16	83 1/8	76 1/2	81.88	106.00
SCS3 2-6x6-11	S.S.	S.S.	S.S.	12.14	18.76
SCS3 3-0x6-11	S.S.	S.S.	S.S.	15.21	22.20
SCS3 4-0x6-11	S.S.	S.S.	S.S.	21.34	29.08
SCS3 5-0x6-11	13.01	23 9/16	79 1/2	24.28	34.38
SCS3 6-0x6-11	16.32	29 9/16	79 1/2	30.42	41.25
SCS3 8-0x6-11	22.95	41 9/16	79 1/2	42.68	55.00
SCS3 10-0Qx6-11	26.02	47 1/8	79 1/2	48.56	68.76
SCS3 12-0Qx6-11	32.64	59 1/8	79 1/2	60.84	82.50
SCS3 16-0Qx6-11	45.90	83 1/8	79 1/2	85.36	110.00
SCS3 2-6x8-0	S.S.	S.S.	S.S.	14.28	21.72
SCS3 3-0x8-0	S.S.	S.S.	S.S.	17.90	25.70
SCS3 4-0x8-0	S.S.	S.S.	S.S.	25.11	33.66
SCS3 5-0x8-0	15.13	23 9/16	92 1/2	28.56	39.79
SCS3 6-0x8-0	18.99	29 9/16	92 1/2	35.80	47.75
SCS3 8-0x8-0	26.70	41 9/16	92 1/2	50.22	63.67
SCS3 10-0Qx8-0	30.26	47 1/8	92 1/2	57.12	79.58
SCS3 12-0Qx8-0	37.98	59 1/8	92 1/2	71.60	95.50
SCS3 16-0Qx8-0	53.40	83 1/8	92 1/2	100.44	127.34

400 SERIES

Unit No.	Sq. Ft. Vent & Clear Opening	Clear Opening		Sq. Ft. Daylight Opening	Sq. Ft. Unit
		Width (in.)	Height (in.)		
SCS4 2-6x6-8	S.S.	S.S.	S.S.	10.11	18.46
SCS4 3-0x6-8	S.S.	S.S.	S.S.	12.90	21.77
SCS4 4-0x6-8	S.S.	S.S.	S.S.	18.50	28.40
SCS4 5-0x6-8	12.15	22 7/8	76 1/2	20.22	33.03
SCS4 6-0x6-8	15.34	28 7/8	76 1/2	25.80	39.75
SCS4 8-0x6-8	21.71	40 7/8	76 1/2	37.00	53.00
SCS4 10-0Qx6-8	24.30	45 3/4	76 1/2	40.44	66.06
SCS4 12-0Qx6-8	30.68	57 3/4	76 1/2	51.60	79.50
SCS4 16-0Qx6-8	43.42	81 3/4	76 1/2	74.00	106.00
SCS4 2-6x6-11	S.S.	S.S.	S.S.	10.11	19.16
SCS4 3-0x6-11	S.S.	S.S.	S.S.	12.90	22.60
SCS4 4-0x6-11	S.S.	S.S.	S.S.	18.50	29.47
SCS4 5-0x6-11	12.63	22 7/8	79 1/2	20.22	34.38
SCS4 6-0x6-11	15.94	28 7/8	79 1/2	25.80	41.25
SCS4 8-0x6-11	22.57	40 7/8	79 1/2	37.00	55.00
SCS4 10-0Qx6-11	25.26	45 3/4	79 1/2	40.44	68.76
SCS4 12-0Qx6-11	31.88	57 3/4	79 1/2	51.60	82.50
SCS4 16-0Qx6-11	45.14	81 3/4	79 1/2	74.00	110.00
SCS4 2-6x8-0	S.S.	S.S.	S.S.	12.06	22.18
SCS4 3-0x8-0	S.S.	S.S.	S.S.	15.40	26.16
SCS4 4-0x8-0	S.S.	S.S.	S.S.	22.08	34.09
SCS4 5-0x8-0	15.69	22 7/8	92 1/2	24.12	39.79
SCS4 6-0x8-0	18.55	28 7/8	92 1/2	30.80	47.75
SCS4 8-0x8-0	26.26	40 7/8	92 1/2	44.16	63.67
SCS4 10-0Qx8-0	31.38	45 3/4	92 1/2	48.24	79.58
SCS4 12-0Qx8-0	37.10	57 3/4	92 1/2	61.60	95.50
SCS4 16-0Qx8-0	52.52	81 3/4	92 1/2	88.32	127.34

Note: S.S. denotes Stationary Sidelite.

**UNIT SIZING, ROUGH OPENINGS,
& MASONRY OPENINGS**

STANDARD OFFERING

DRIP CAP & NAILING FLANGE

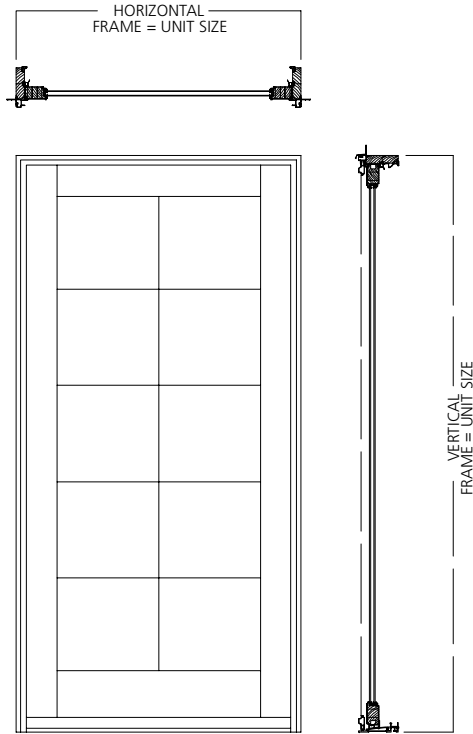

GENERAL NOTES:

UNITS WITH NO EXTERIOR TRIM OR DRIP CAP & NAILING FLANGE:
FRAME SIZE = UNIT SIZE

UNIT SIZE IS ALWAYS THE EXTREME SIZE OF THE DOOR WITH OR WITHOUT TRIM (DRIP CAP & NAILING FLANGE ARE NOT ADDED TO ANY UNIT SIZING)

ROUGH OPENING IS ALWAYS 3/4" OVER FRAME SIZE OF THE DOOR

MASONRY OPENING IS ALWAYS 1/2" OVER THE UNIT SIZE OF THE DOOR

ROUGH OPENING:

DRIP CAP & NAILING FLANGE

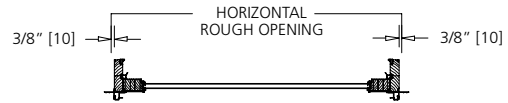

UNIT SIZE

FRAME TO EXTERIOR TRIM (UNIT) SIZE

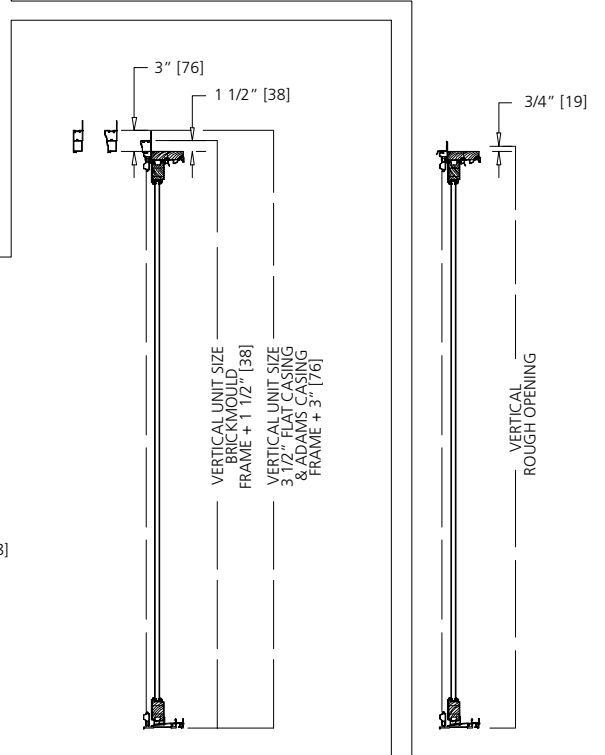
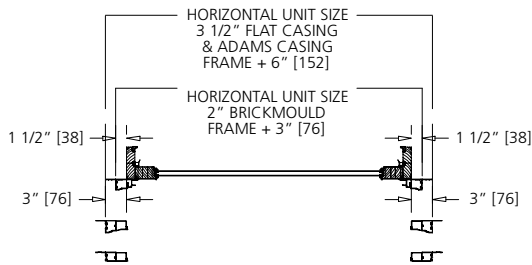

300 SERIES SLIDING PATIO DOOR

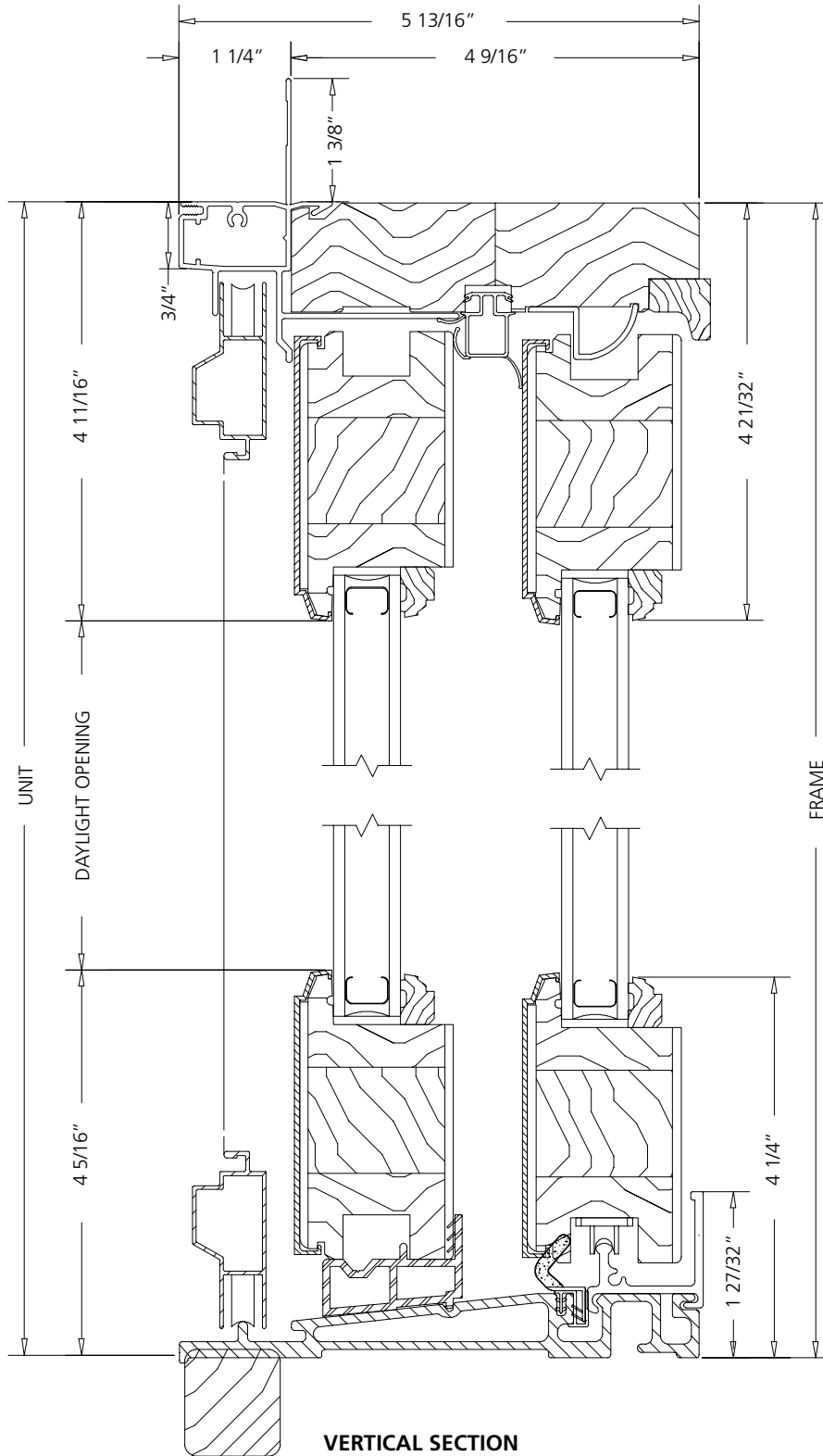

SCALE: 6" = 1'

300 SERIES SLIDING PATIO DOOR

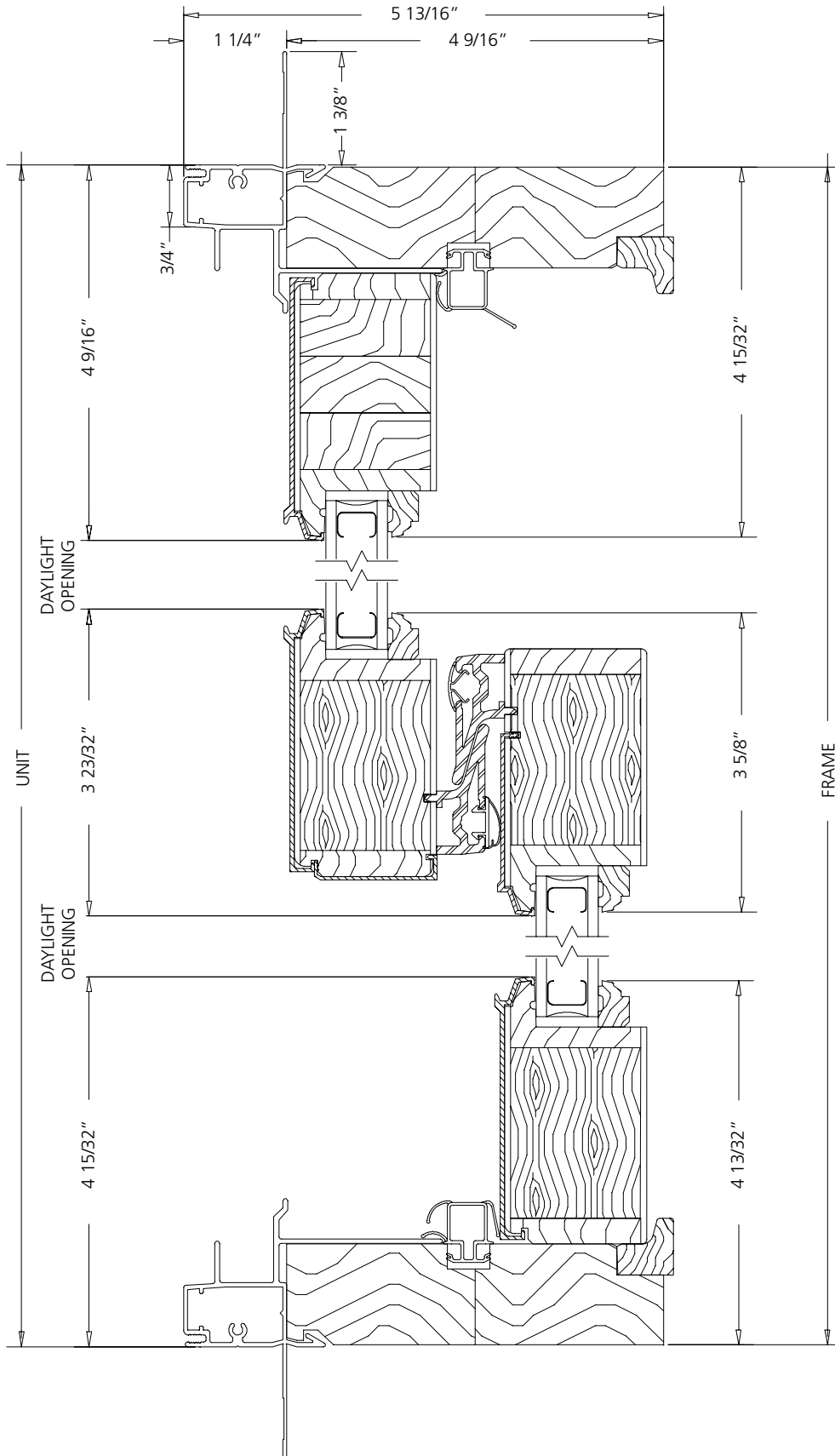

HORIZONTAL SECTION

SCALE: 6" = 1'

300 SERIES SIDELIGHT

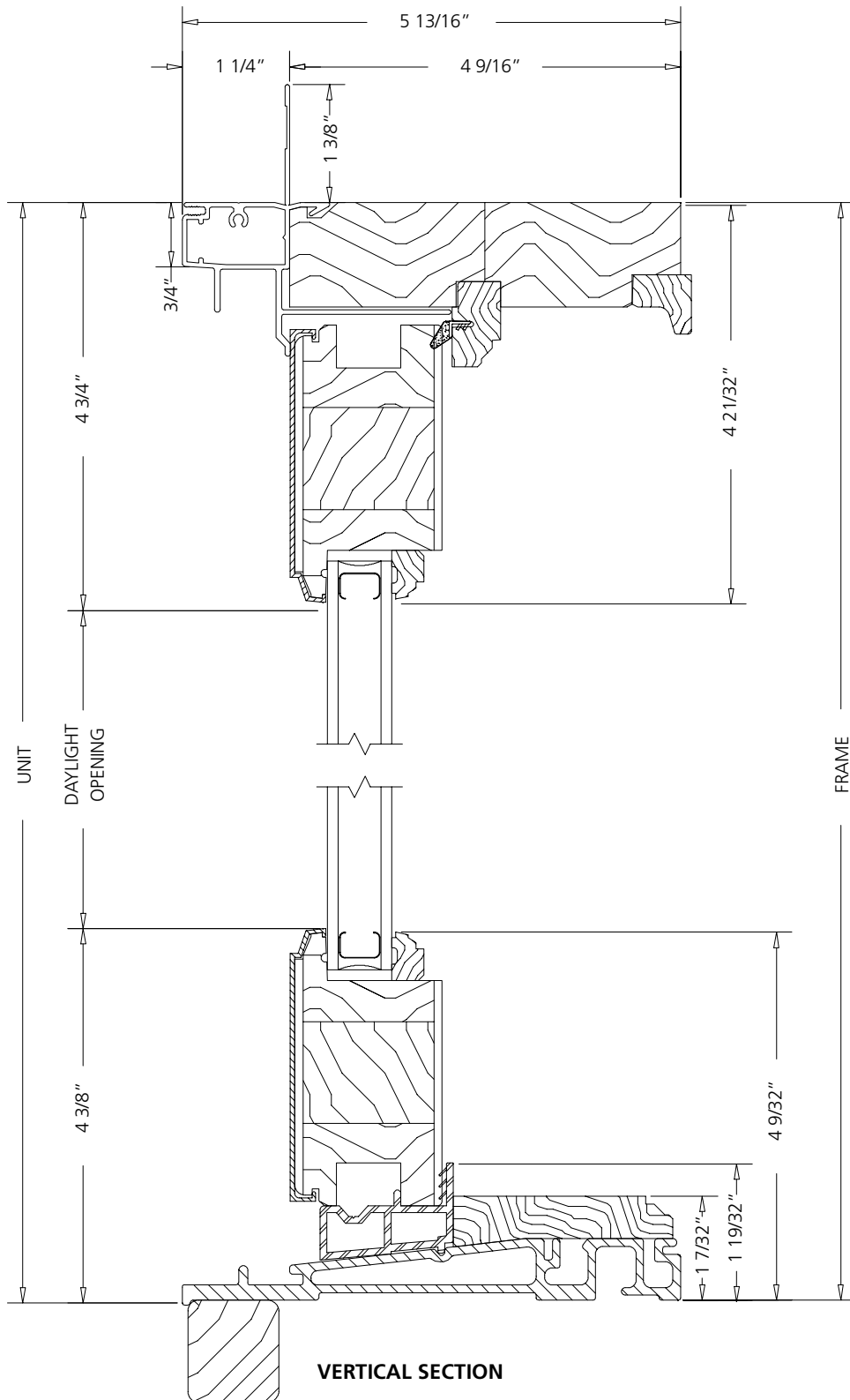

SCALE: 6" = 1'

300 SERIES SIDELIGHT

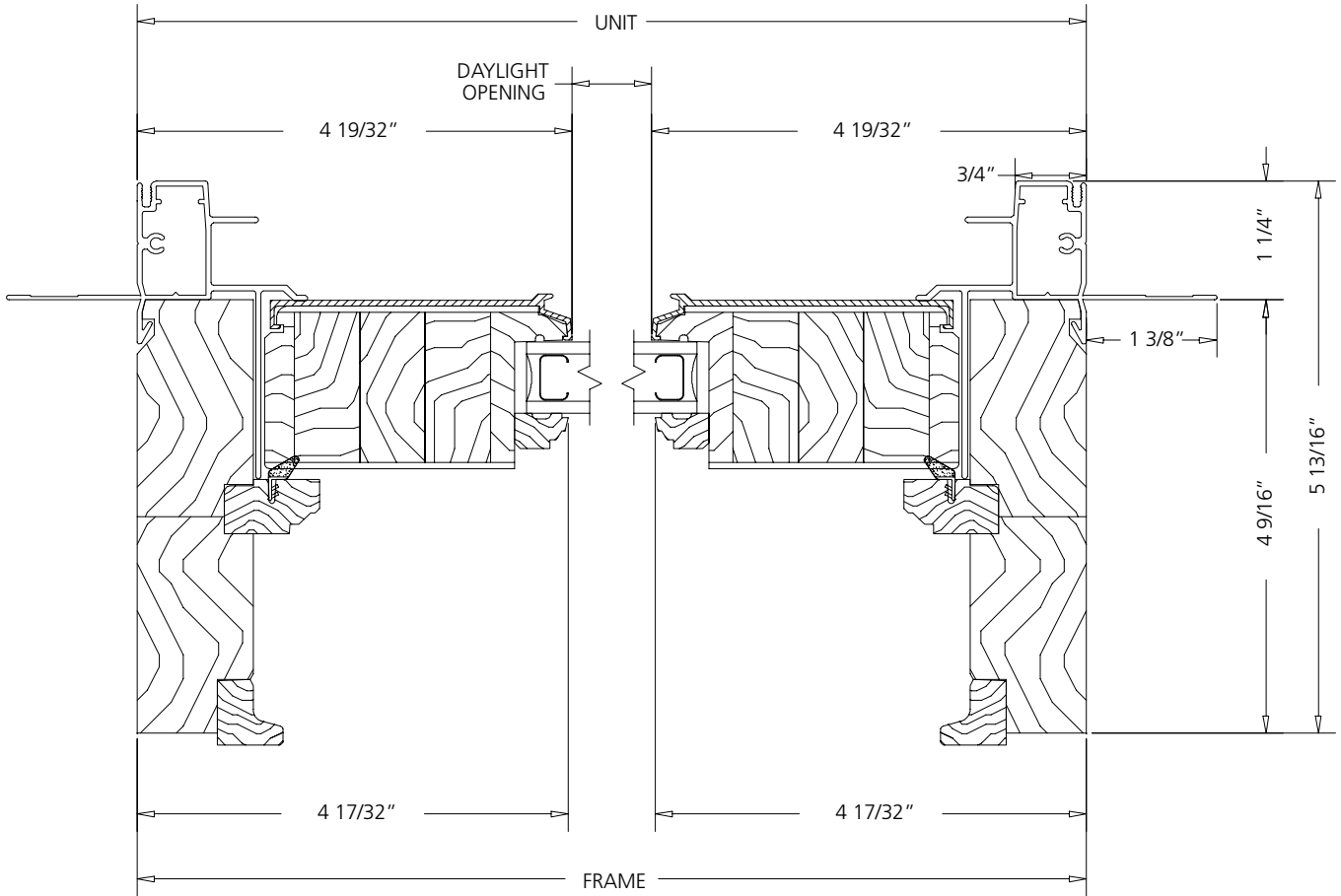

HORIZONTAL SECTION

SCALE: 6" = 1'

300 SERIES SIDELIGHT MULLION

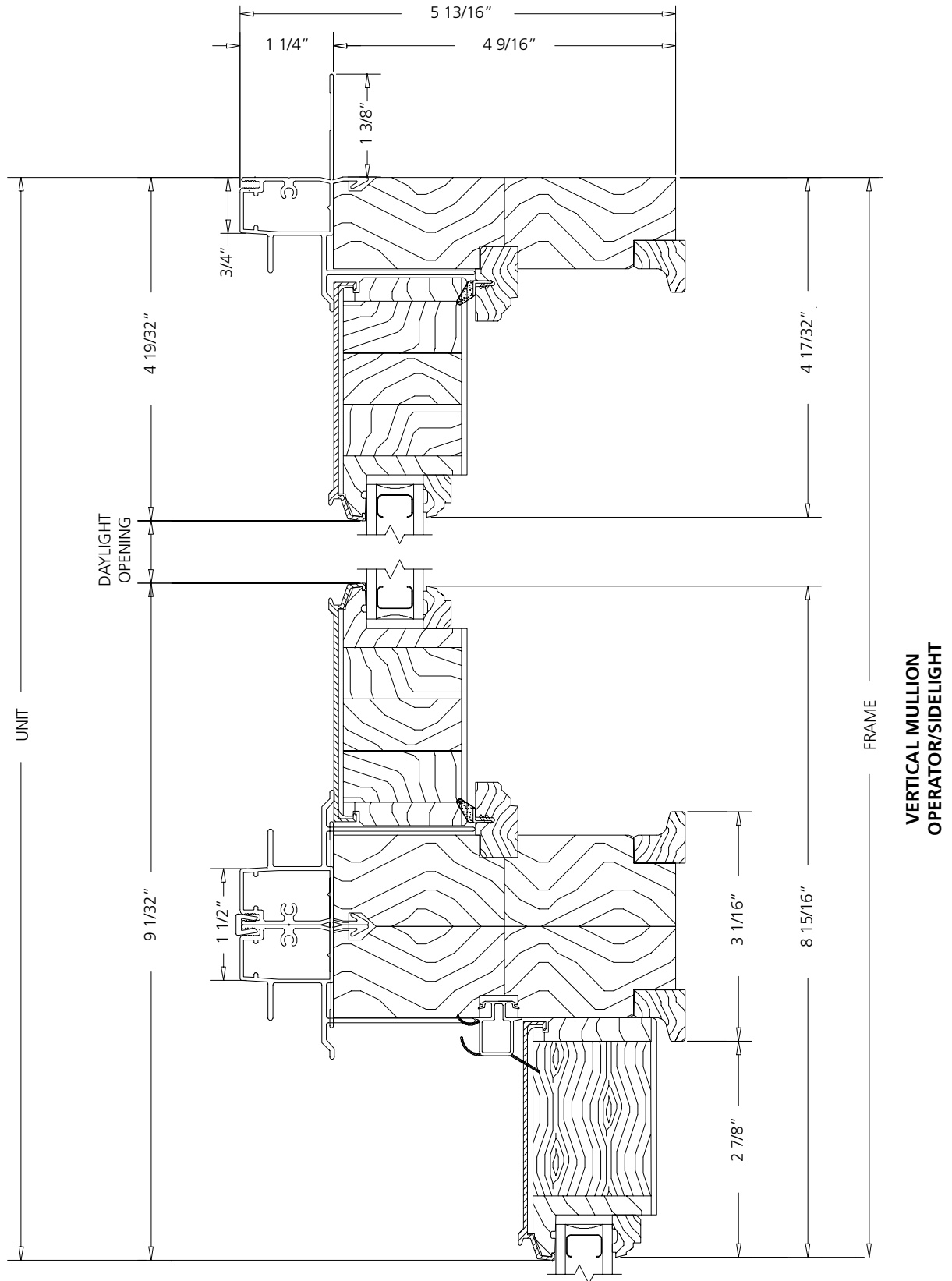

SCALE: 6" = 1'

300 SERIES 4-PANEL SLIDING PATIO DOORS

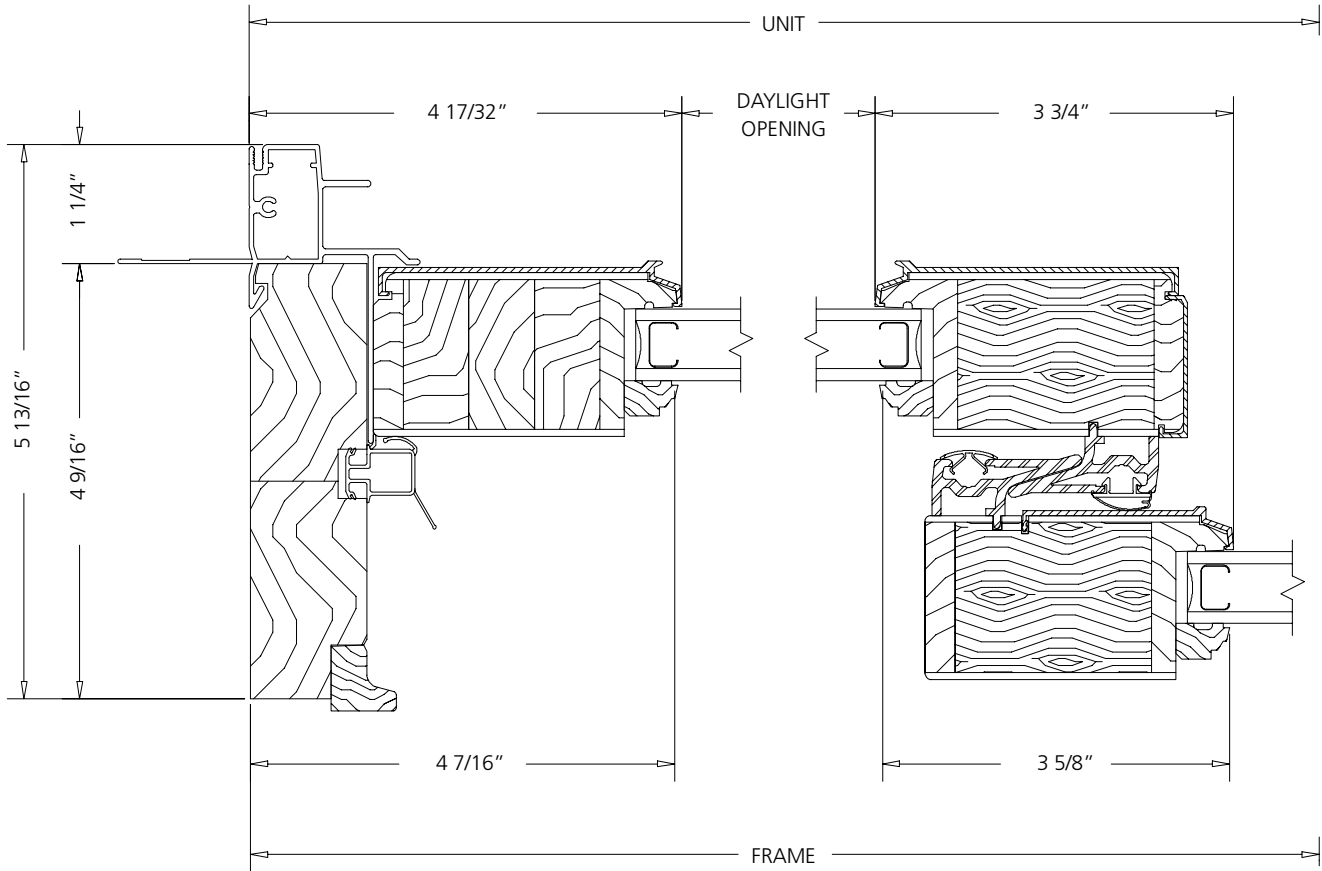

HORIZONTAL SECTION

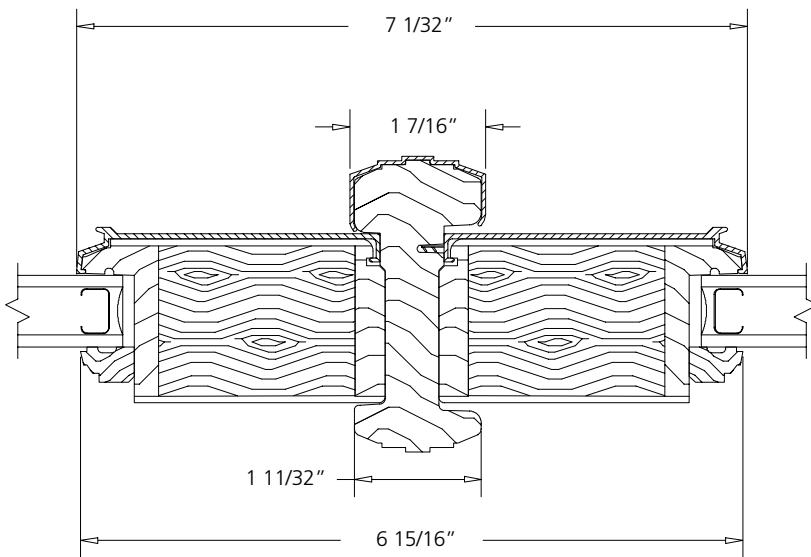

**ASTRAGAL DETAIL
VIEW A-A**

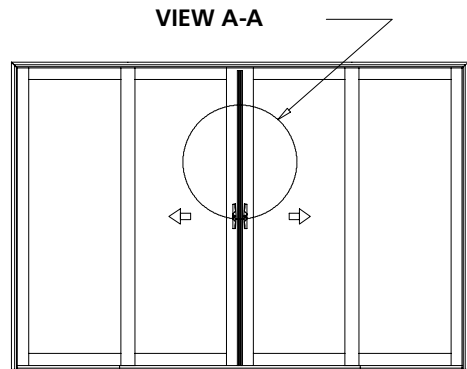

SCALE: 6" = 1'

300 SERIES SLIDING DOOR TRANSOMS

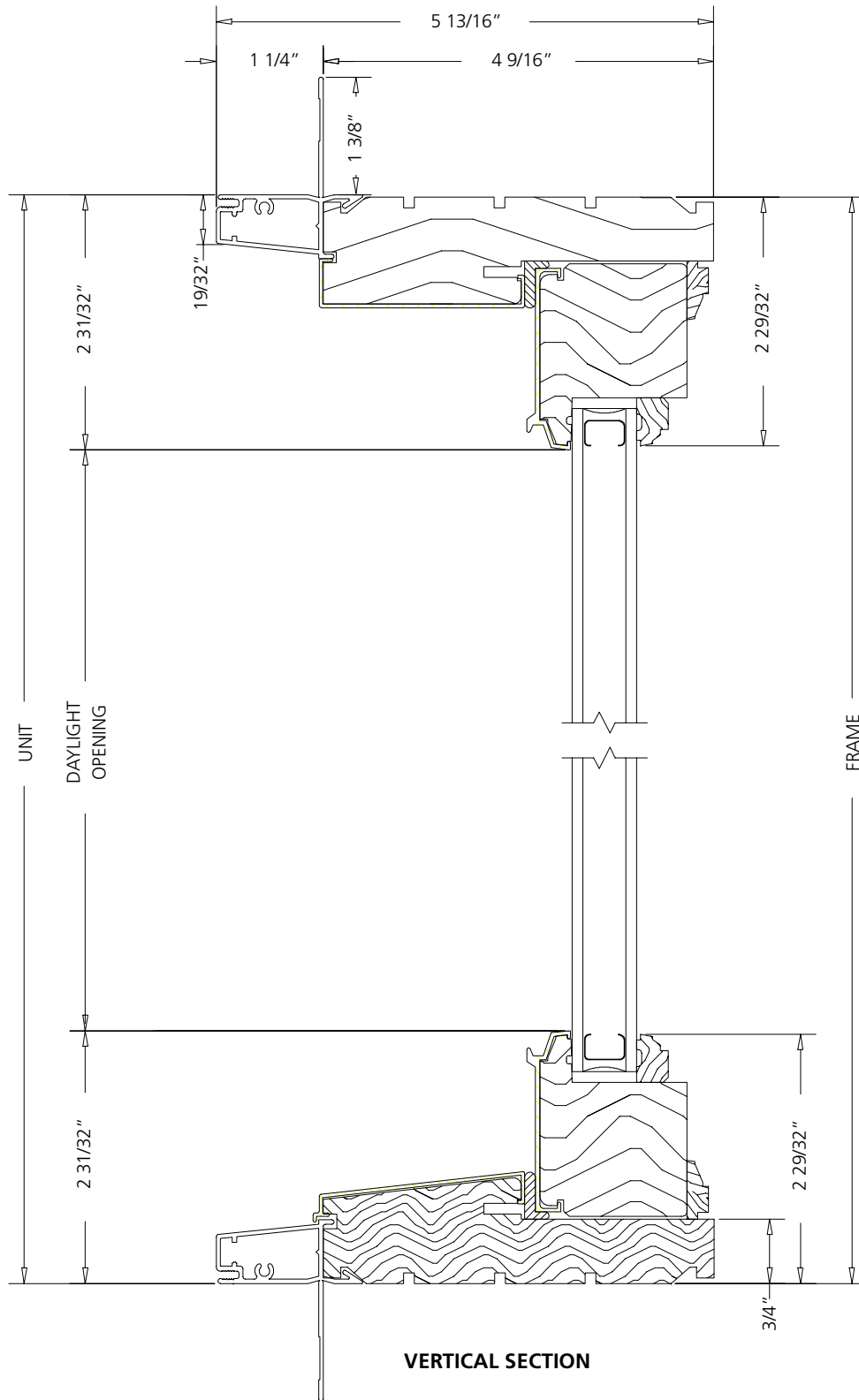

VERTICAL SECTION

SCALE: 6" = 1'

300 SERIES SLIDING DOOR TRANSOMS

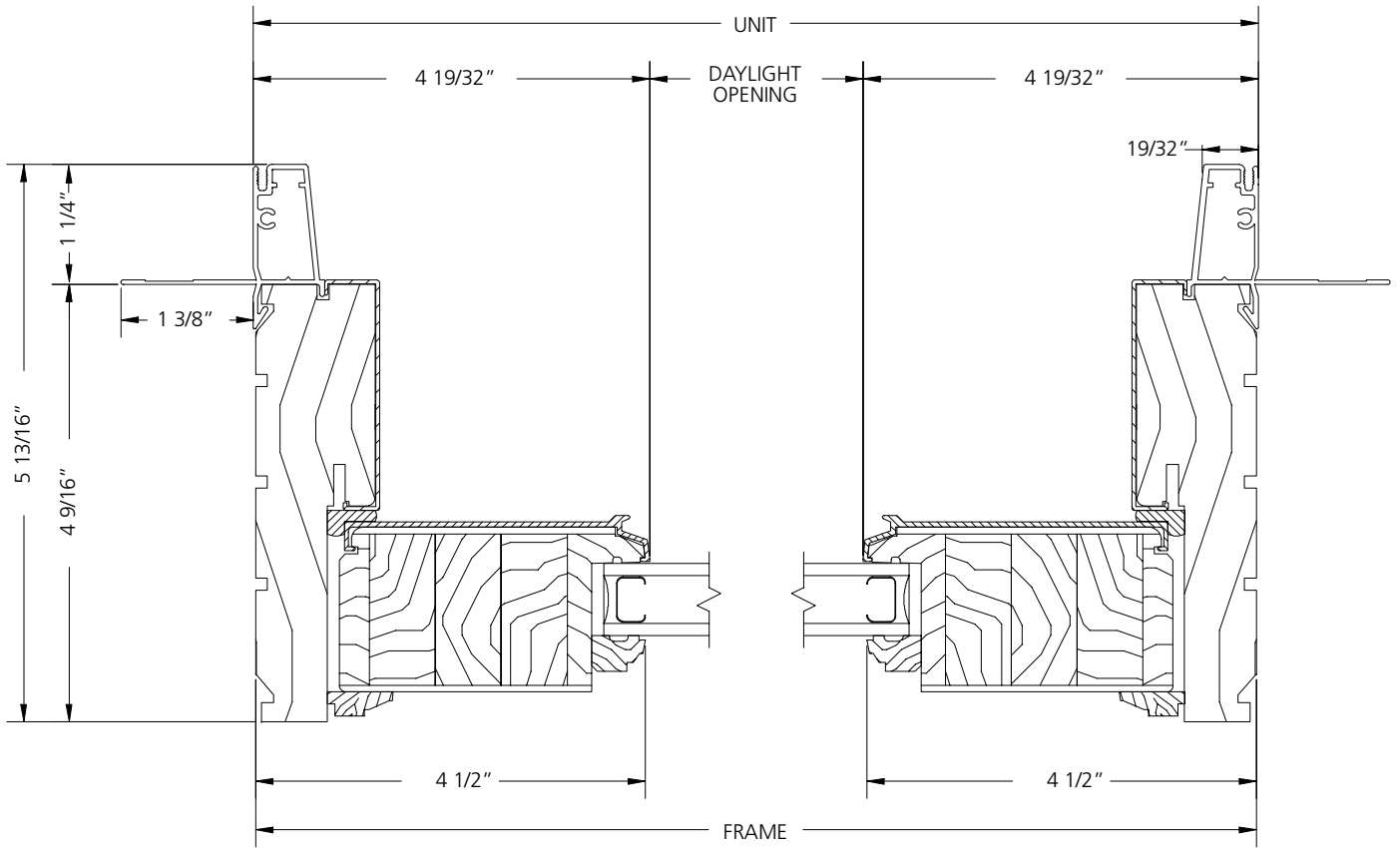

HORIZONTAL SECTION

SCALE: 6" = 1'

300 SERIES SLIDING DOOR JAMB DETAILS

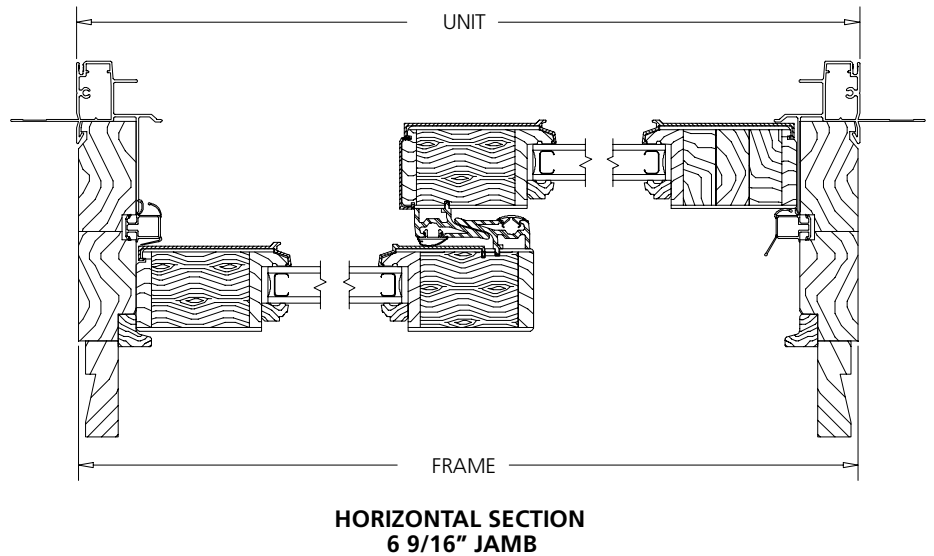
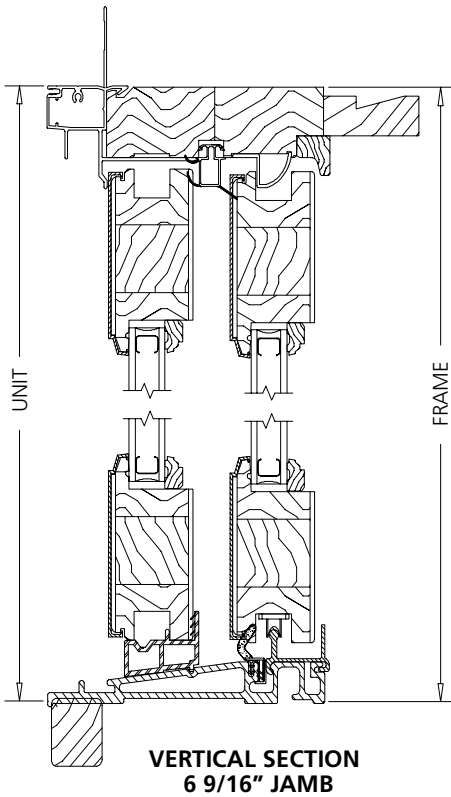
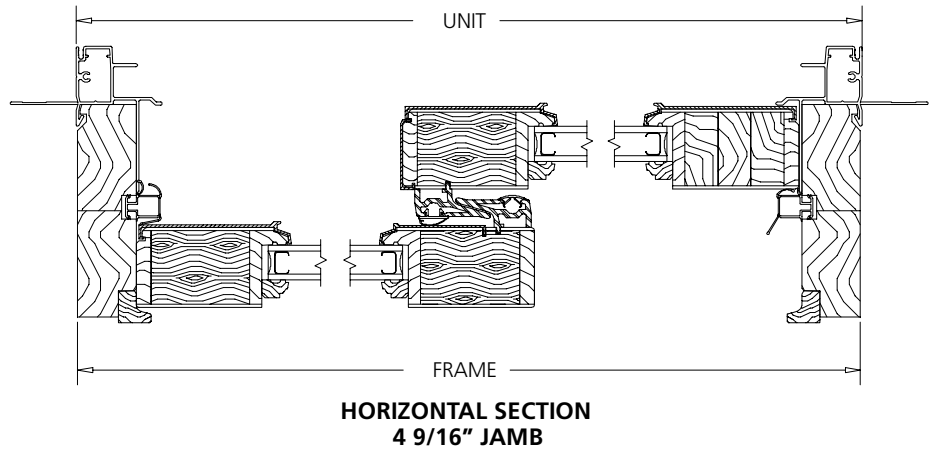
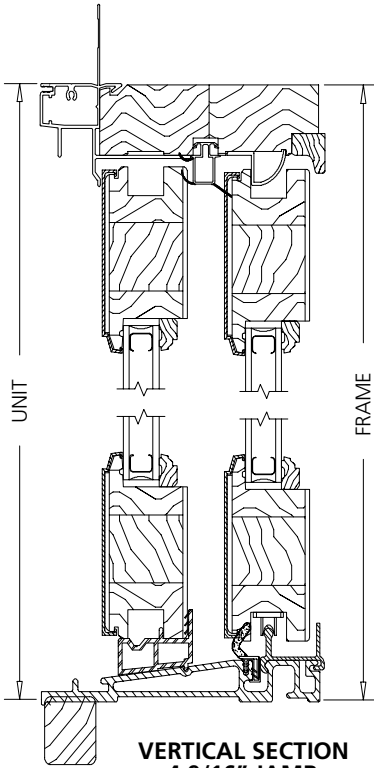

SCALE: 3" = 1'

300 SERIES 4-PANEL SLIDING PATIO DOOR

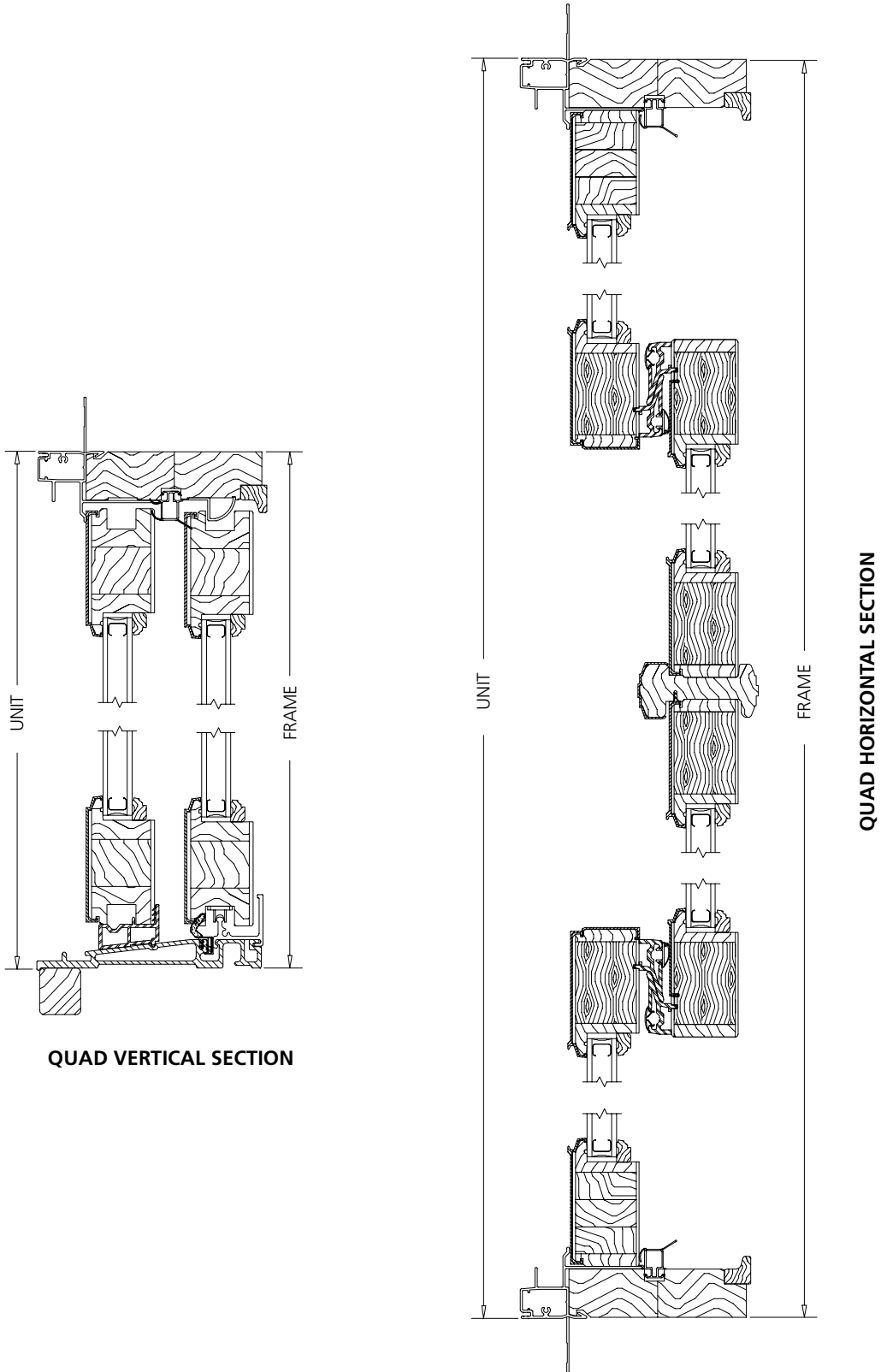

QUAD VERTICAL SECTION

QUAD HORIZONTAL SECTION

SCALE: 3" = 1'

300 SERIES SIDELIGHT

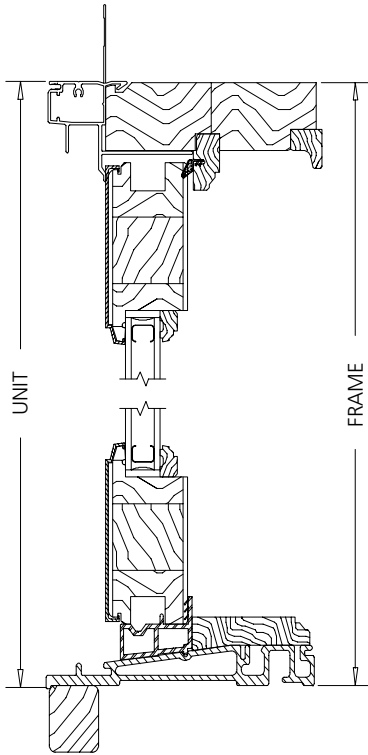

VERTICAL SECTION

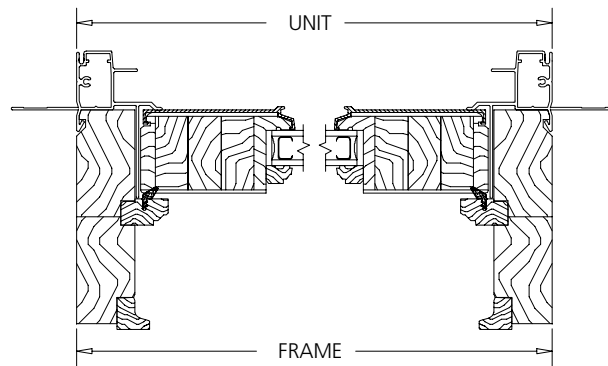

HORIZONTAL SECTION

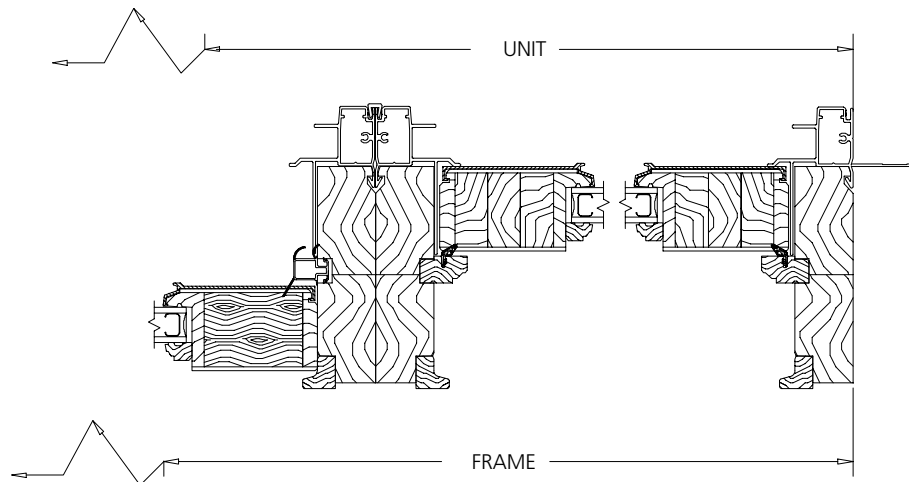

**HORIZONTAL SECTION
OPERATOR/SIDELIGHT**

SCALE: 3" = 1'

**300 SERIES SLIDING PATIO DOOR
APPLIES BRICKMOULD CASING**

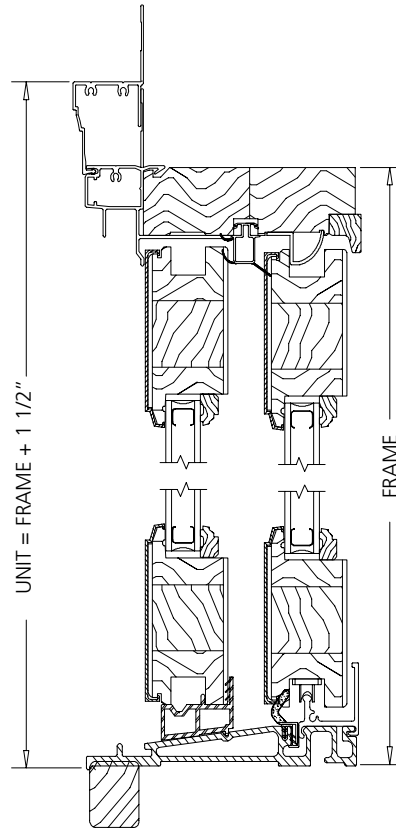

VERTICAL SECTION

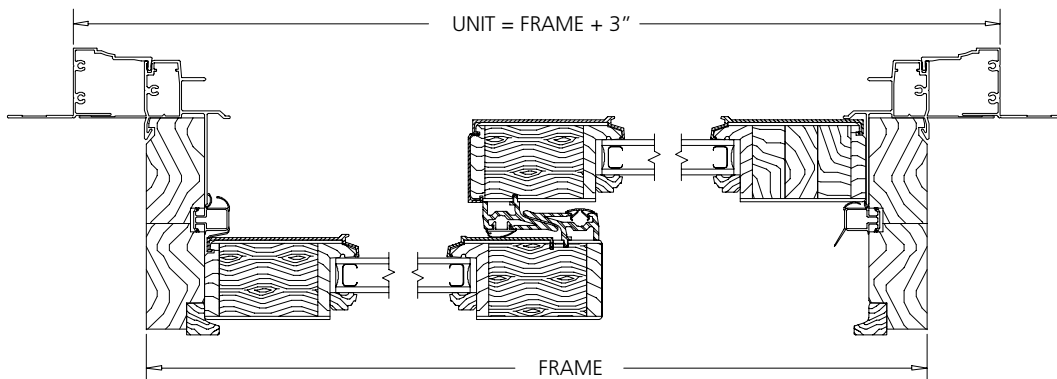

HORIZONTAL SECTION

SCALE: 3" = 1'

300 SERIES SLIDING DOOR TRANSOM

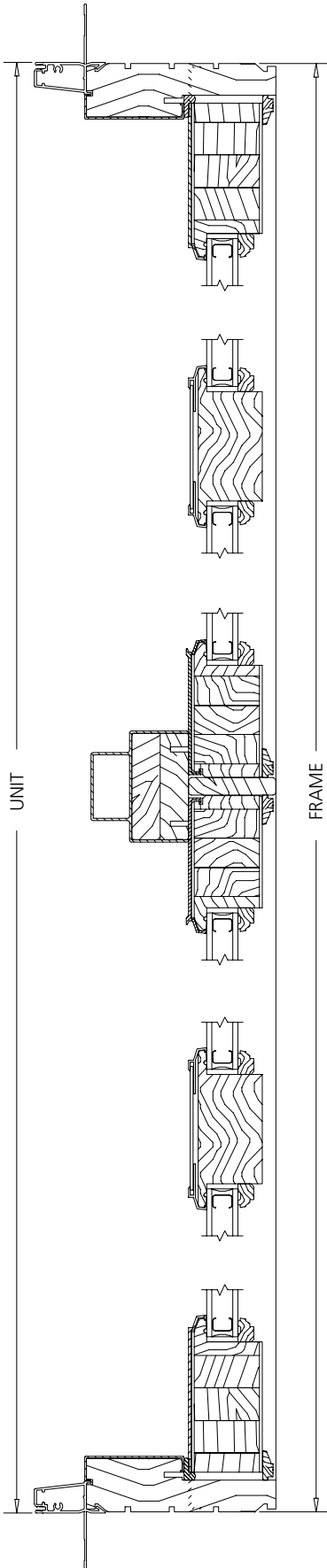

HORIZONTAL SECTION
300 SERIES SLIDING DOOR TRANSOM
2 PANEL - 4 LITE TRANSOM

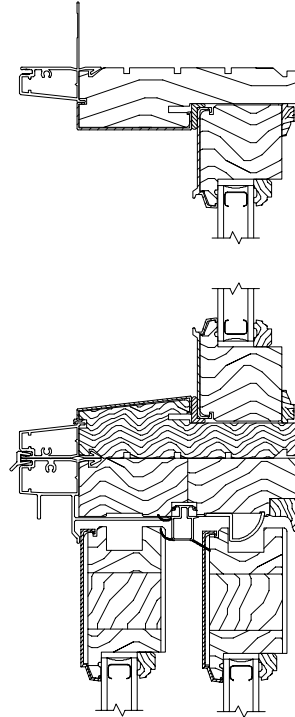

HORIZONTAL MULLION
300 SERIES SLIDING DOOR TRANSOM
MULLED ABOVE 300 SERIES SLIDING DOOR

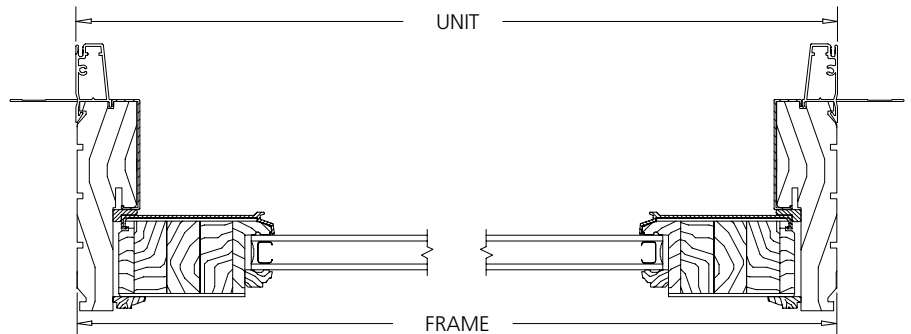

HORIZONTAL SECTION
1 PANEL

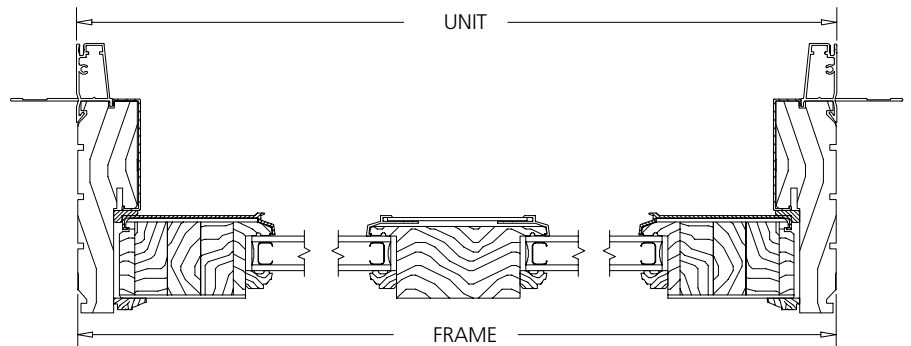

HORIZONTAL SECTION
1 PANEL 2 LITE

SCALE: 3" = 1'

400 SERIES SLIDING PATIO DOORS

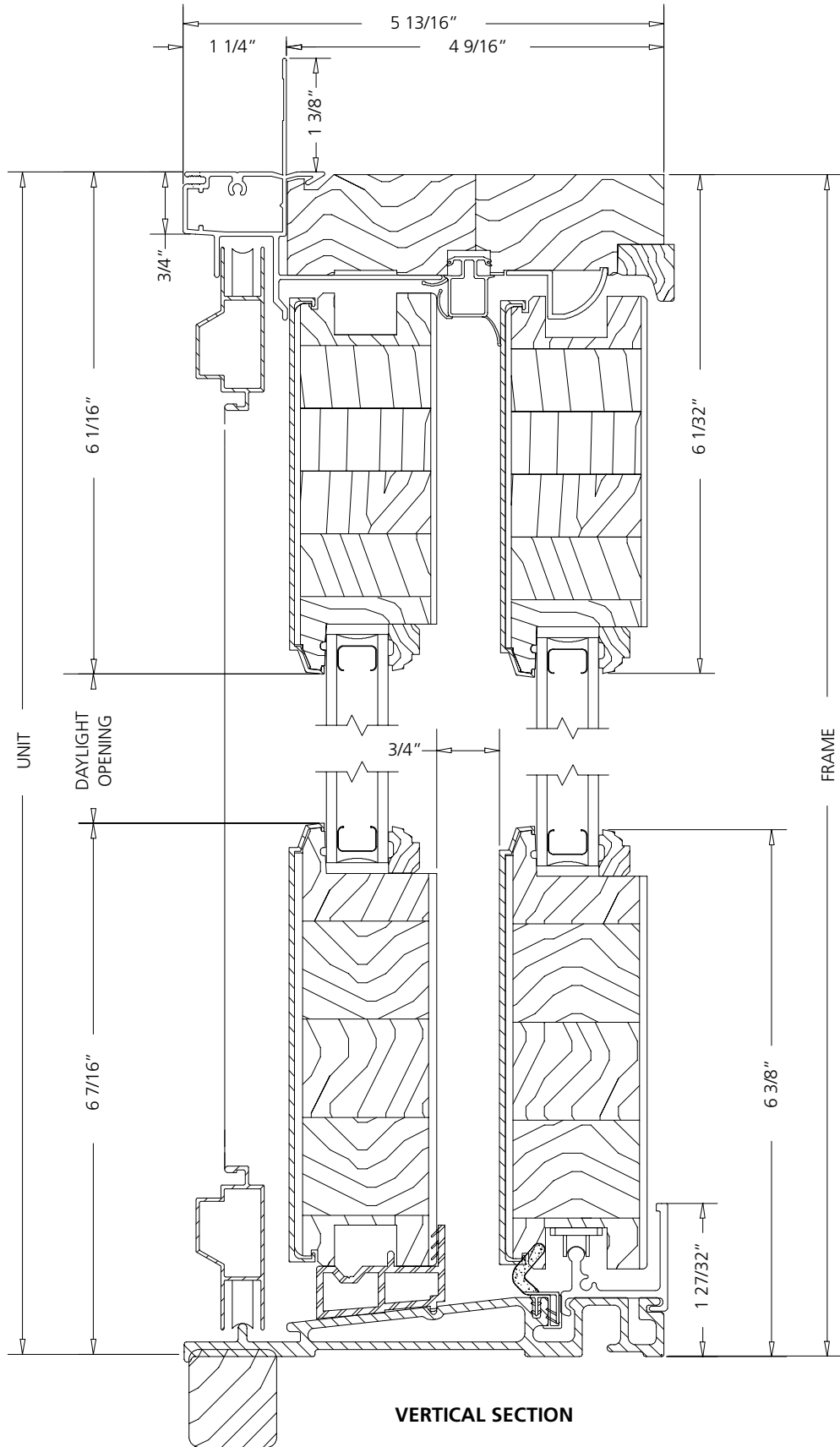

VERTICAL SECTION

SCALE: 6" = 1'

400 SERIES SLIDING PATIO DOORS

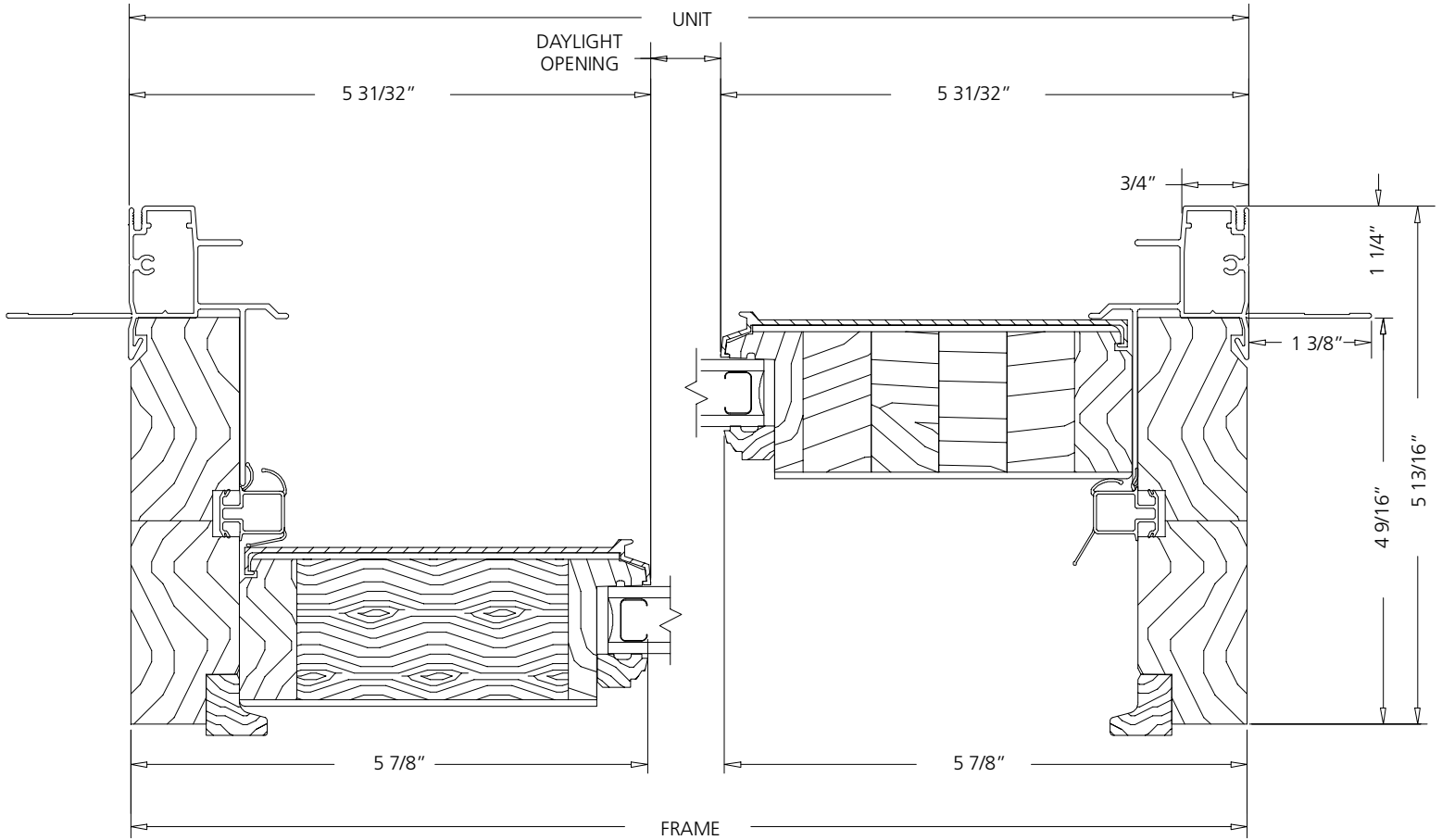

HORIZONTAL SECTION

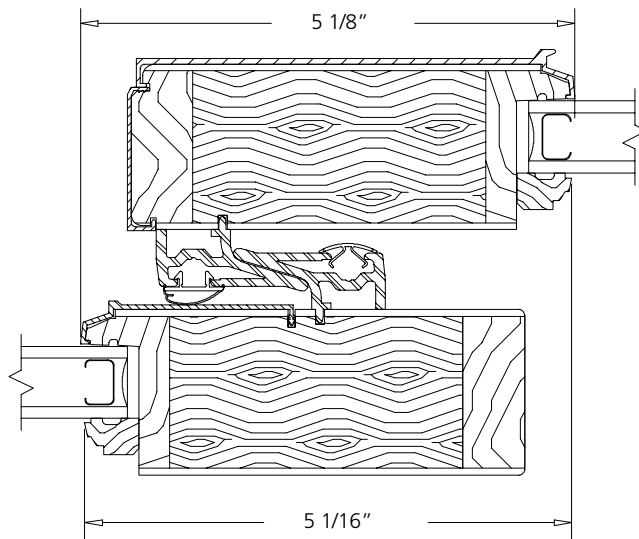

INTERLOCK SECTION

SCALE: 6" = 1'

400 SERIES SIDELIGHT

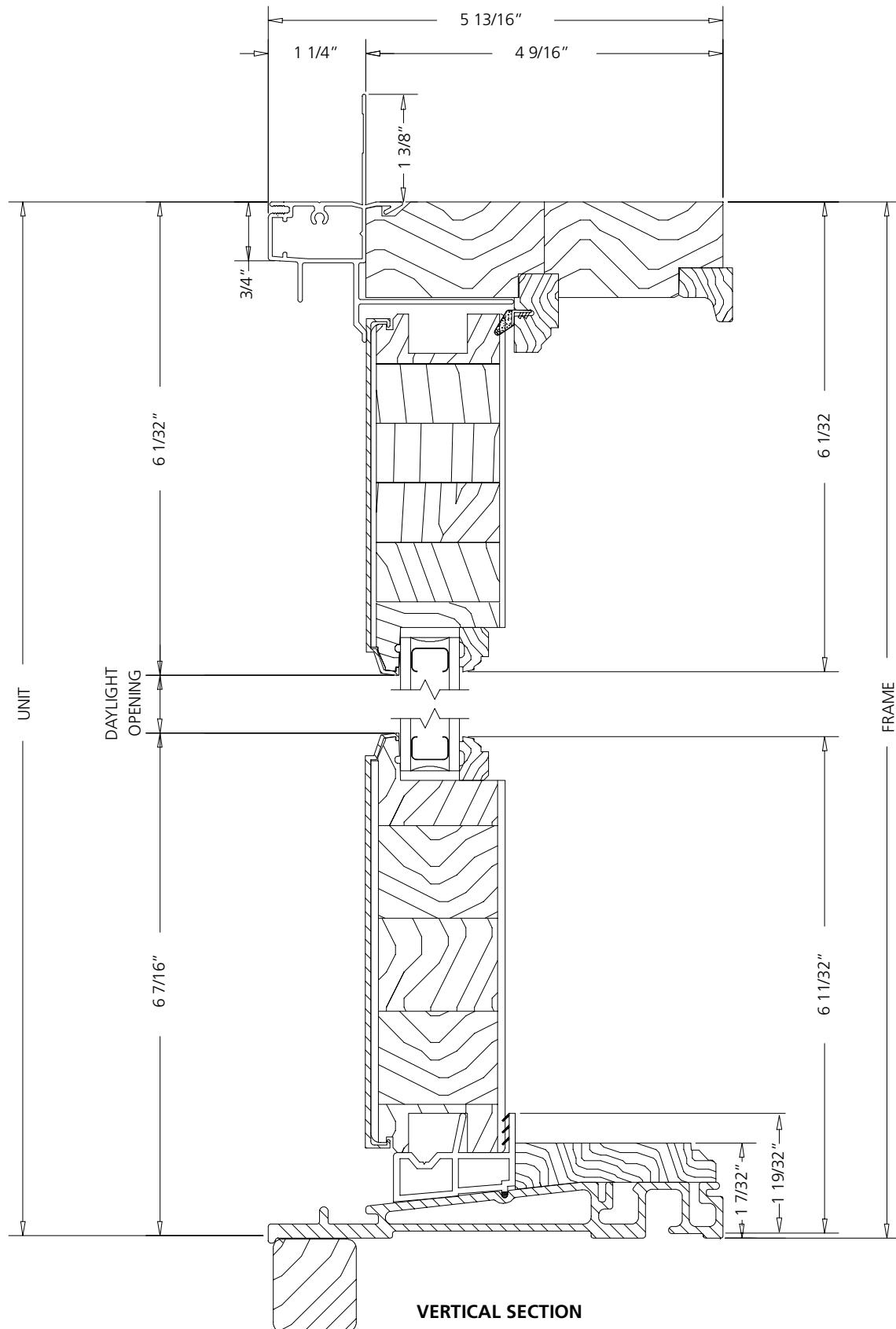

Note: Bottom rail shown is for 6'-8" units. Bottom rail is 3" taller for doors over 6'-8".

SCALE: 6" = 1'

400 SERIES SIDELIGHT

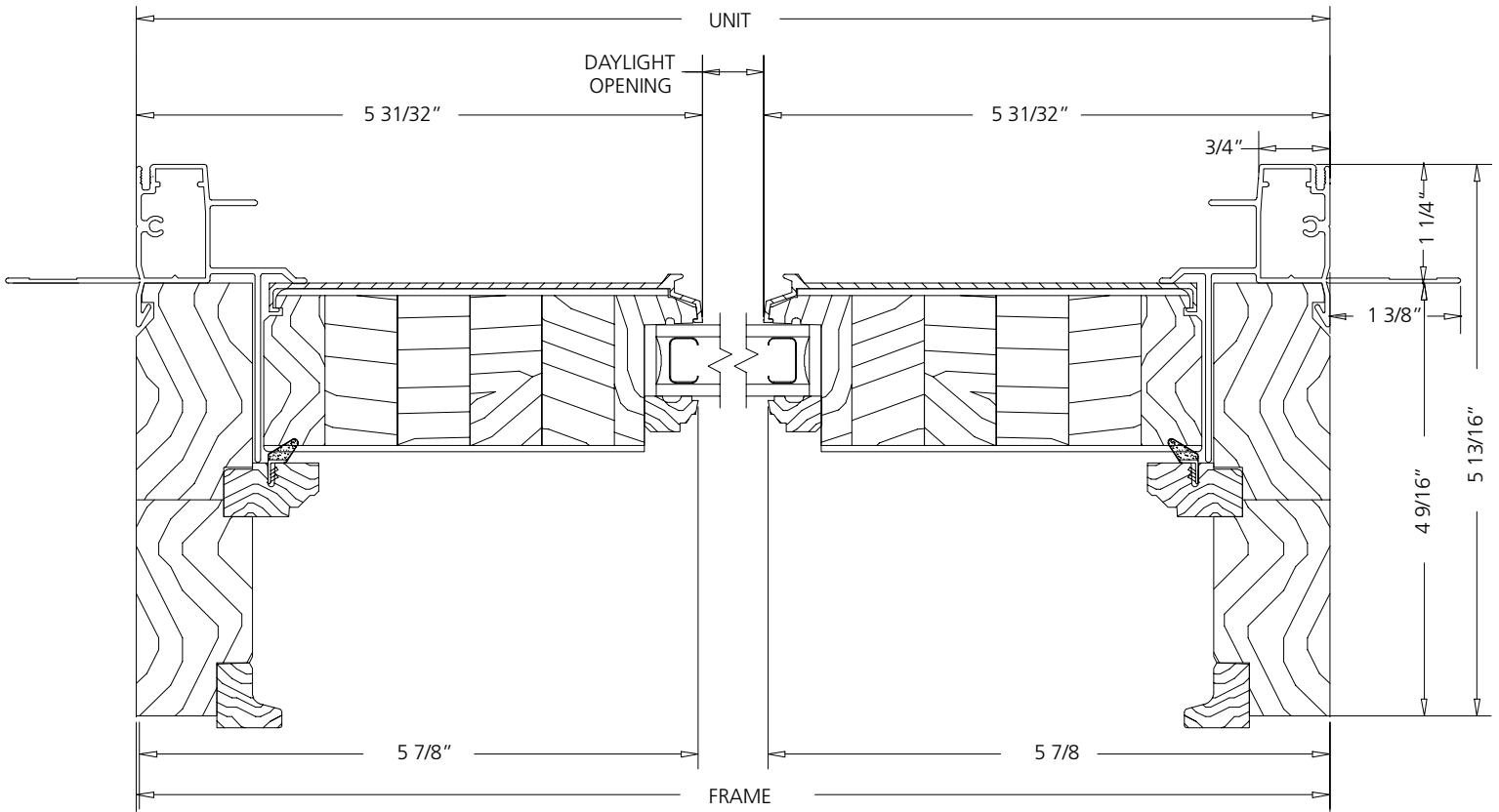

HORIZONTAL SECTION

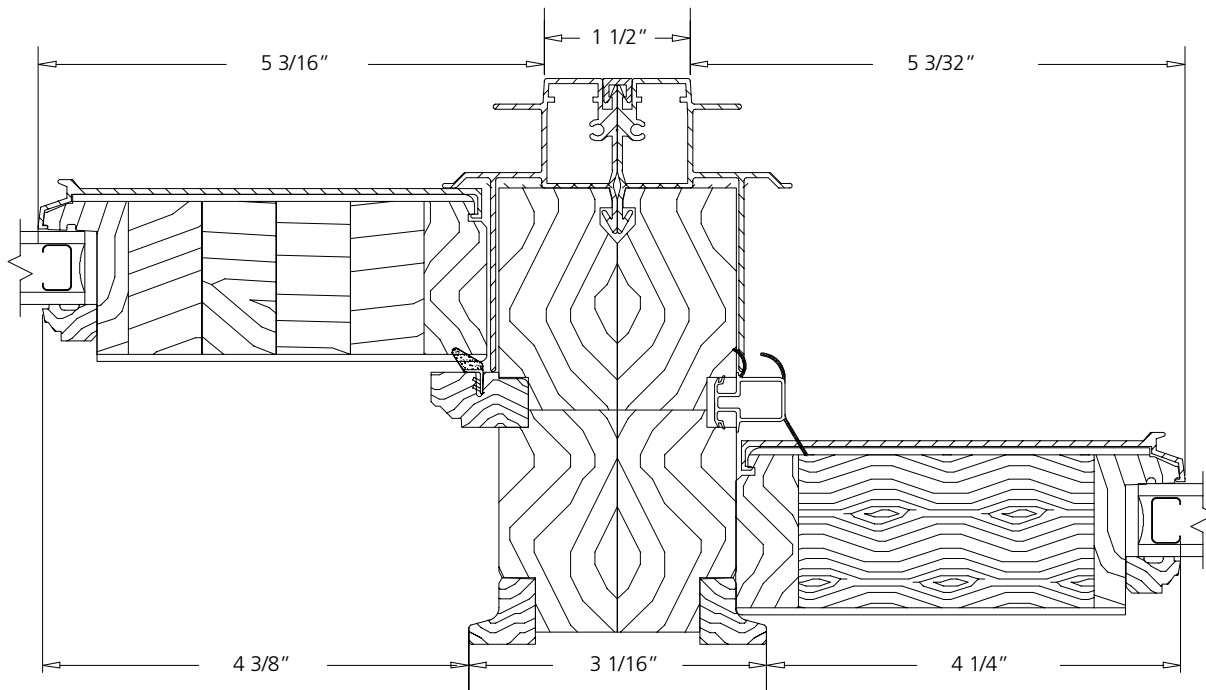

**VERTICAL MULLION
SIDELITE/OPERATOR**

SCALE: 6" = 1'

400 SERIES 4-PANEL SLIDING PATIO DOOR

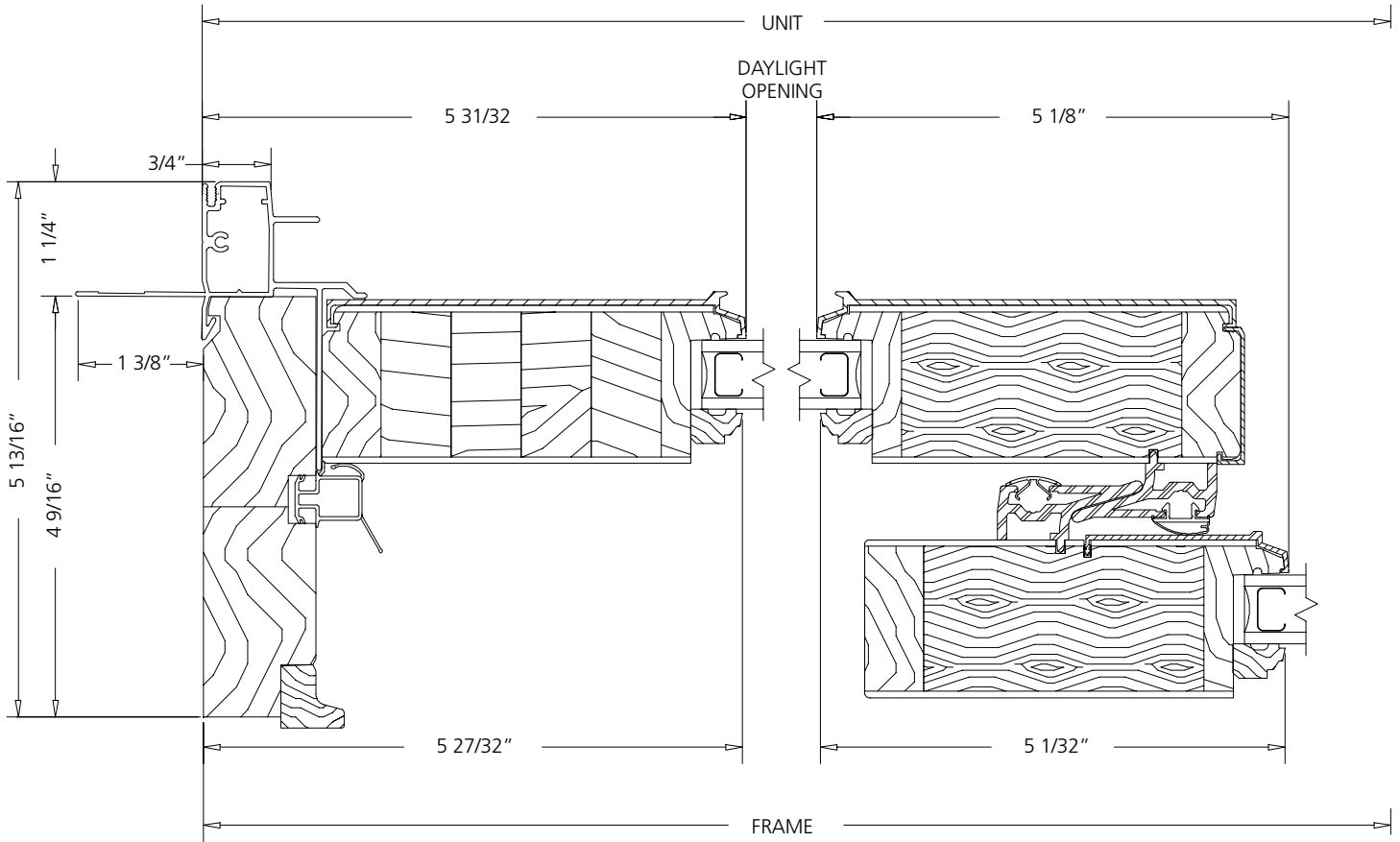

HORIZONTAL SECTION

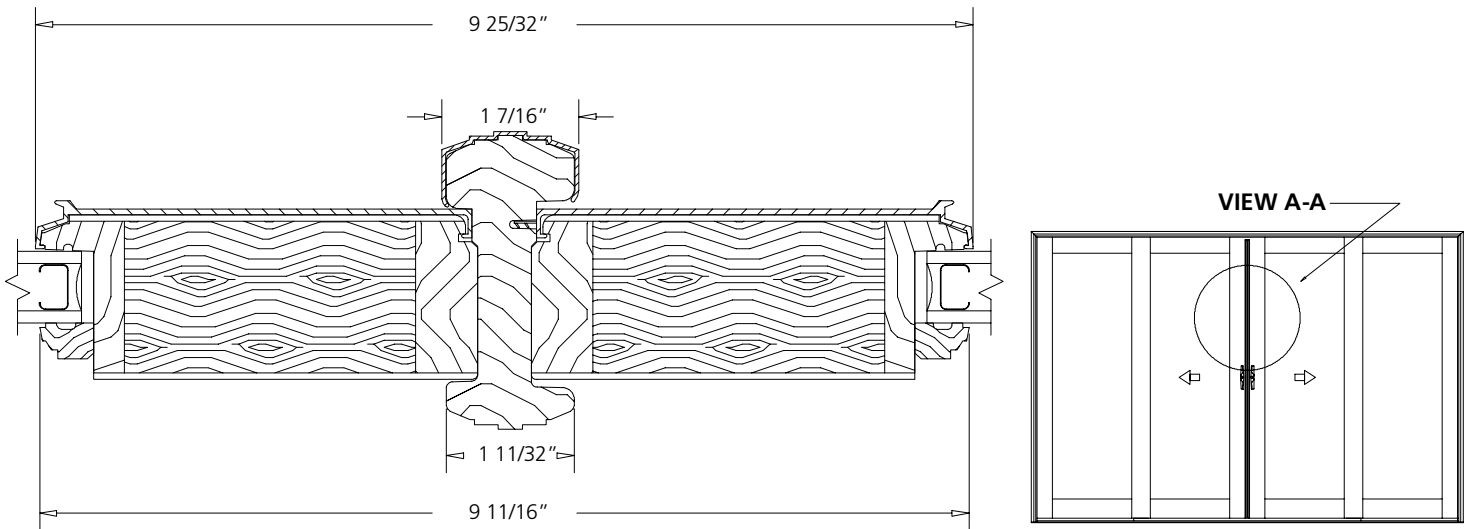

**ASTRAGAL DETAIL
VIEW A-A**

SCALE: 6" = 1'

400 SERIES SLIDING DOOR TRANSOM

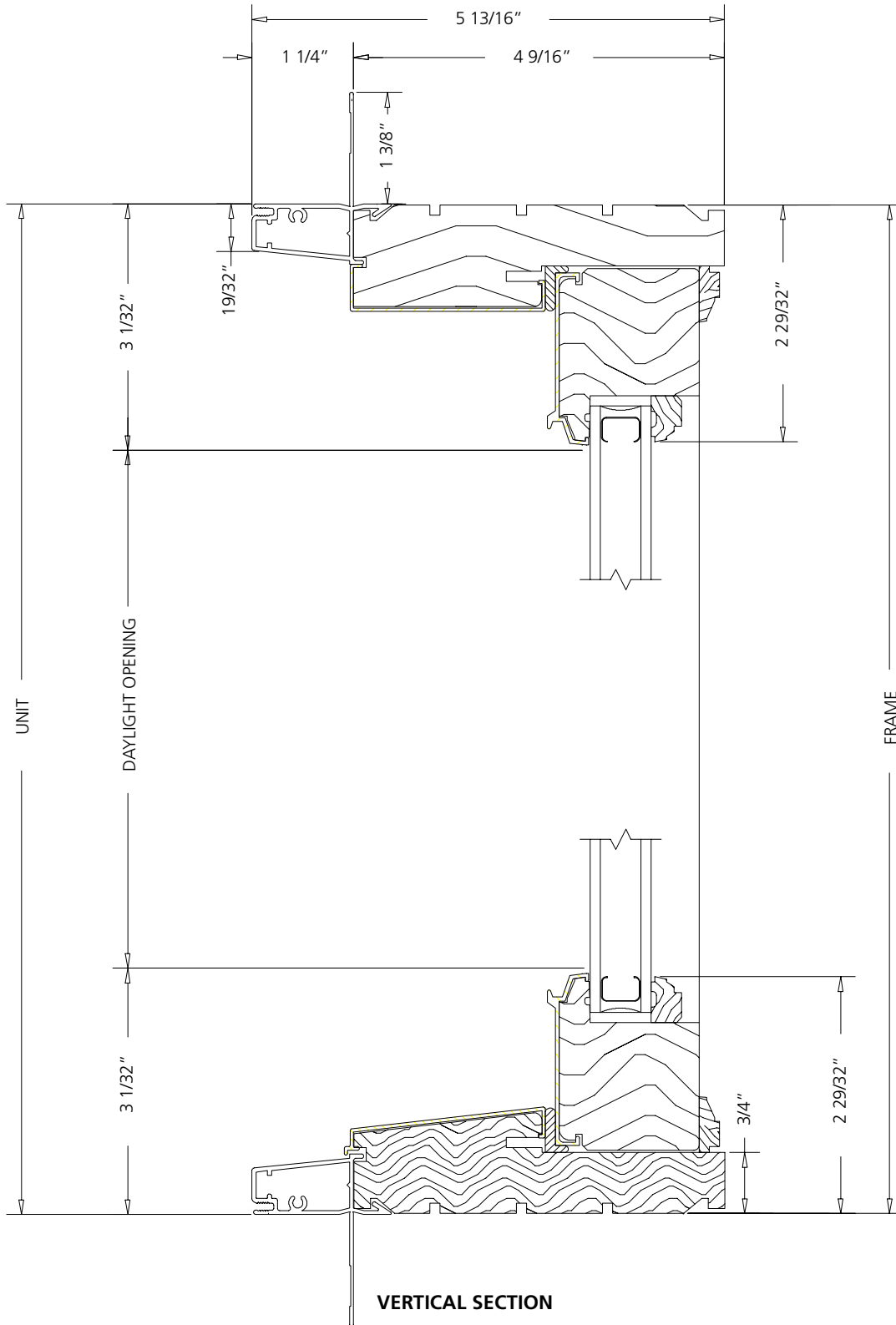

SCALE: 6" = 1'

400 SERIES SLIDING DOOR TRANSOM

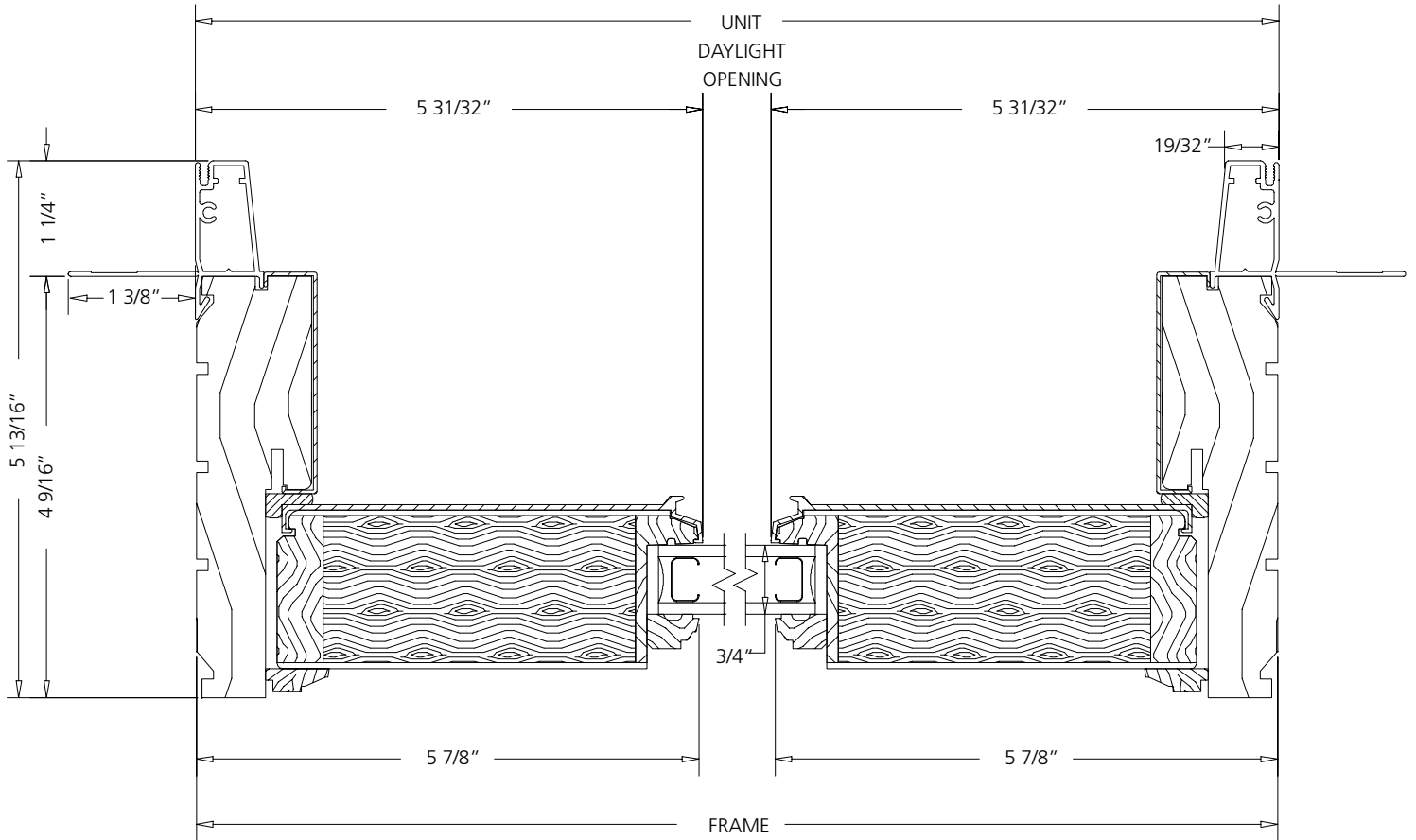

HORIZONTAL SECTION

400 SERIES SLIDING DOOR JAMB DETAILS

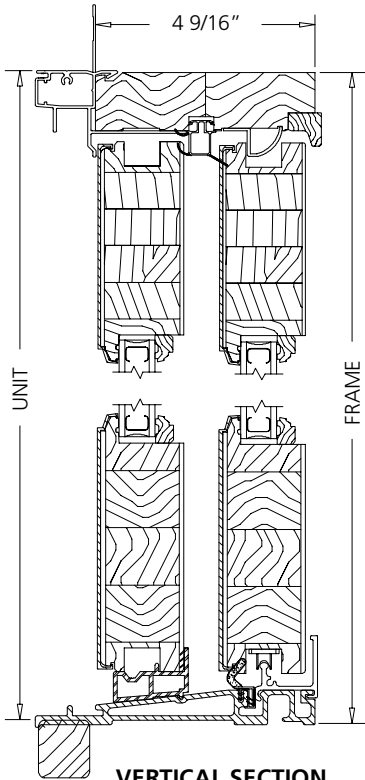

**VERTICAL SECTION
4 9/16" JAMB**

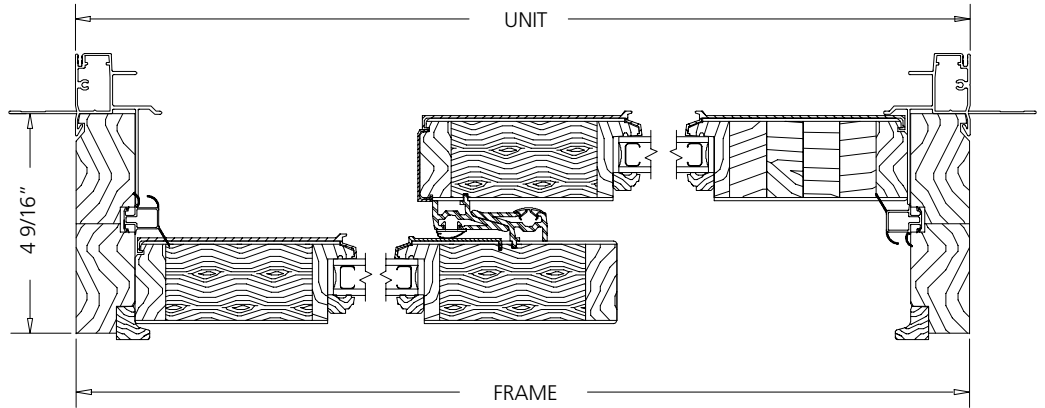

**HORIZONTAL SECTION
4 9/16" JAMB**

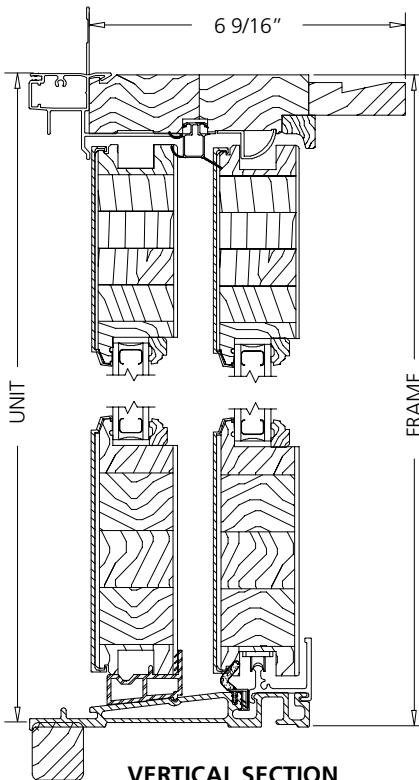

**VERTICAL SECTION
6 9/16" JAMB**

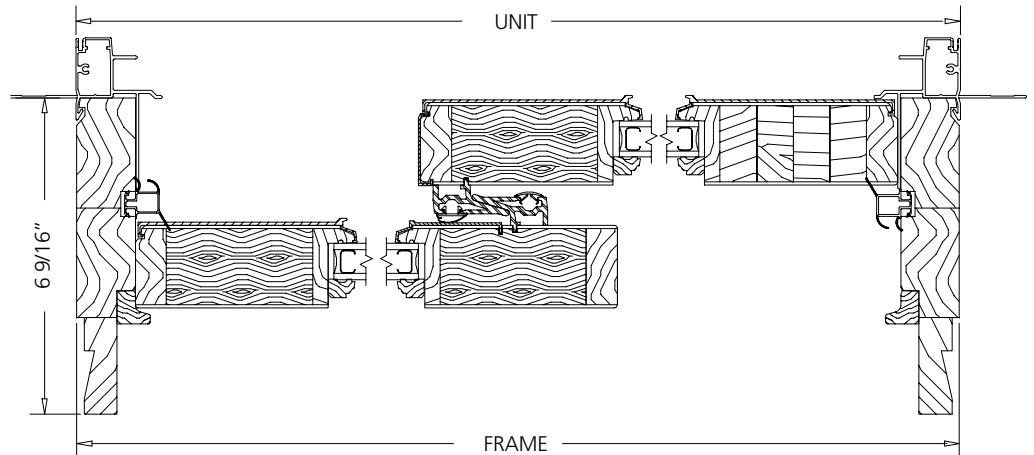

**HORIZONTAL SECTION
6 9/16" JAMB**

SCALE: 3" = 1'

400 SERIES 4-PANEL SLIDING DOOR

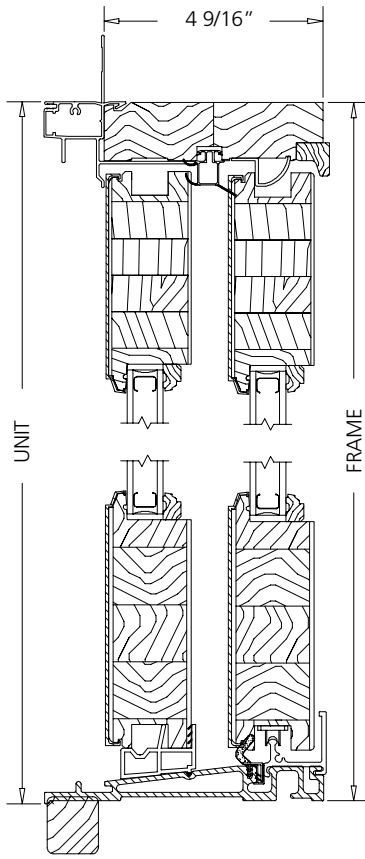

QUAD VERTICAL SECTION

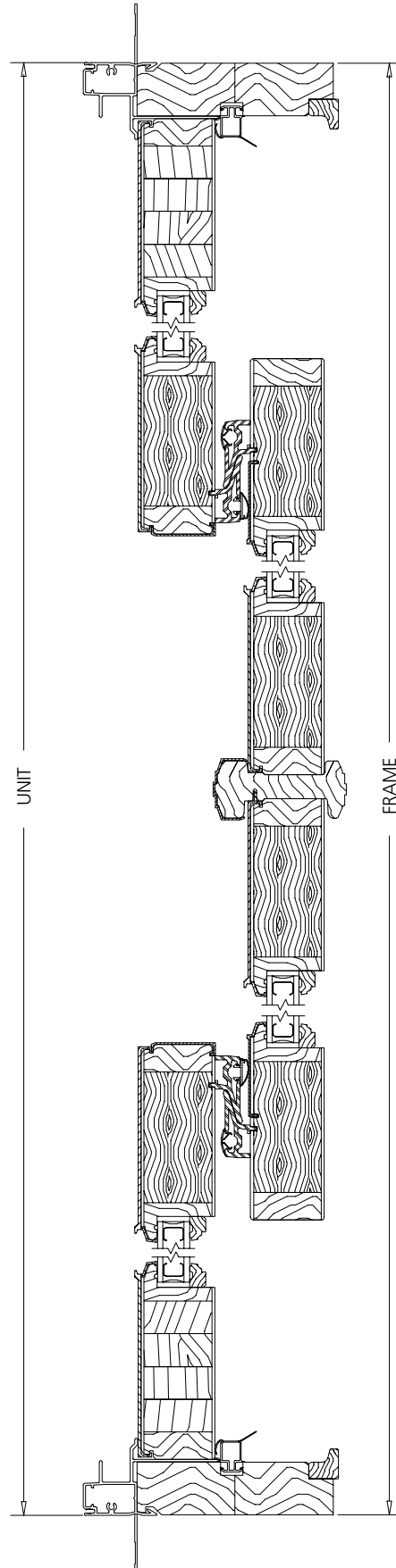

QUAD HORIZONTAL SECTION

SCALE: 3" = 1'

400 SERIES SIDELIGHT

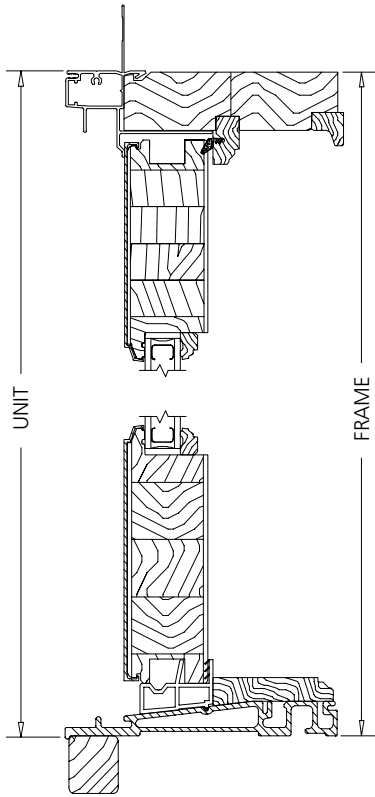

VERTICAL SECTION

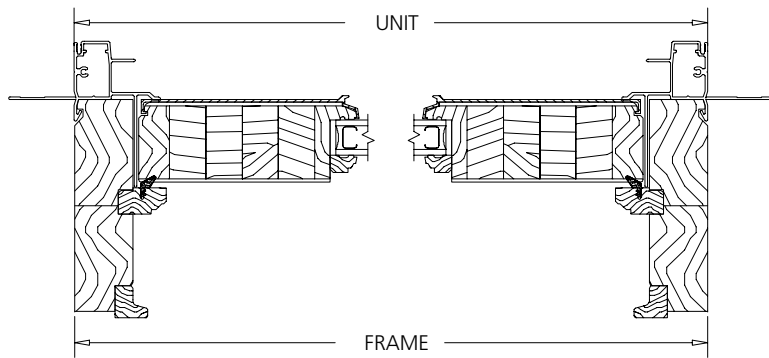

HORIZONTAL SECTION

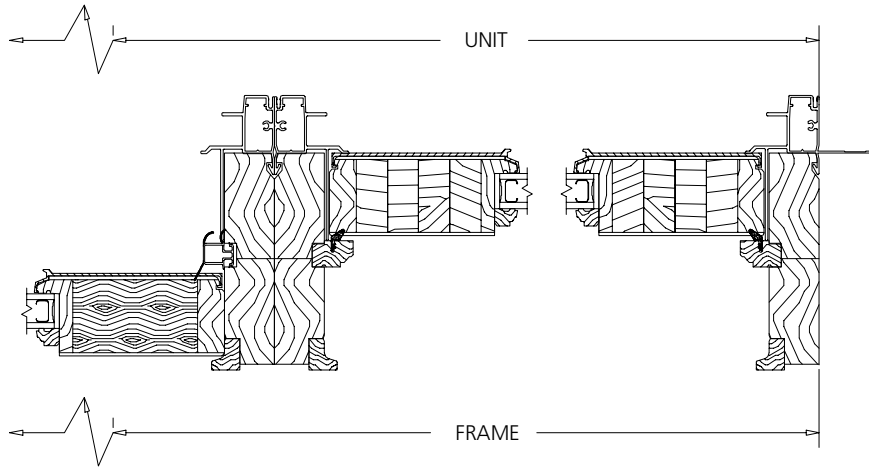

**VERTICAL MULLION
OPERATOR/SIDELIGHT**

SCALE: 3" = 1'

**400 SERIES SLIDING PATIO DOOR
WITH BRICKMOULD CASING**

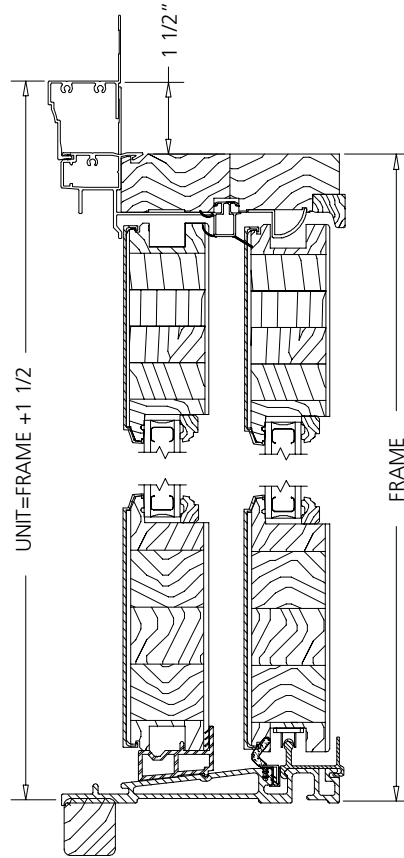

VERTICAL SECTION

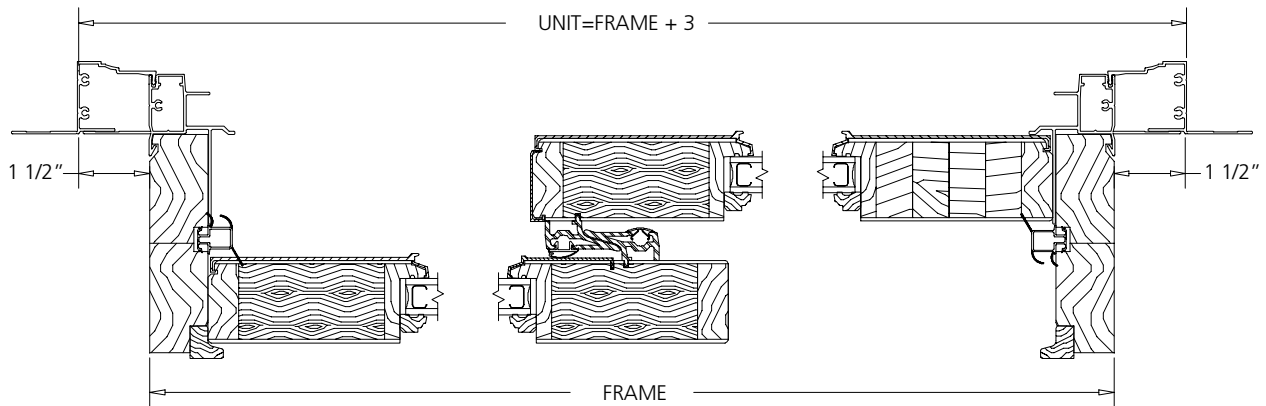

HORIZONTAL SECTION

SCALE: 3" = 1'

400 SERIES SLIDING DOOR TRANSOMS

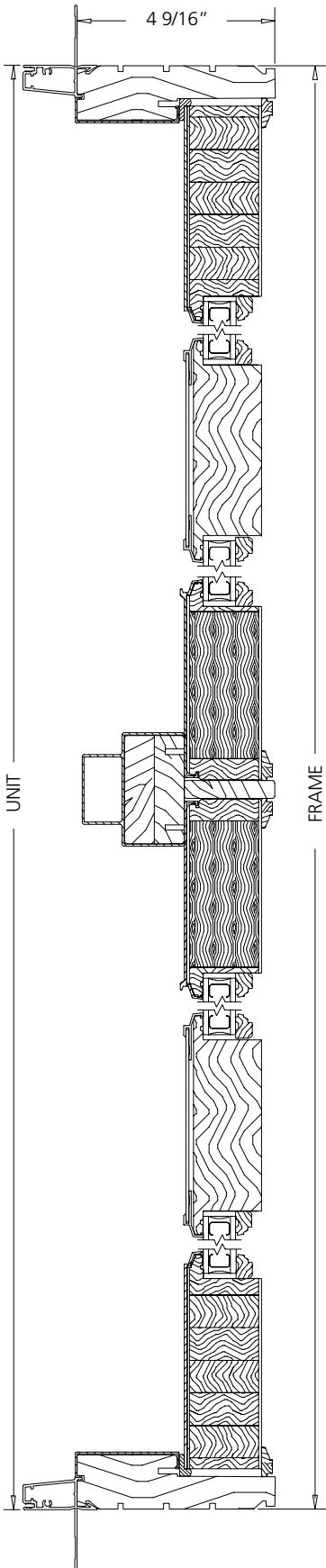

**HORIZONTAL SECTION
400 SERIES SLIDING DOOR TRANSOM
2 PANEL - 4 LITE TRANSOM**

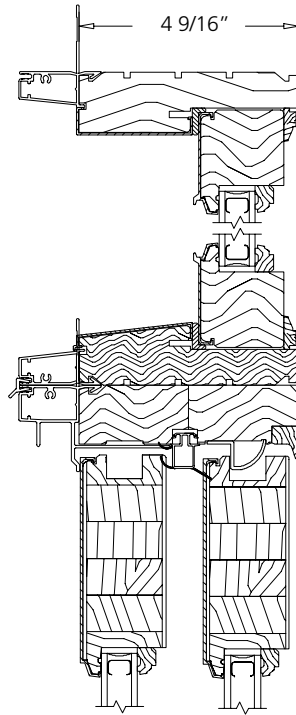

**HORIZONTAL MULLION
400 SERIES SLIDING DOOR TRANSOM
MULLED ABOVE 400 SERIES SLIDING DOOR**

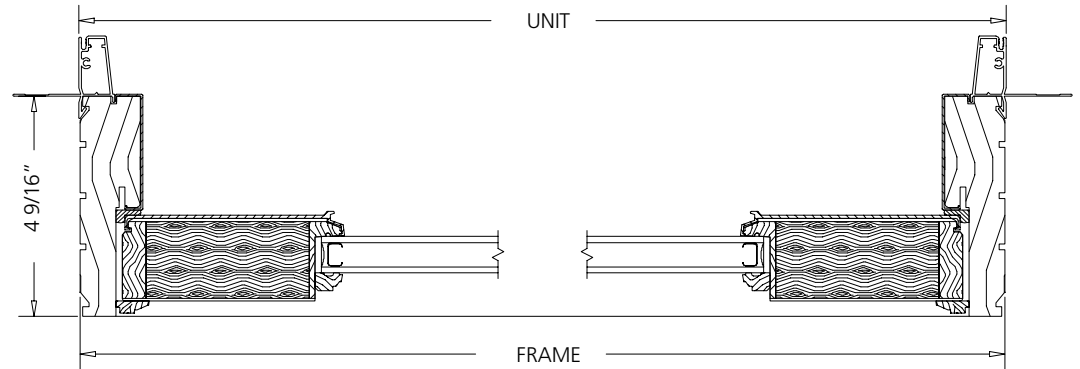

**HORIZONTAL SECTION
1 PANEL**

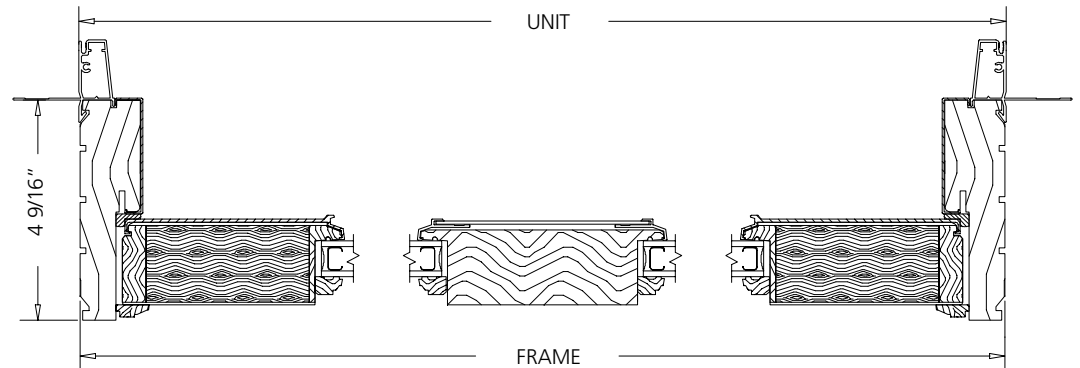

**HORIZONTAL SECTION
1 PANEL 2 LITE**

SCALE: 3" = 1'